

A	B	C1	C2	C3	D
1	M244-4301	500	850	19	1/1
2	M244-5563	1010	80	22,	1/1
3	M244-5566	480	80	22,	1/1

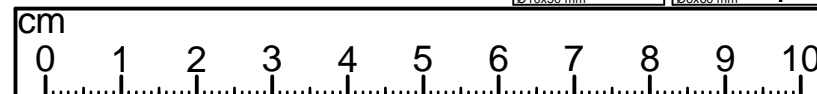

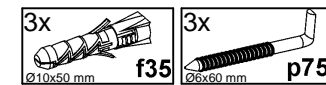
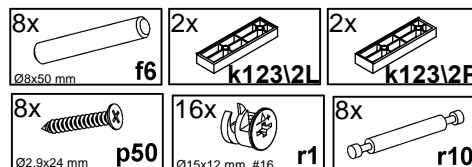
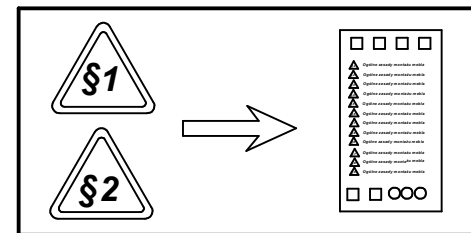
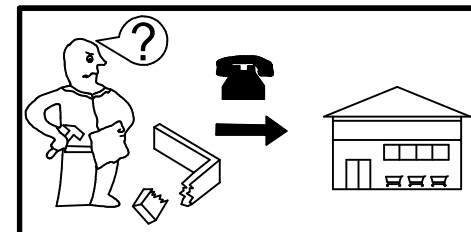
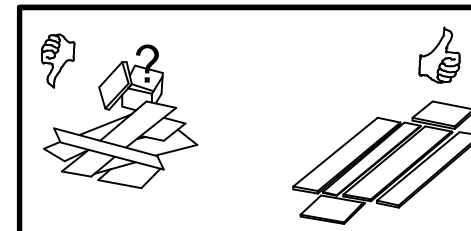
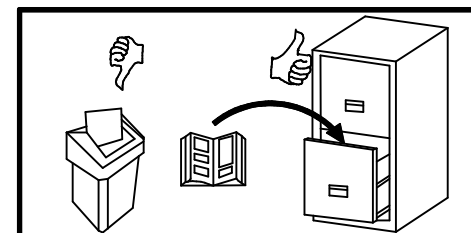
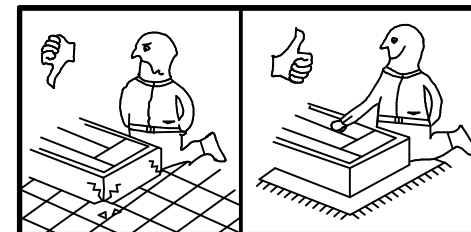
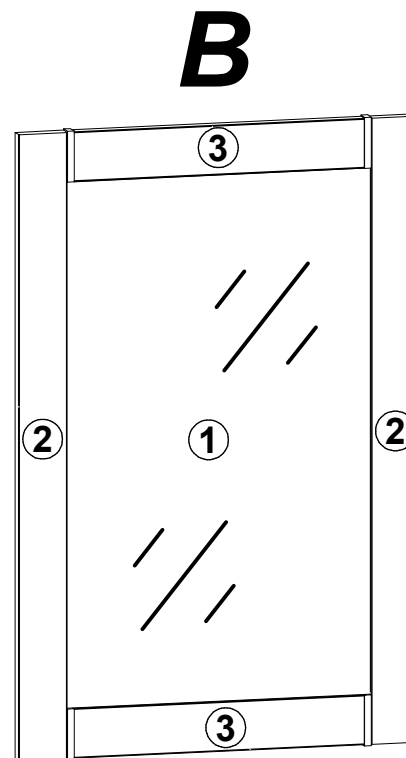
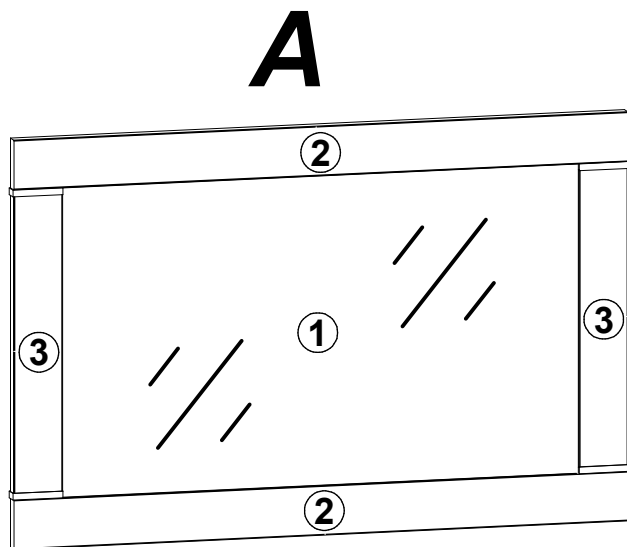
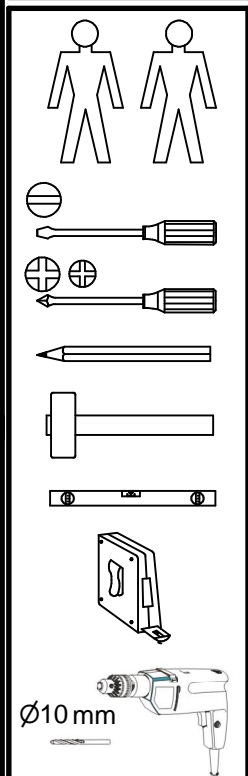
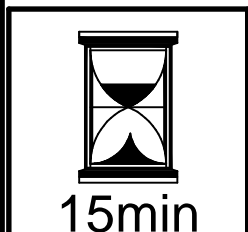
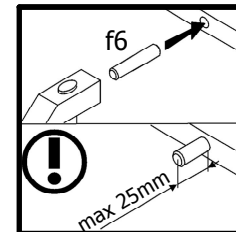
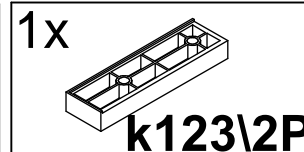
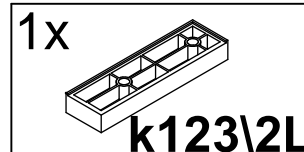
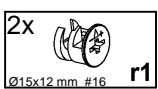
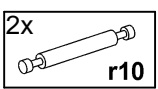
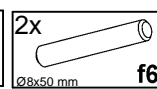
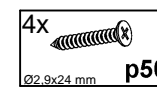
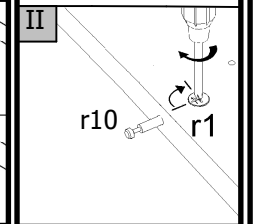
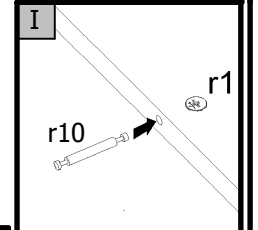
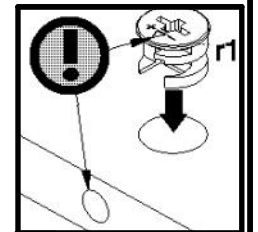
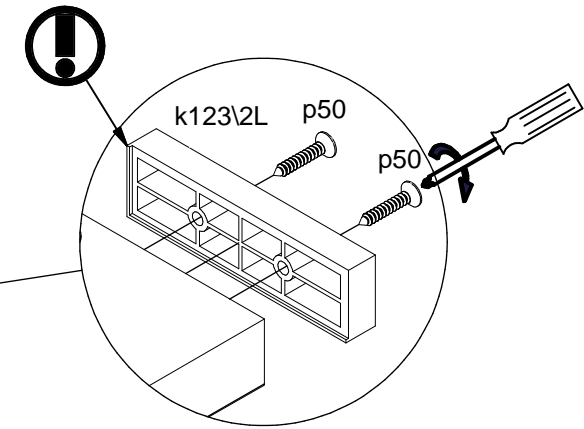
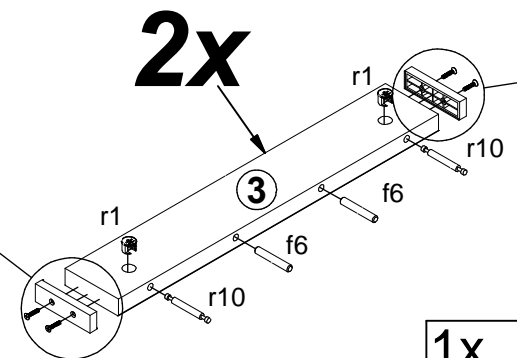
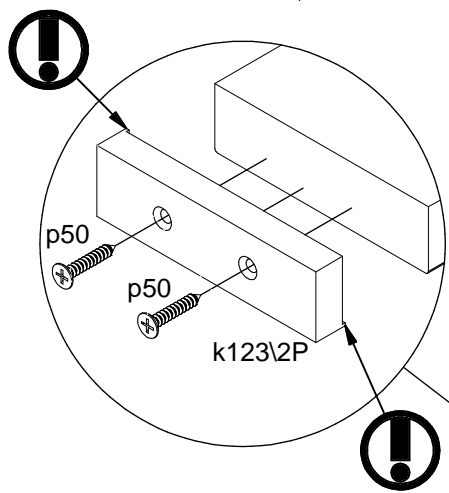
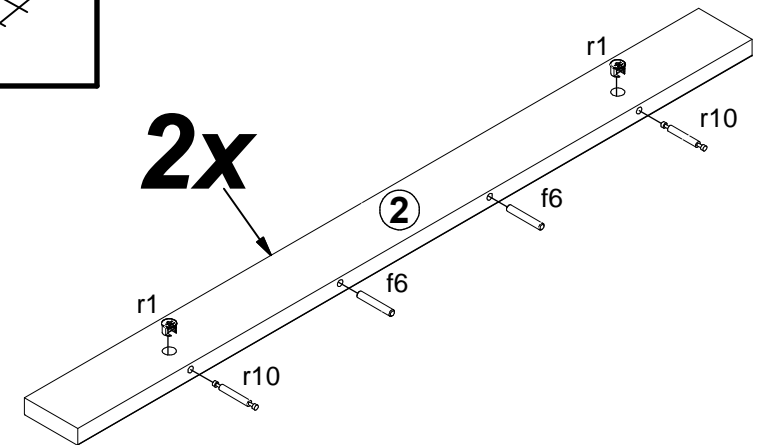
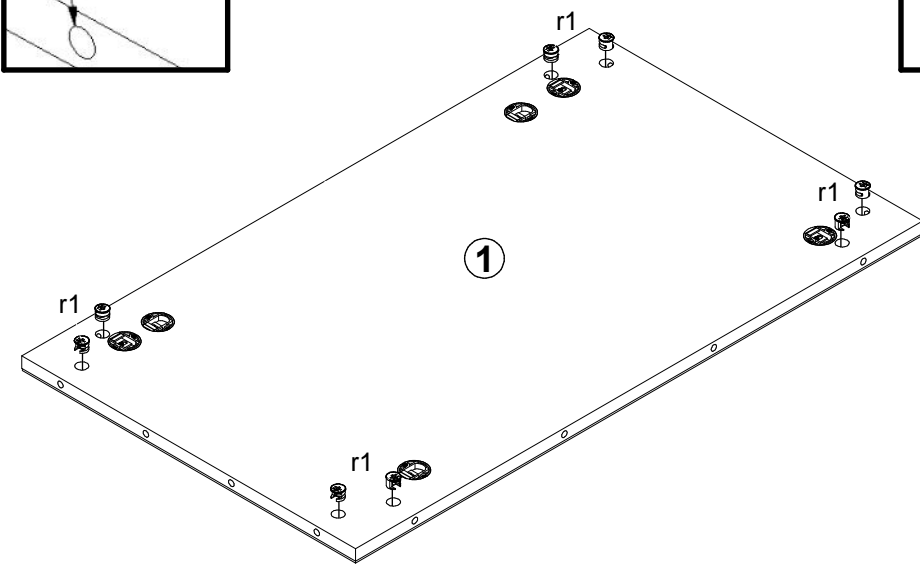
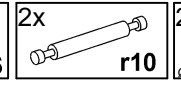
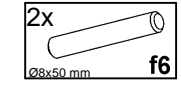
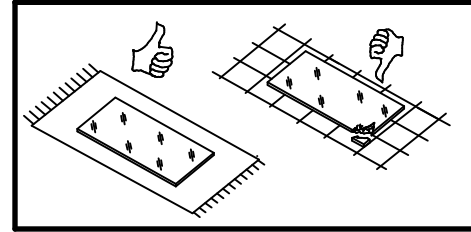
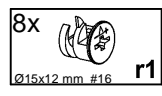
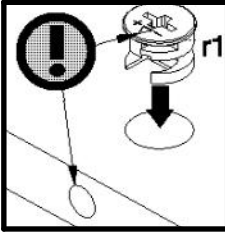

A

M244-LUS/7/10

3 / 4

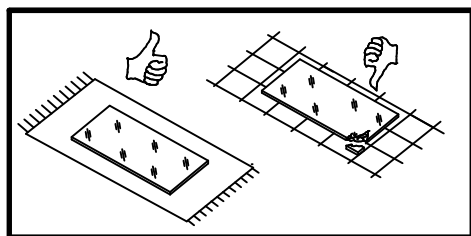
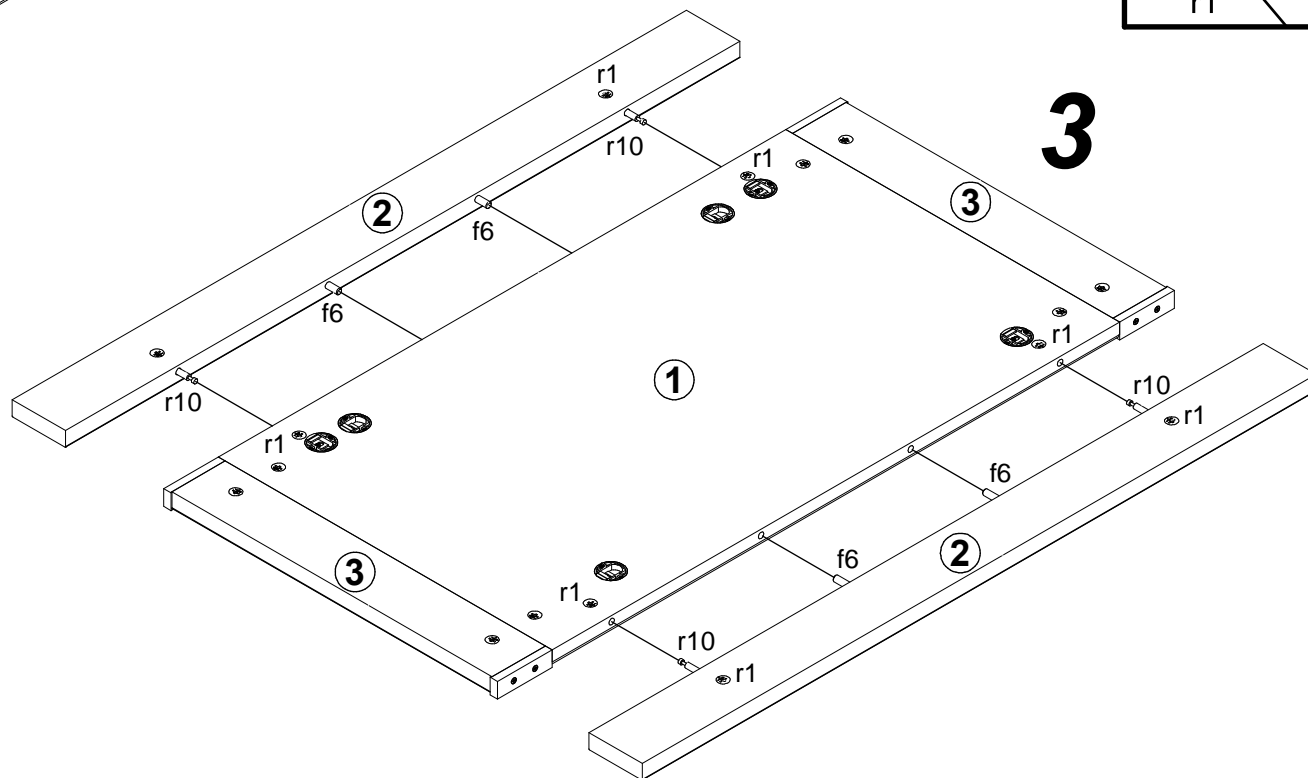
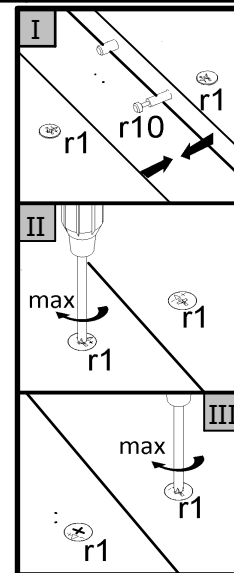
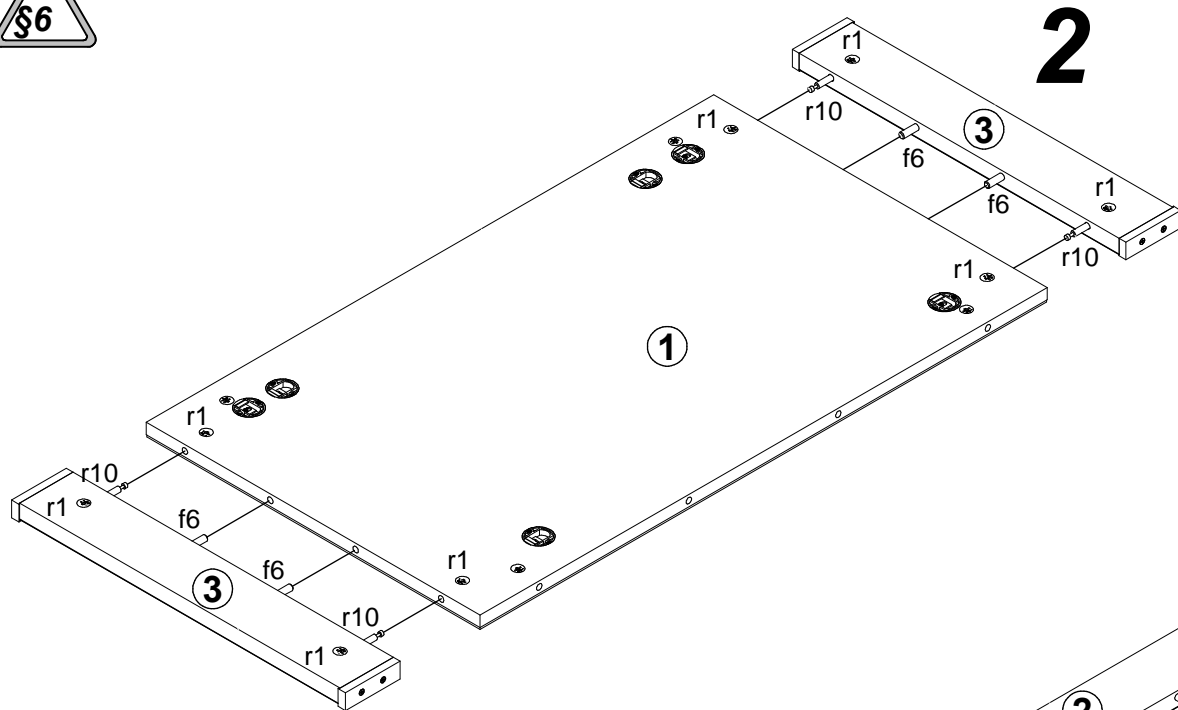

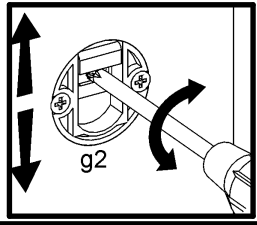
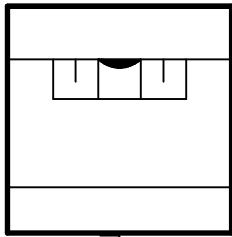

φ10 mm

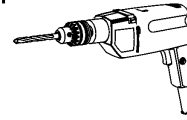

f35

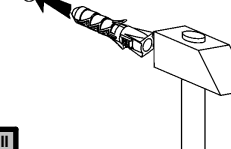

f35

p75

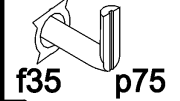

A

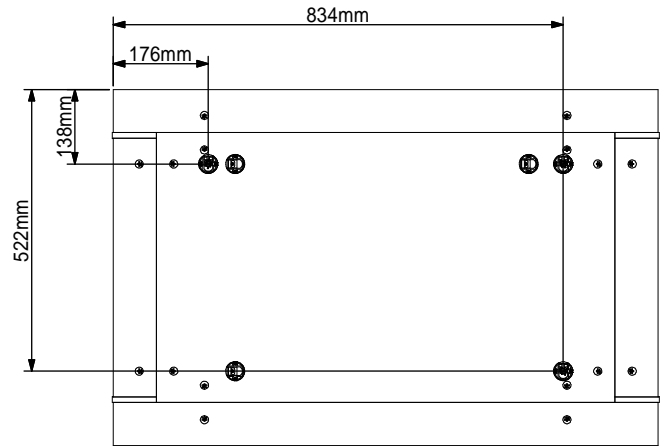
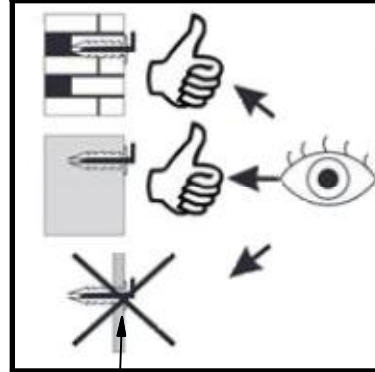
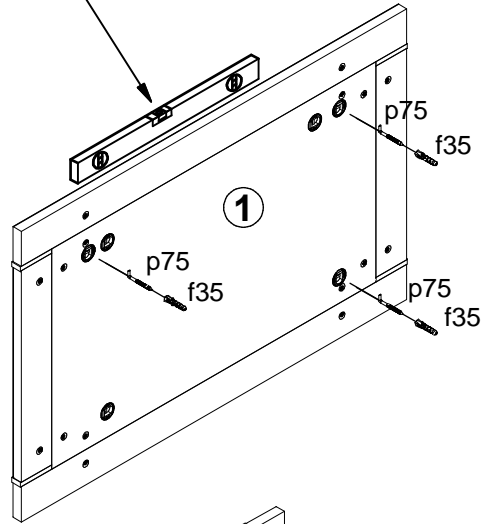

A



B

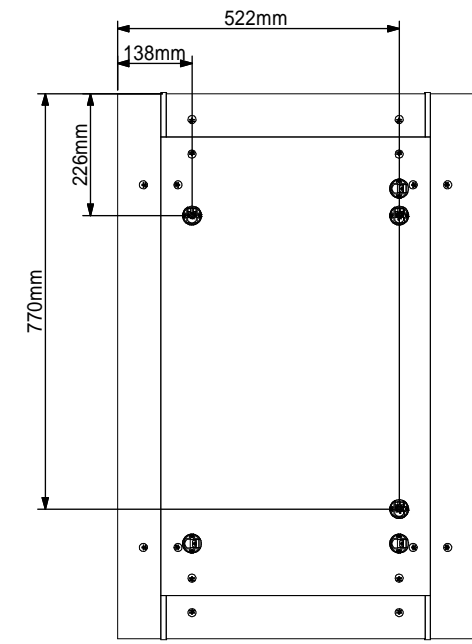
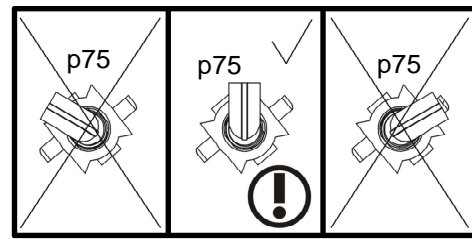
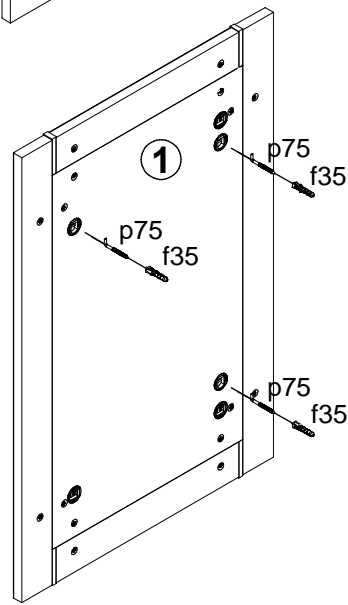

B

