

SK NÁVOD NA MONTÁŽ  
 CZ MONTÁŽNÍ NÁVOD  
 HU SZERELÉSI UTASÍTÁS  
 DE MONTAGEANLEITUNG

# RIOMA TYP 05

	750	mm
	2178	
	380	

	100 min		PZ 2	≤ 0,5 kg	3m



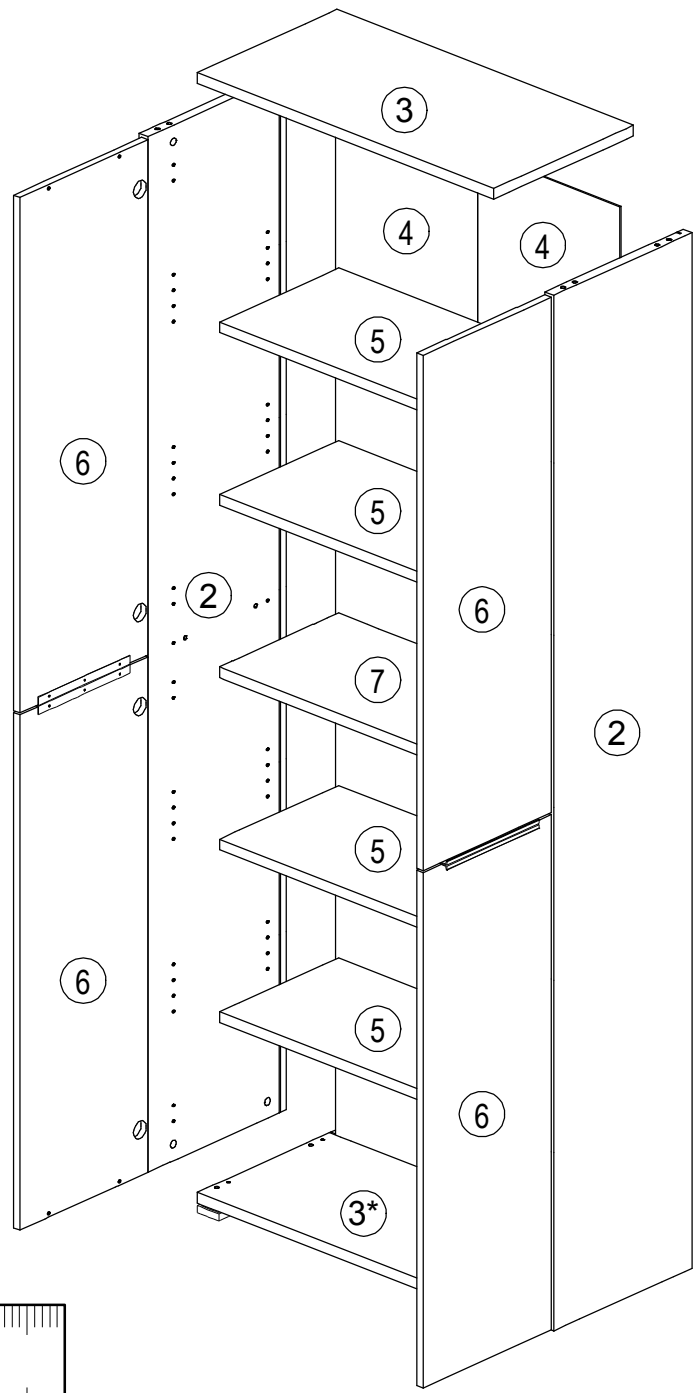
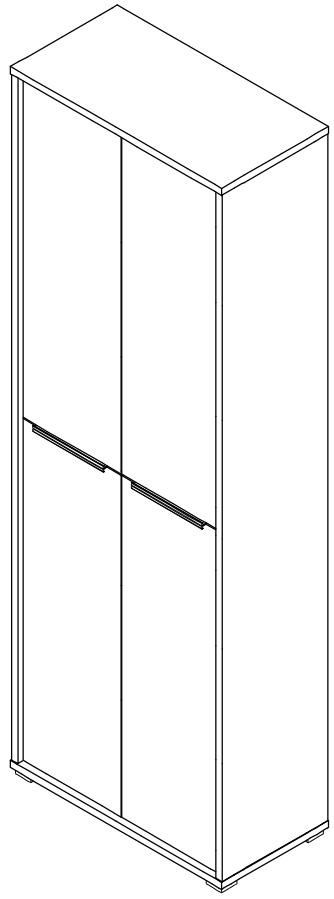





ID	ID	Image	Quantity	Ratio
12788	2		2x	1/3
12789	3		2x	2/3
12790	4		2x	1/3
12791	5		4x	2/3
12806	6		4x	3/3
13057	7		1x	2/3

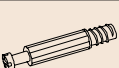
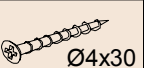

 22244,01 Ø3,5*16	 27000,00 Ø8*30	 70013,01	 70021,01	 8501,00	 22060,00 Ø4x30	 50553,00		 30083,00 55x55x20	 31103,00
A 2x	B 12x	C 12x	D 12x	E 16x	F 16x	G 16x	H 12x	J 4x	K 1x
 22213,00 Ø4x70	 24103,00 Ø8	 22243,00 Ø3,5x15	 22234,00 Ø3x12	 36001,01	 36001,01	 32242,00	 8402,03		
L 1x	M 1x	N 16x	P 12x	Q 8x	R 8x	S 4x	T 4x		

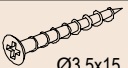
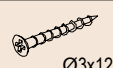
--	--	--	--	--	--	--	--	--	--

									
B 12x	C 12x	D 12x	F 16x	J 4x	N 16x	P 12x	Q 8x	R 8x	S 4x



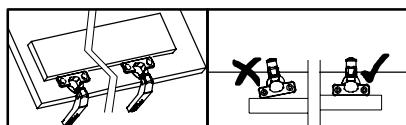
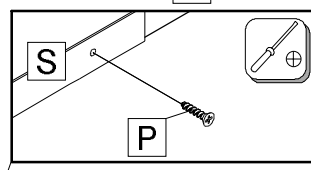
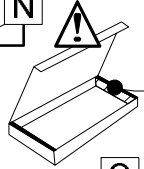
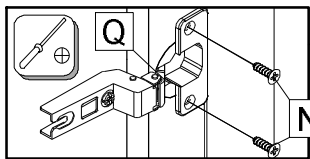
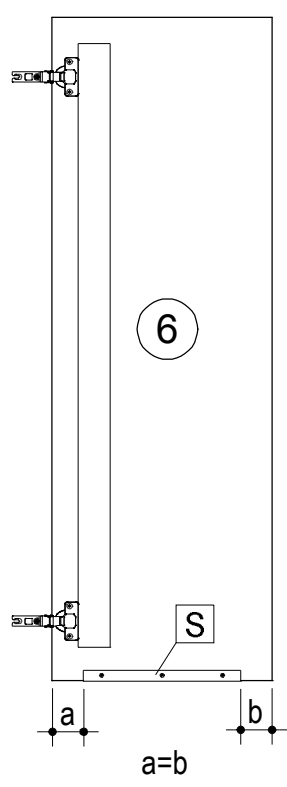
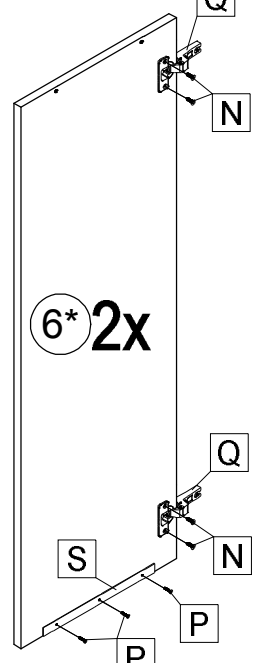
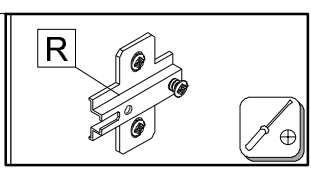
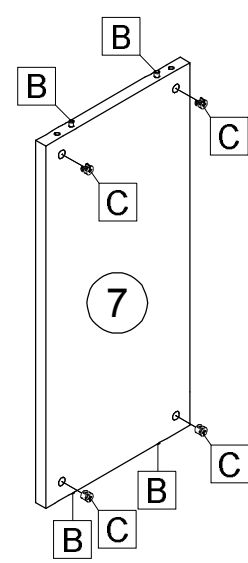
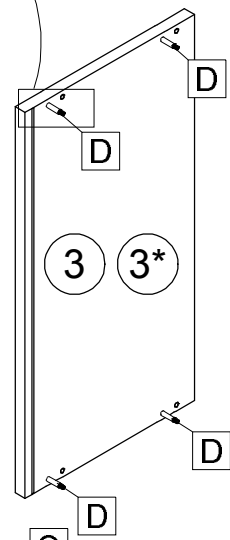
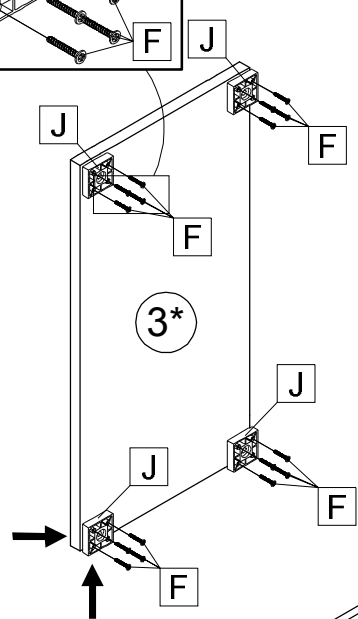
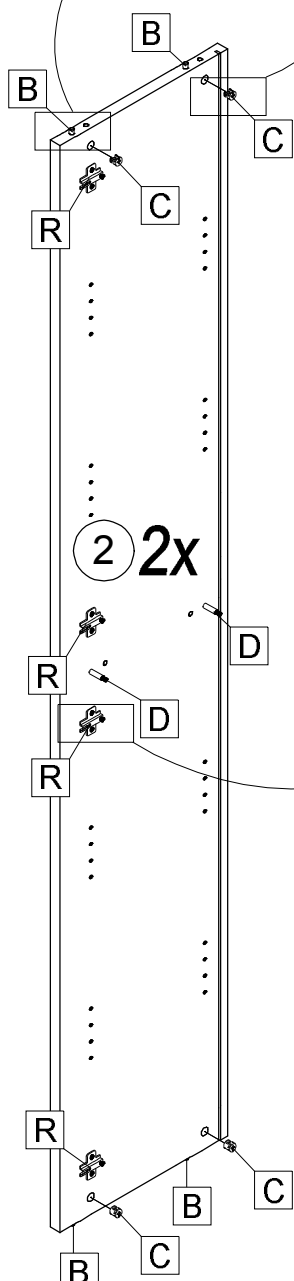
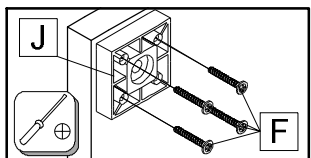
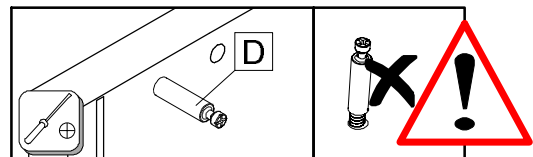
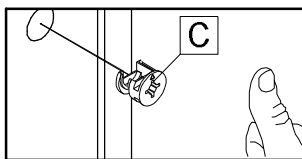
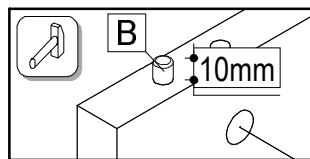

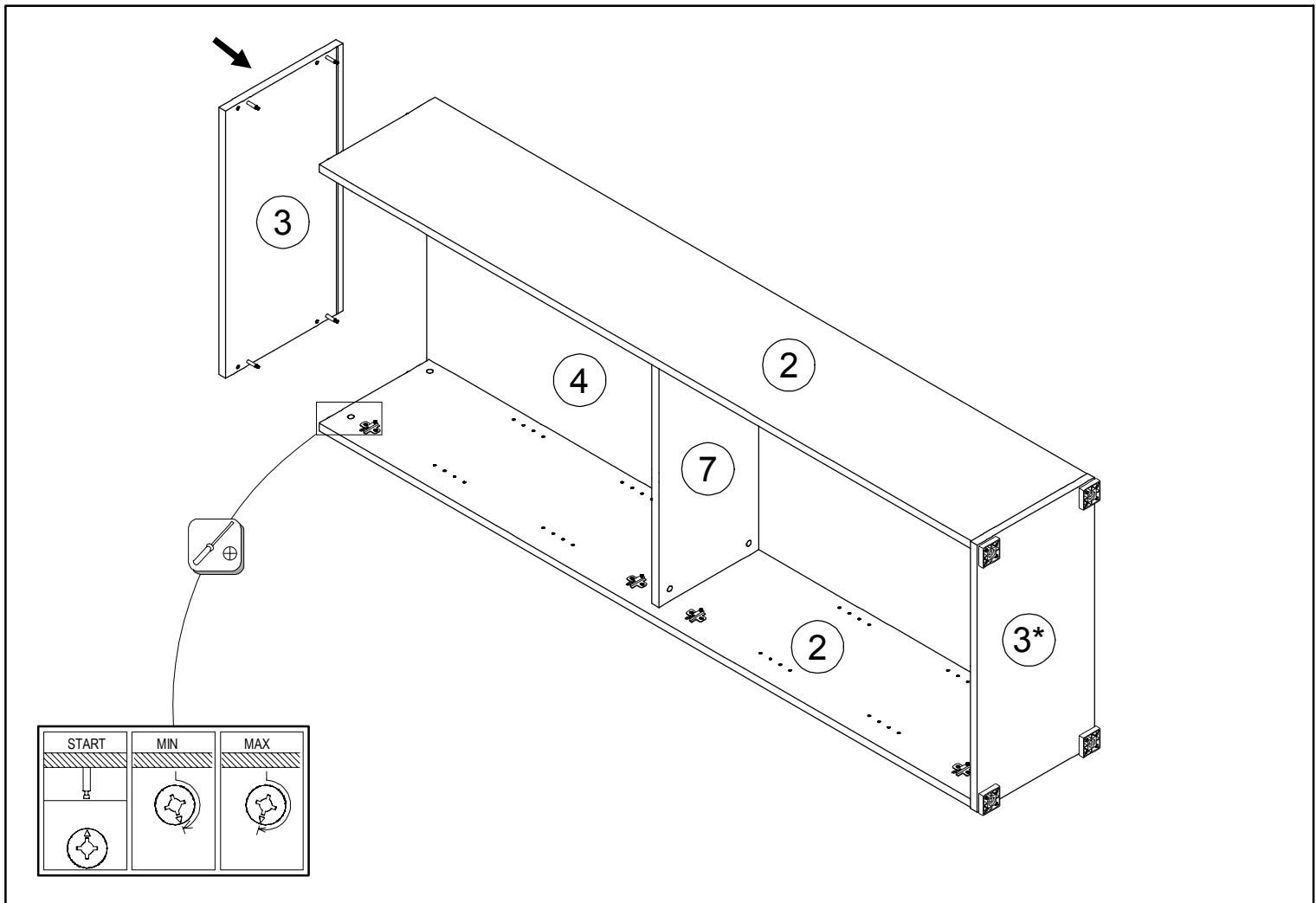
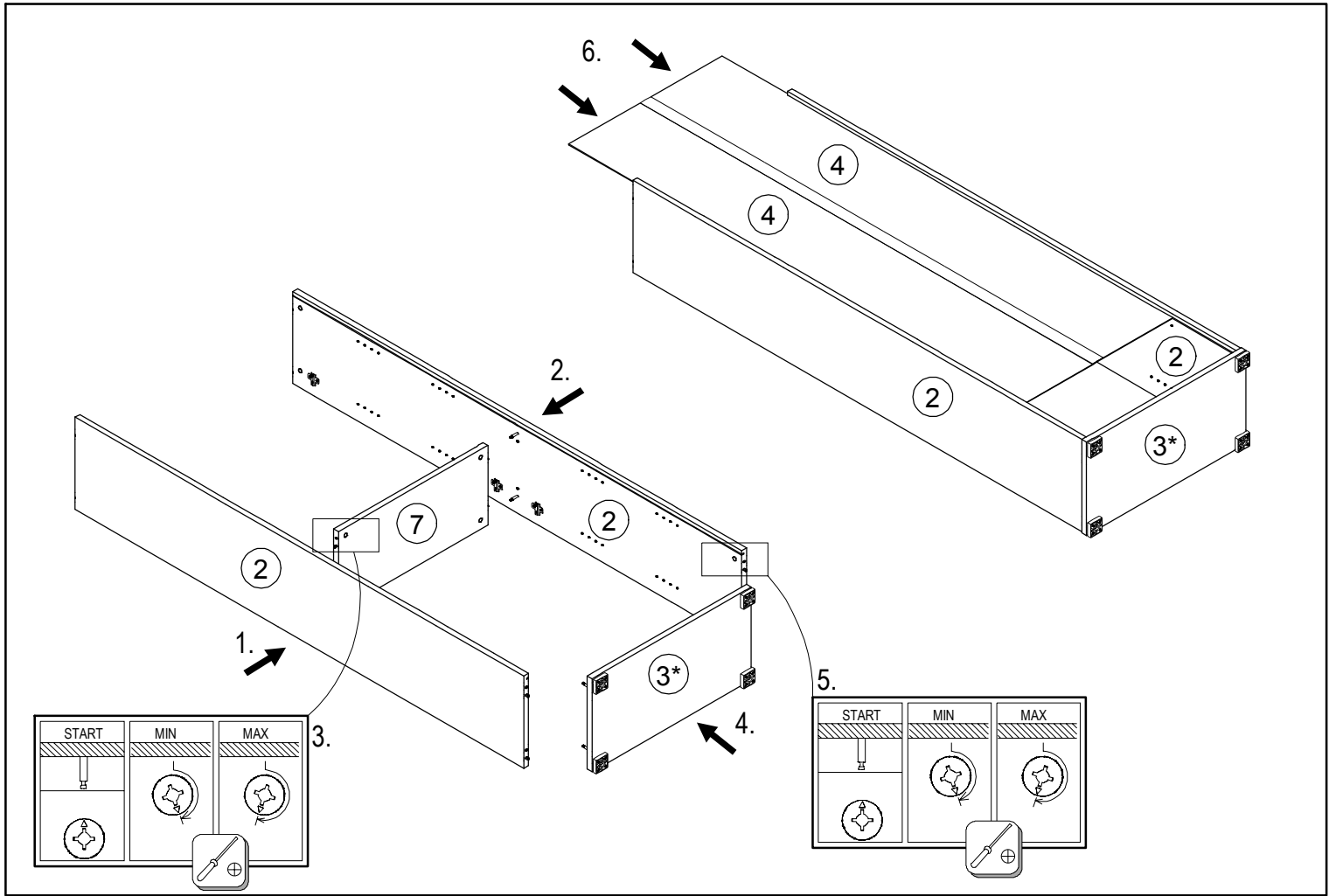
G 16x

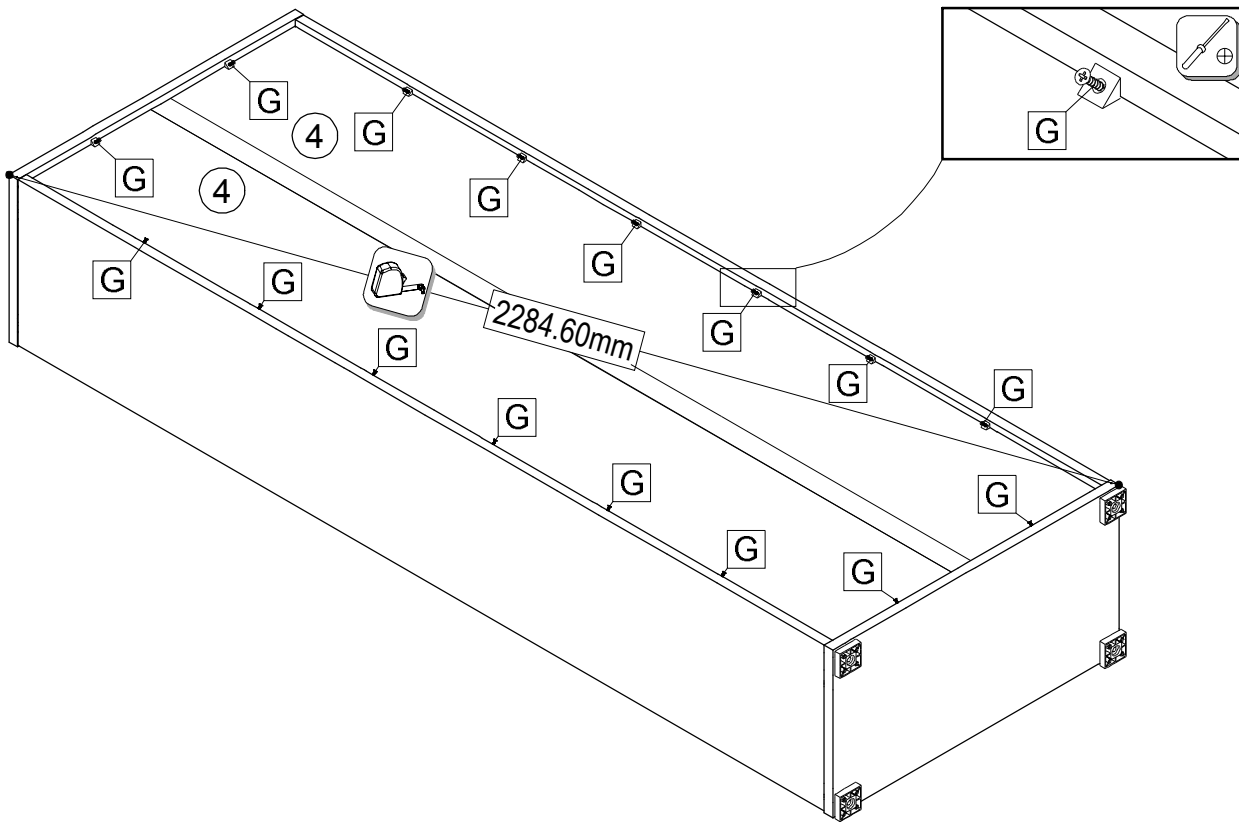

A 2x	K 1x	L 1x	M 1x

1. v = 2137

2. Ø8

3. M

4. K A

5. K L

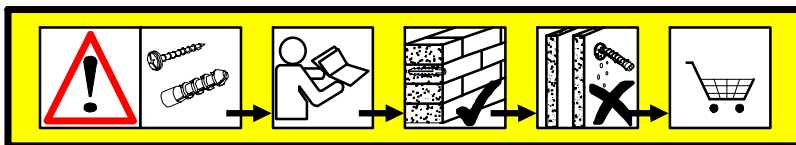
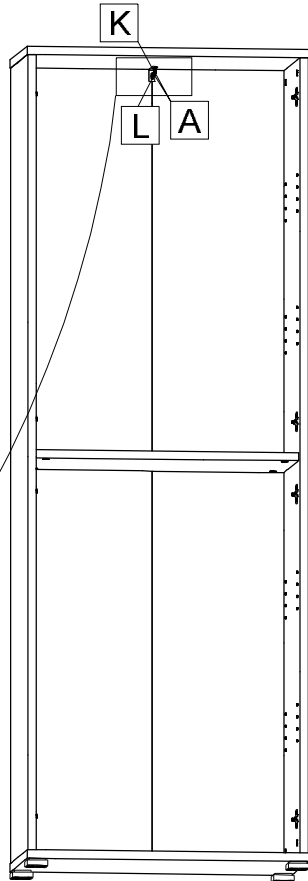

<b>DE</b>	Achtung! Die Wandbeschaffenheit ist vor der Montage unbedingt zu prüfen. Die beigelegten Universaldübel sind ausschließlich nur zur Verwendung für festes Mauerwerk wie Beton/Ziegel. Die Mauerdübel dürfen nicht bei Mauerwerk wie Hohlraumziegel, Leichtbausteinen, Gipskartonplatte oder anderer Rahmenbauweise verwendet werden. Bei diesen Mauerwerken sind gegebenenfalls Spezialdübel zu verwenden! Diese sind in einem Fachgeschäft (Baumarkt) erhältlich. Bei Nichterhaltung wird seitens Produzenten/Händler und Importeur keine Haftung übernommen.	<b>EN</b>	Caution! The wall must be examined before assembly. The included universal wall plugs are only suitable for using in firm masonry such as concrete block or brick. Do not using the wall plugs masonry such as hollow brick, lightweight block, surfaces such as gypsum plasterboard or other framing systems. If applicable, particular wall plugs must be used! These are available at a specialised store (hardware store). In case of non-compliance, the manufacturer/retailer or importer do not assume liability.
<b>SLO</b>	Pozor! Pred montažo preverite stanje stene. Priloženi univerzalni mozniki so izključno samo za uporabo na čvrstem zidu, kot sta beton in opeka. Stenski mozniki se ne smejo uporabljati pri zidu kot so volino opeke, zidaki za lahko gradnjo, mavčne plošče ali druge okvirne gradnje. Pri teh zidovih morate v danih primerih uporabljati posebne moznike. Ti so na voljo v specializiranih trgovinah (trgovinah z gradbenim materialom). Pri upoštevavanju se s strani proizvajalca/trgovca in uvoznika ne prevzame jamstvo.	<b>HR</b>	Pažnja! Prije montaže obvezno provjerite svojstvo zida. Priložene univerzalne tiple namijenjene su isključivo za masivne zidove od betona/opeke. Tiple za masivne zidove ne smiju se koristiti za zidove kao npr. šupljina opeka laki sastavni elementi, gips-kartonske ploče ili drugi modularni načini gradnje. Za te zidove potrebne su eventualno specijalne tiple! Iste su dostupne u specializiranim trgovinama građevinskim materijalom. U slučaju nepridržavanja prethodno navedenih napomena, proizvođač/trgovac i uvoznik ne preuzimaju odgovornost!
<b>SK</b>	Upozornenie! Pevnosť steny sa musí pred montážou bezpodmienečne skontrolovať. Univerzálne hmoždenky, ktoré sú obsiahnuté v balení, používajte jedine pre pevné múry ako je betón/tehla. Hmoždenky sa nesmú používať v prípade ľahkého stavebného múru, dutá tehla, u sádkartónových dosiek alebo iných konštrukcií rámu. U týchto múrov je nutné použiť špeciálne hmoždenky! Tieto je možné dostať v špeciálnych predajniach so stavebným materiálom (stavebniny). Pri nedodržaní pokynov nepreberajú výrobcovia/predajci a dodávateľa zodpovednosť za vzniknuté škody.	<b>CZ</b>	Upozornění! Před montáží je nutné zkontrolovat stav stěny. Priložené univerzální hmoždinky jsou určeny pouze k použití pro pevné zdivo jako beton/cihly. Hmoždinky do zdi se nesmí používat u dutinová cihla, zdiva jako pórovitý stavební kámen, sádkartónová deska nebo jiný měkký materiál. U těchto zdív jsou nutné použít speciální hmoždinky! Jsou k dostání v speciálních prodejních se stavebním materiálem. Při nedodržení těchto pokynů výrobce/prodejce a dovvoze neručí za způsobené škody.
<b>HU</b>	Vigyázat! Szerelés előtt a falülelet feltétlenül vizsgálja meg. A mellékelt univerzális tipkizárólag stabil falazathoz használható mint például beton/tégla. A fal tipkij nem használható könnyű építőkövekhez, üreg tégla, gipszkarton lapokhoz vagy más fűvázás építményekhez. Ezekhez a falüleletekhez csak speciális tipk használhatóak, melyek szaküzletekben (barkácsruházakban) beszerezhetők. Fontos figyelmen kívül hagyása esetén a gyártó/kereskedő vagy forgalmazó nem vállal felelősséget.	<b>S</b>	Obs! Väggens sammansättning ska absolut kontrolleras innan montering. De bifogade pluggarna får endast användas för stabila och fasta väggar, som t.ex. betong/tegel. De får absolut inte användas för kavlet tegel, väggar ur lösligt gipskiv eller dylikt. För dessa väggar måste det användas speciella pluggar, som finns att köpa i specialiserad handel (byggmarknad). Varken tillverkare, handlare eller importör övertar ansvar, om dessa anvisningar inte följs.



E	16x
---	-----

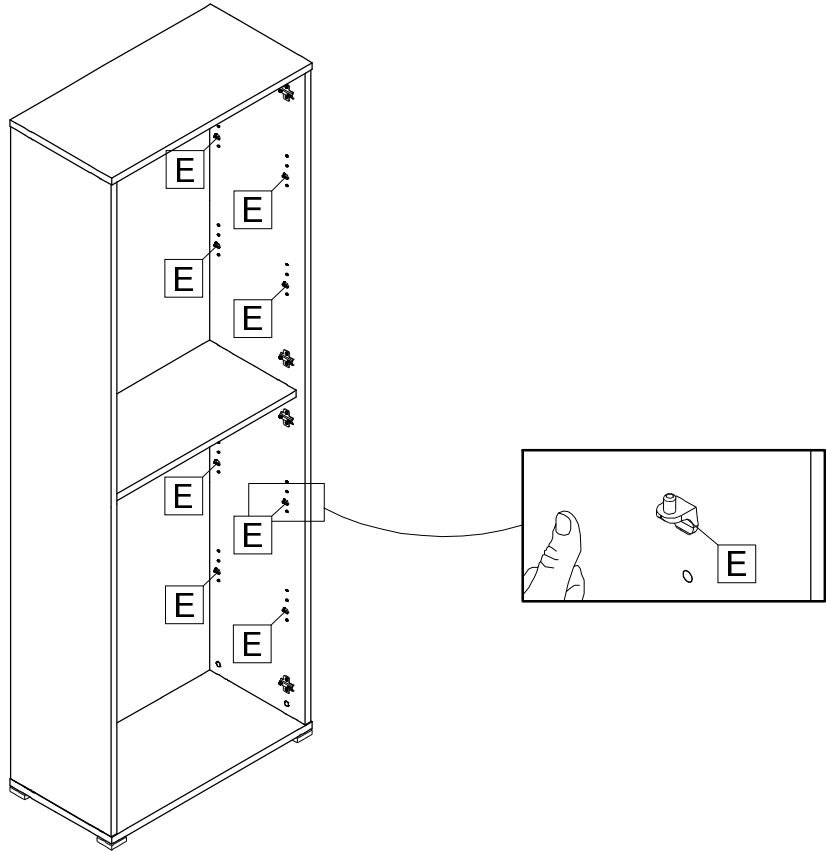

H	12x
---	-----

