

SZAFA 2D - 1986x600x320

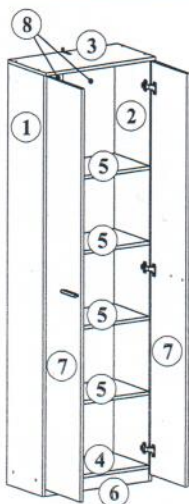

| | | |
|-----------------|----------------------------|------------------|
| Pr X6 | Z1 X6 | Gw X44 |
| Kl X1 | Us1 X14 Us1,5x16 | Sl X4 |
| Uk X2 | Up4 X4 Up3,5x30 | P2 X16 |
| Kn X8 | Za2 X4 | Ko X2 |
| L X1 | Wk X1 | |

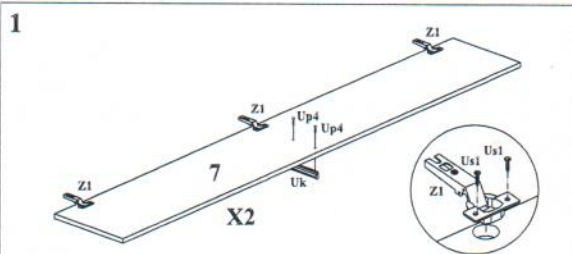
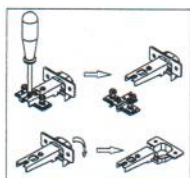

1/2

2

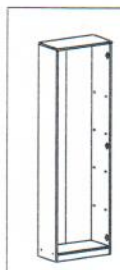
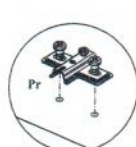
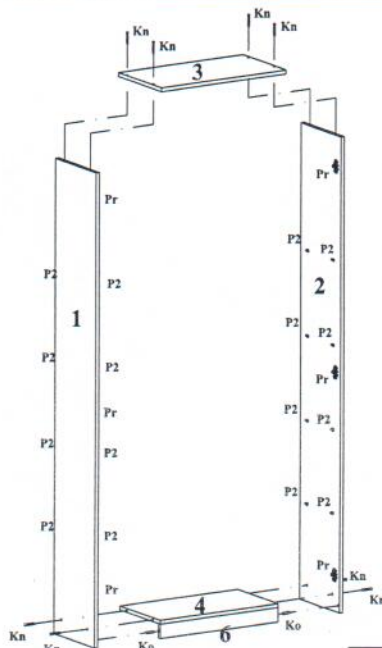

3

X = Y

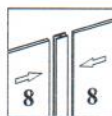
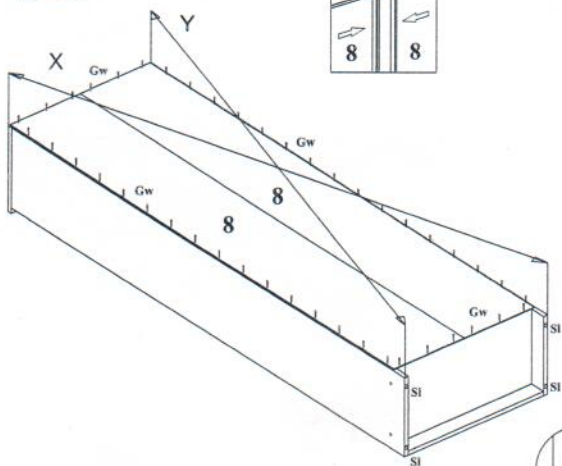

SZAFA 2D

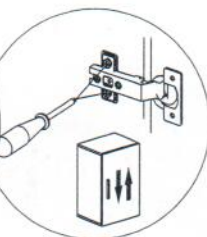
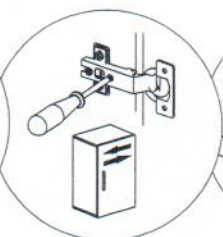
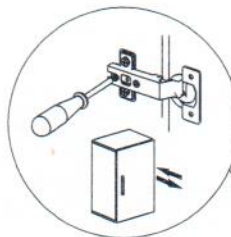

4

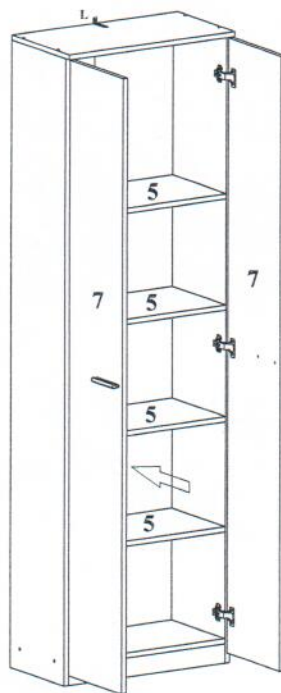

2/2