

SK NÁVOD NA MONTÁŽ
 CZ MONTÁŽNÍ NÁVOD
 HU SZERELÉSI UTASÍTÁS
 DE MONTAGEANLEITUNG

PATENT NEW

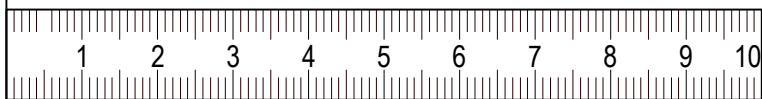

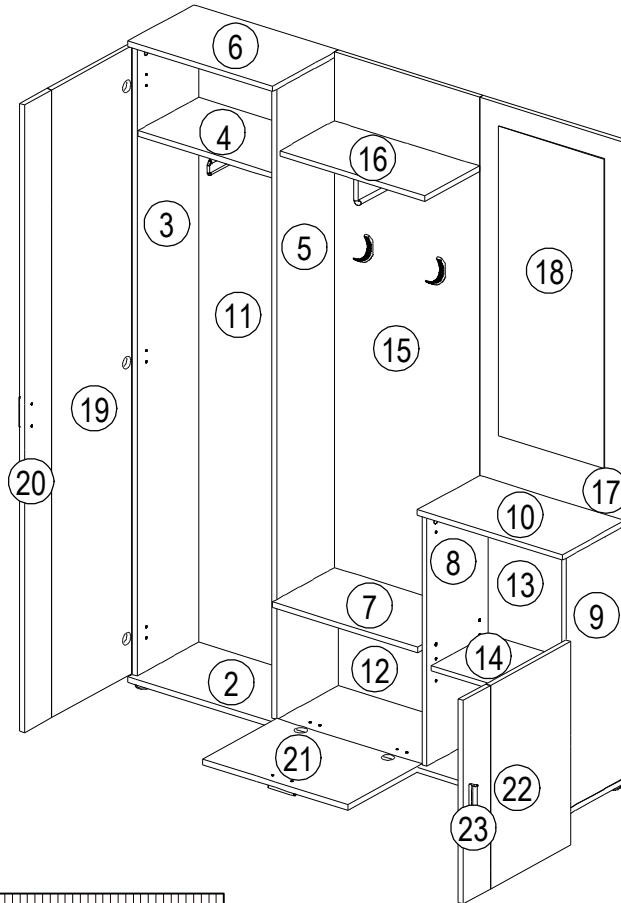
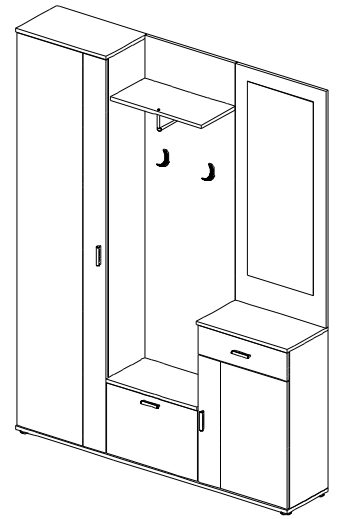
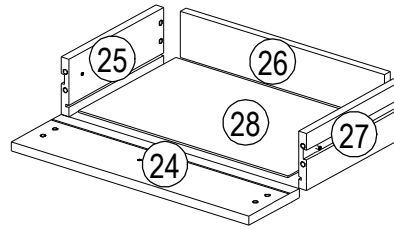

	1440	mm
	1880	
	290	

10553	②	1440*290*16	1x	1/2
10554	③	1833*270*16	1x	1/2
10555	④	446*268*16	1x	1/2
10556	⑤	1833*270*16	1x	1/2
10557	⑥	480*290*16	1x	1/2
10558	⑦	482*290*16	1x	1/2
10559	⑧	733*270*16	1x	1/2
10560	⑨	733*270*16	1x	1/2
10561	⑩	480*290*16	1x	1/2
10562	⑪	1858*467*2,5	1x	2/2
10563	⑫	358*498*2,5	1x	2/2
10564	⑬	758*467*2,5	1x	2/2
10565	⑭	446*250*16	1x	1/2
10566	⑮	1500*480*16	1x	2/2
10567	⑯	481*240*16	1x	2/2
10568	⑰	1100*480*16	1x	2/2
10569	⑱	900*350*3	1x	2/2
10570	⑲	1826*352*16	1x	2/2
10571	⑳	1826*120*16	1x	2/2
10572	㉑	327*482*16	1x	2/2
10573	㉒	592*352*16	1x	2/2
10574	㉓	592*120*16	1x	2/2
10575	㉔	472*132*16	1x	2/2
10579	㉕	250*100*16	1x	1/2
10576	㉖	406*80*16	1x	1/2
10577	㉗	250*100*16	1x	1/2
10578	㉘	256*416*2,5	1x	2/2

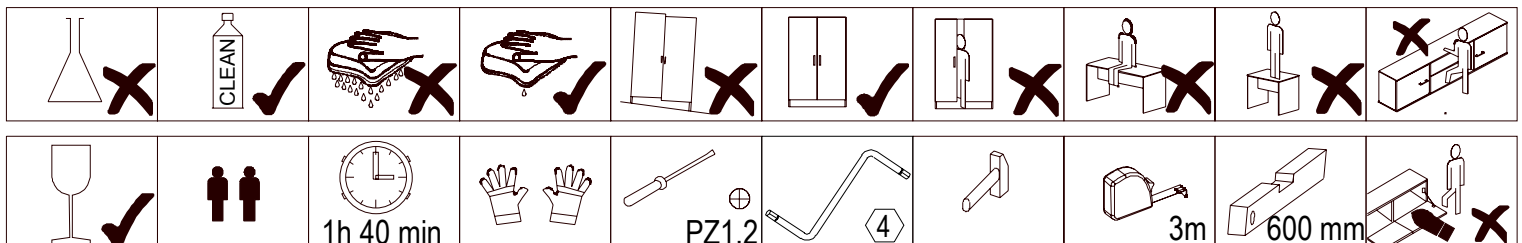



22250,00 Ø4x25	21102,00 Ø1,2x20	31103,00 	32314,01 	22501,02 M4x20	36002,07 	36002,07 	27001,00 Ø8x40	70013,01 	70021,01
A 6x	B 75x	C 1x	D 4x	E 14x	F 5x	F1 5x	G 11x	H 12x	J 12x
22243,00 Ø3,5x15	27000,00 Ø8x30	70889,00 	22300,00 Ø7x50	22502,00 M4x12	22705,00 Ø6,3x8	22244,01 Ø3,5x16	35102,00 	33030,00 	35101,01
K 26x	L 40x	M 1x	N 17x	P 2x	Q 4x	R 10x	S 1x	T 1x	U 4x
9290,00 	30080,00 Ø44x15	31025,00 	31026,00 	36001,01 	36001,01 	31003,02 			
V 3x	W 6x	X 1x	Y 2x	Z 2x	Z1 2x	Z2 1x			



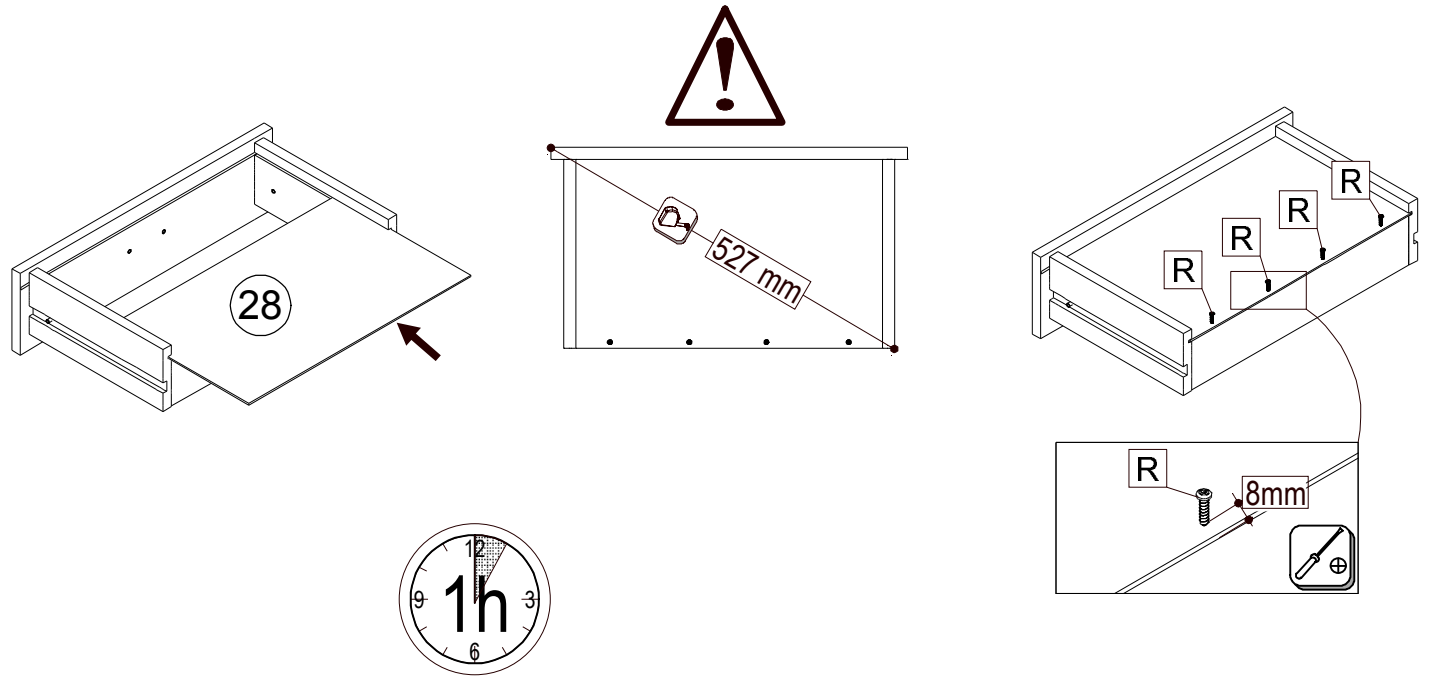
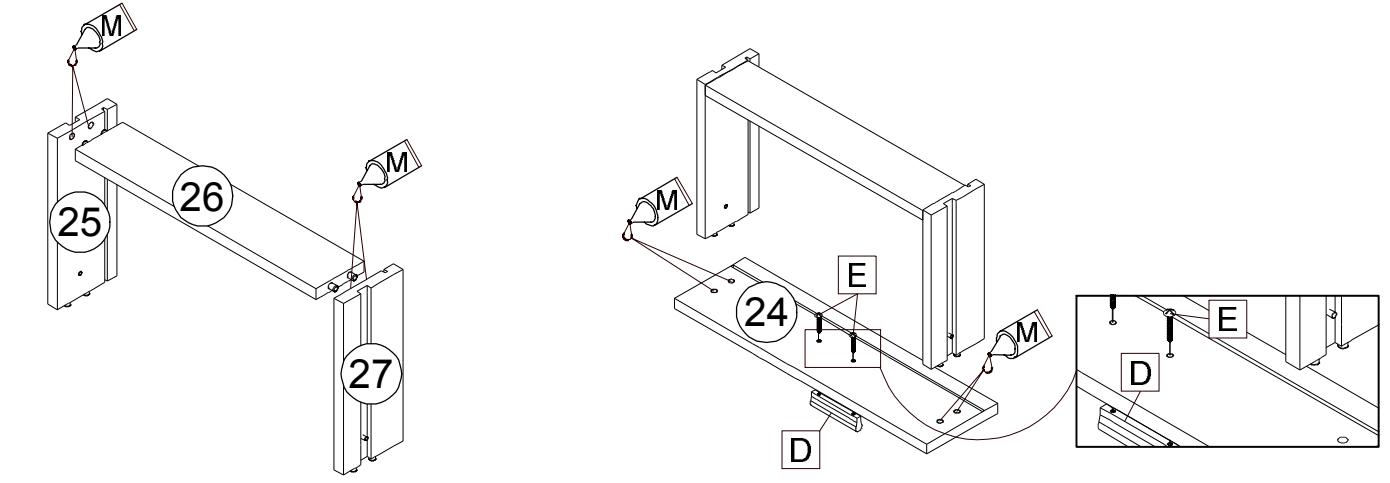
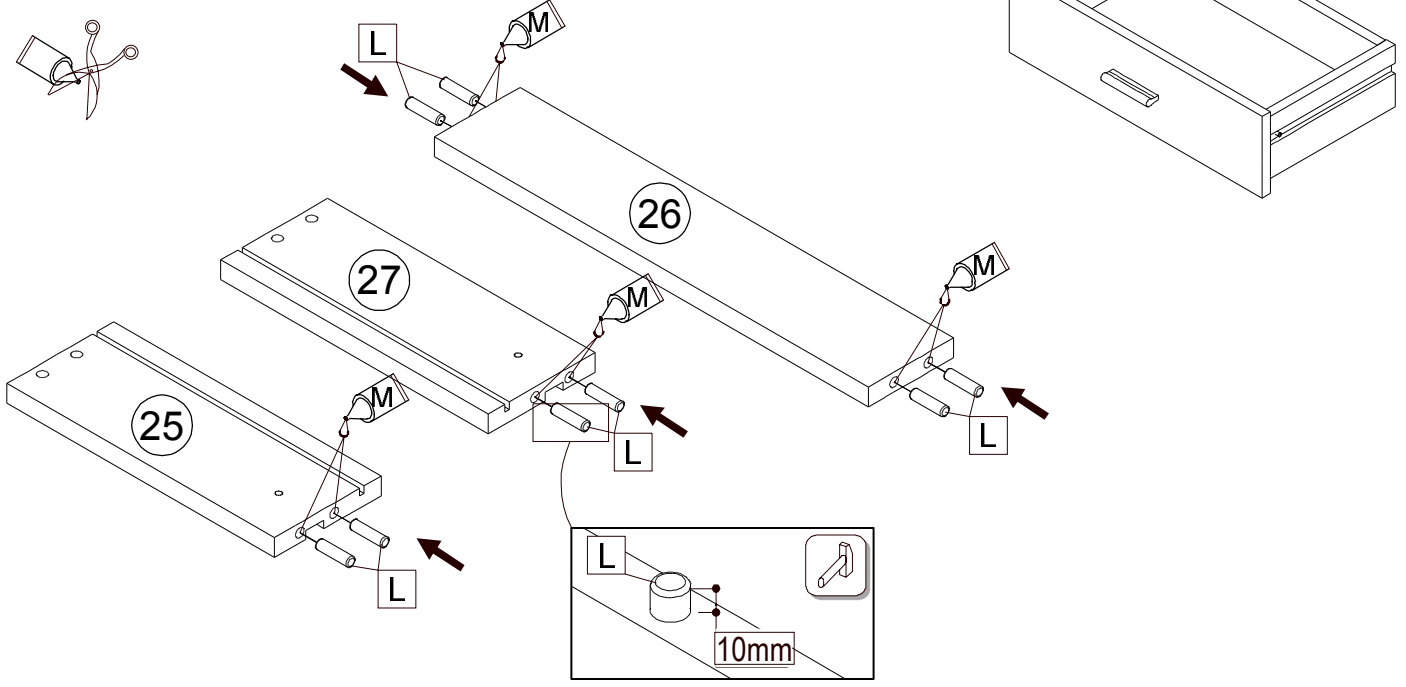





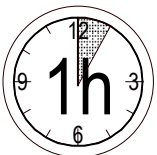
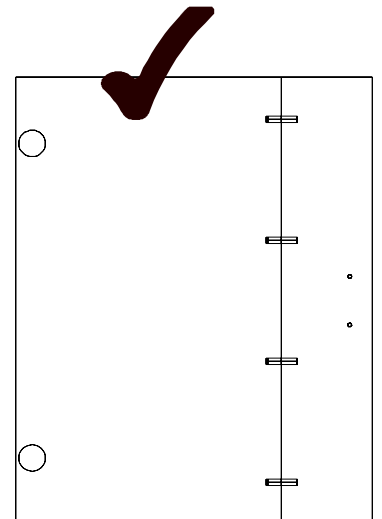
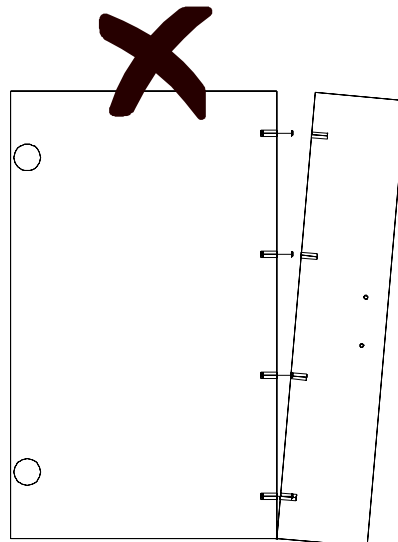
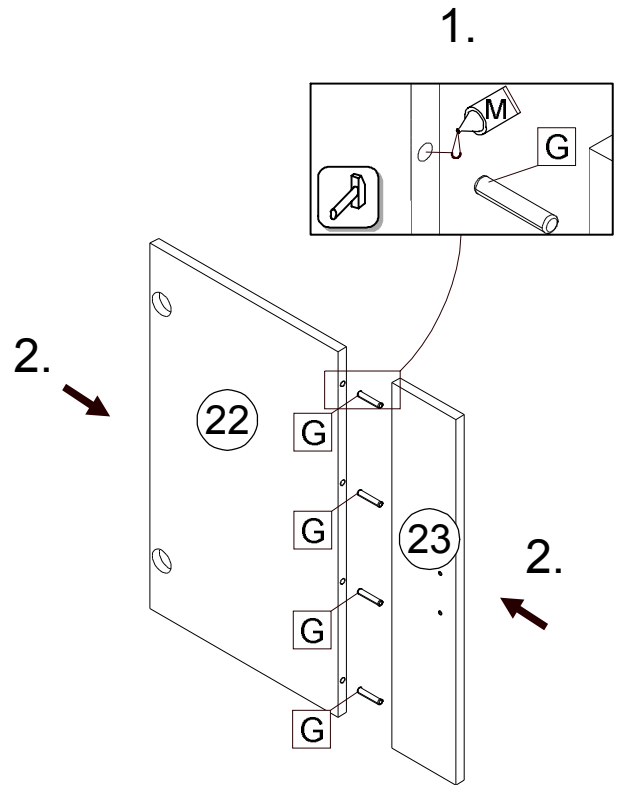
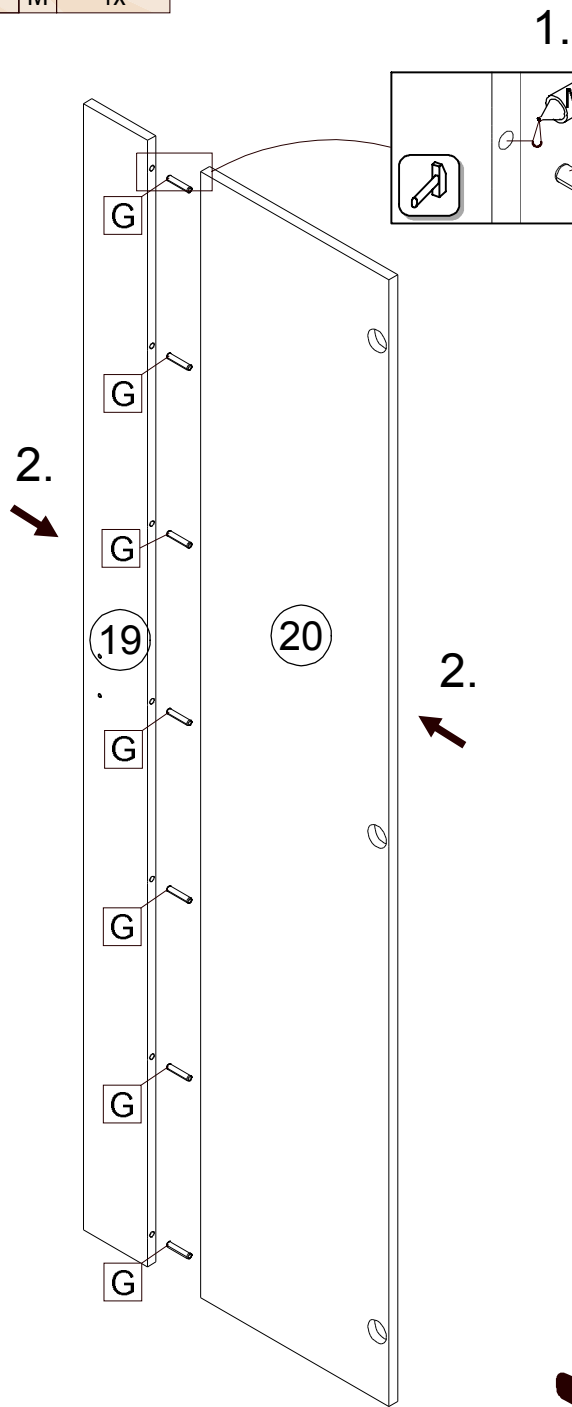





				
D 1x	E 2x	L 8x	M 1x	R 4x







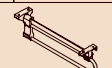

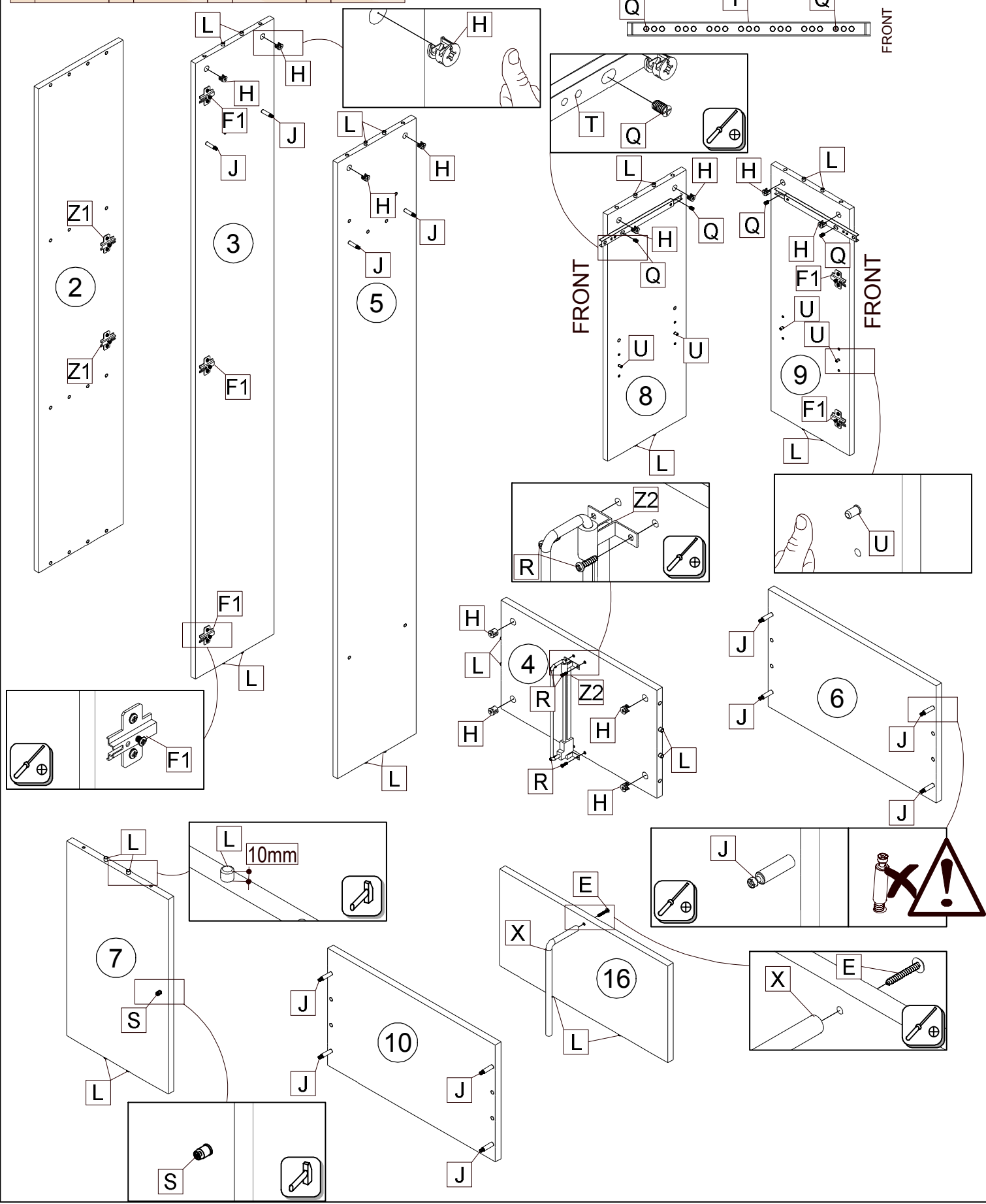
	
Ø8x40	
G 11x	M 1x







 M4x20	 F1	 H	 J	 Ø8x30	 Ø6,3x8	 Ø3,5x16	 S	 T
E 1x	F1 5x	H 12x	J 12x	L 26x	Q 4x	R 4x	S 1x	T 1x
 U	 X	 Z1	 Z2					
U 4x	X 1x	Z1 2x	Z2 1x					

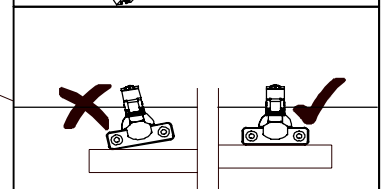
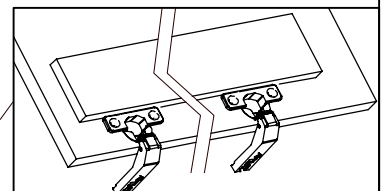
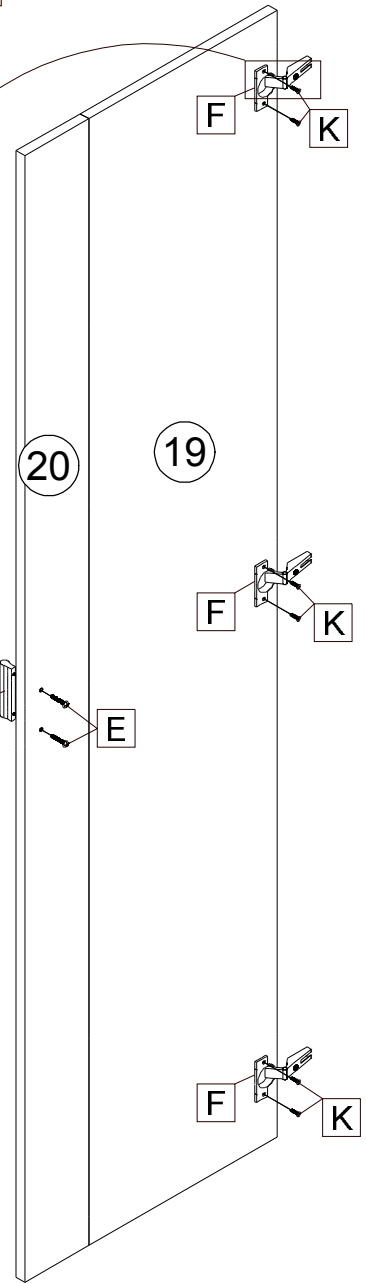
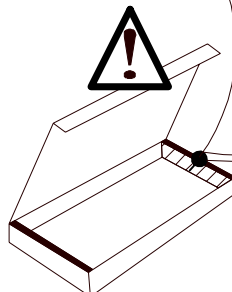
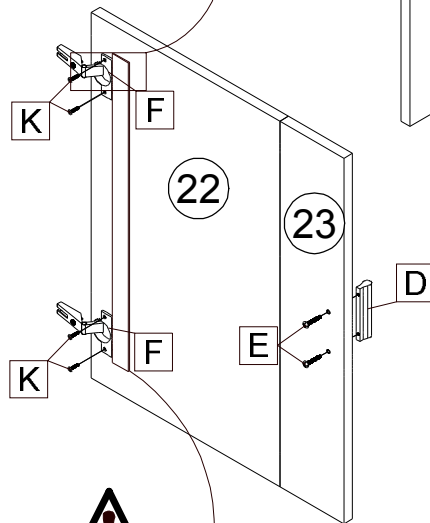
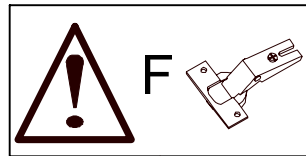
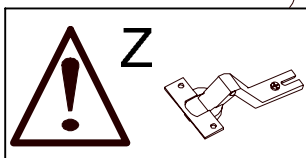
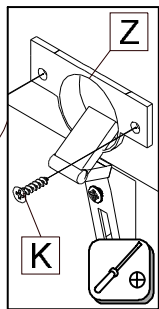
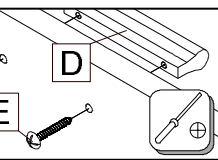
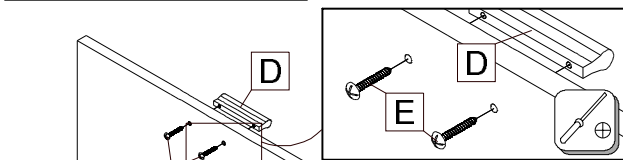
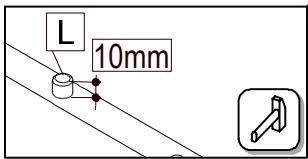
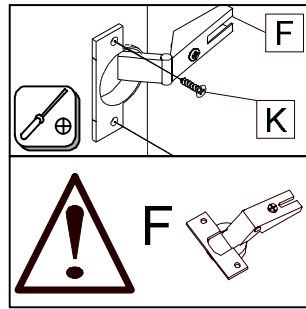
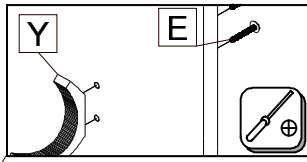
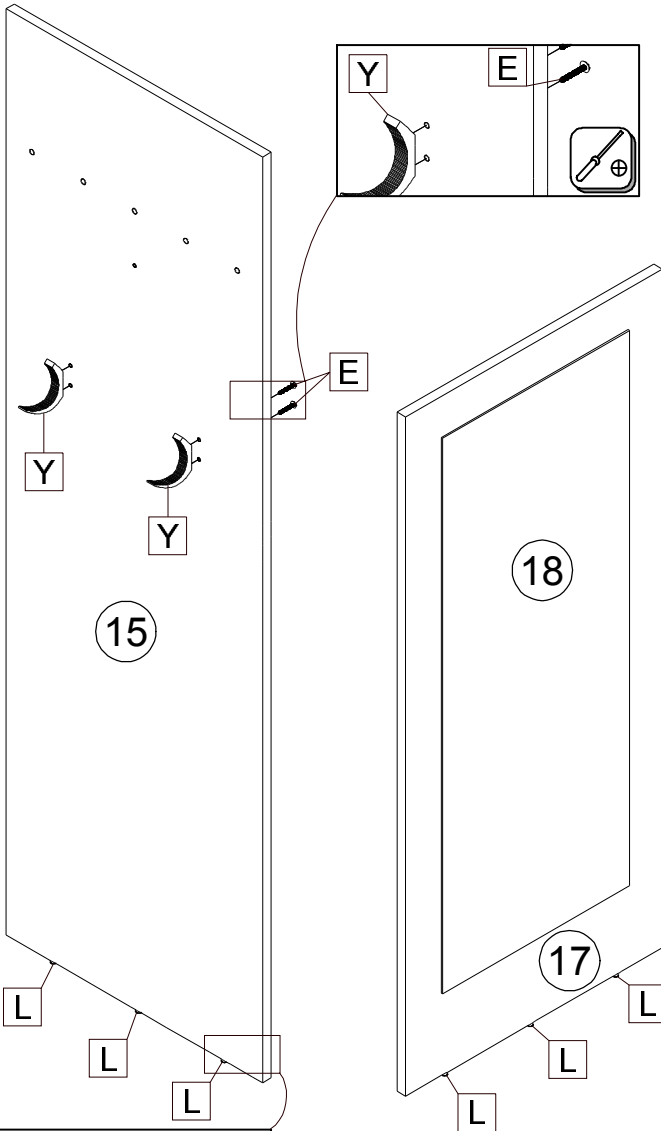

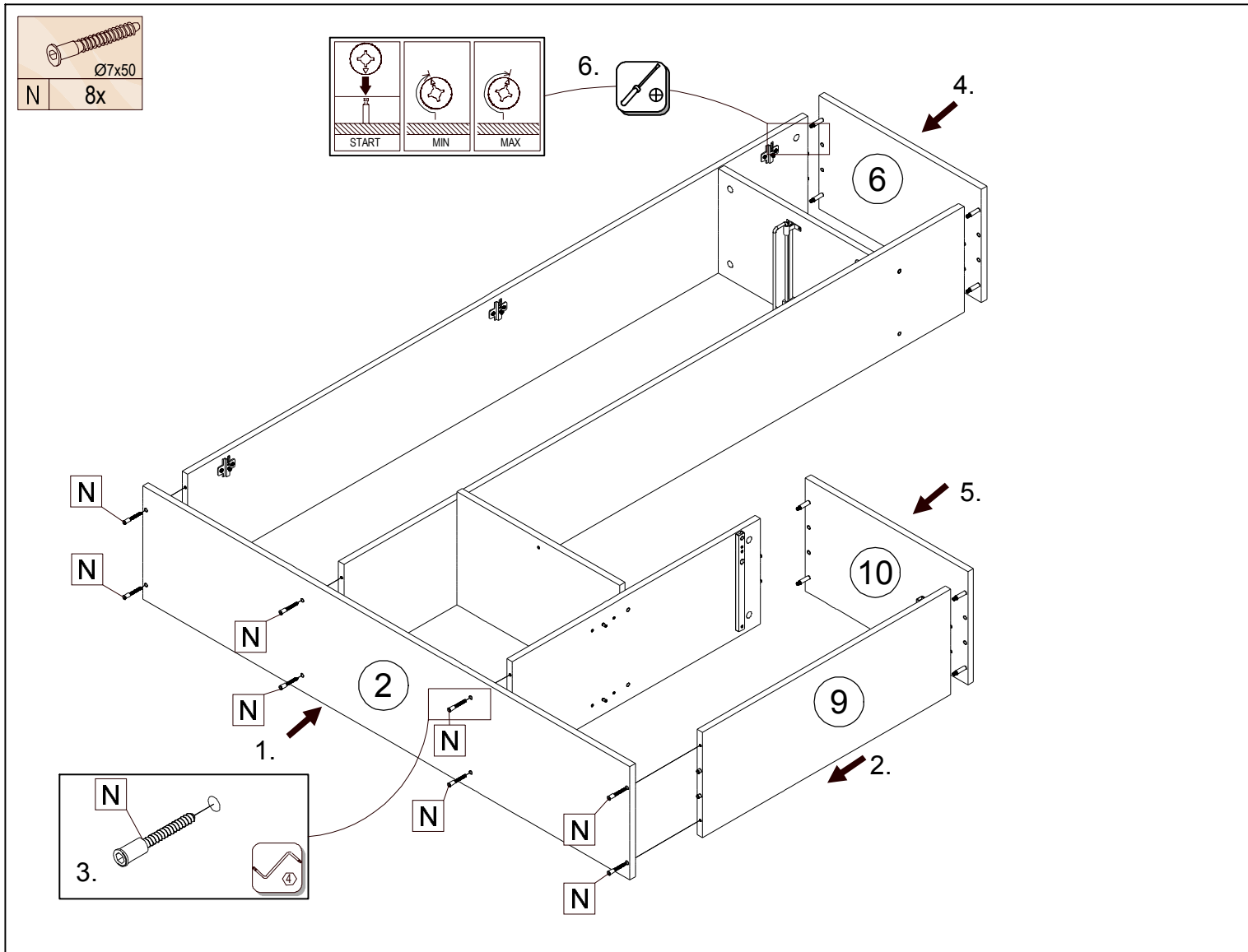
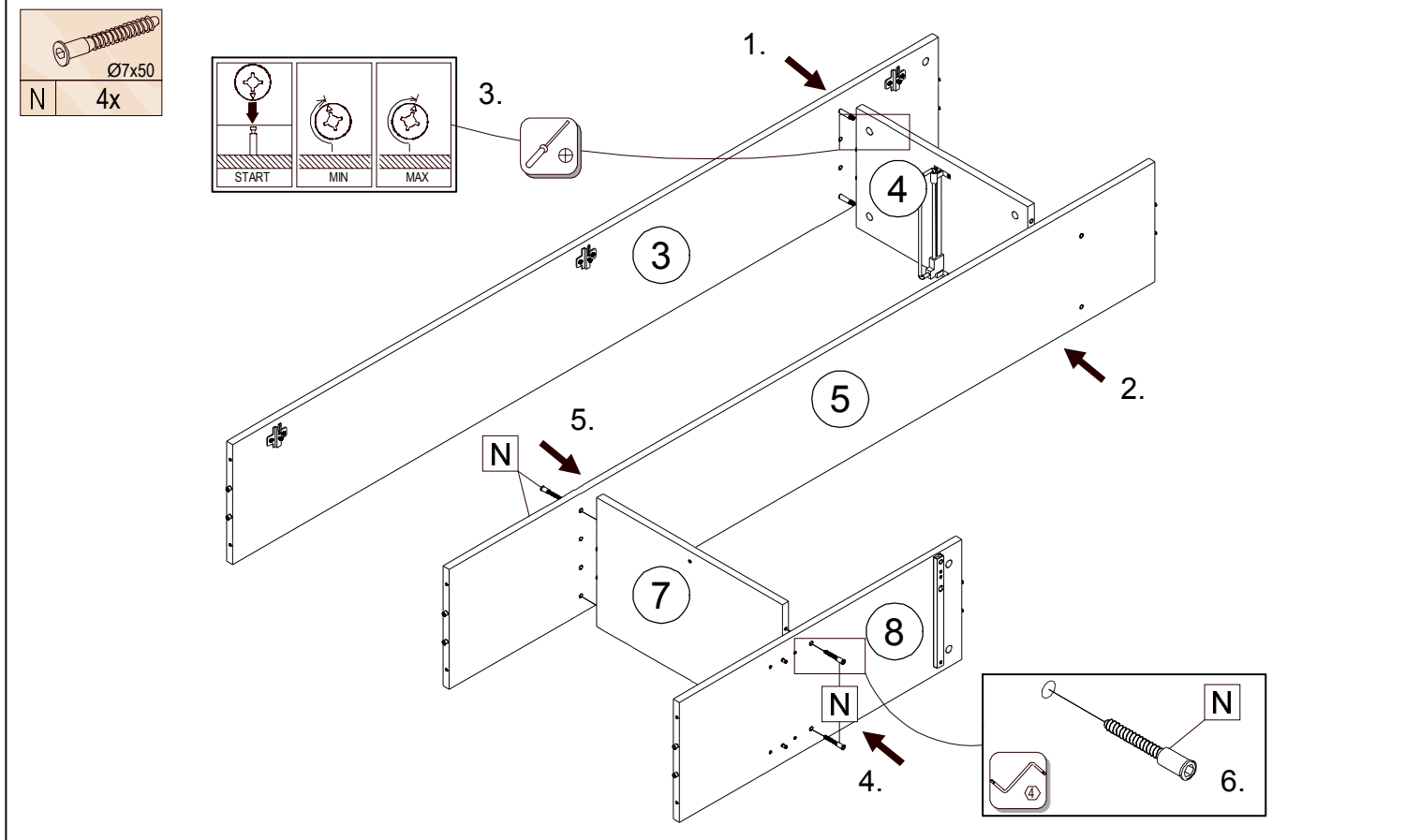

						
D 3x	E 10x	F 5x	K 14x	L 6x	Y 2x	Z 2x

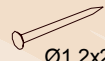



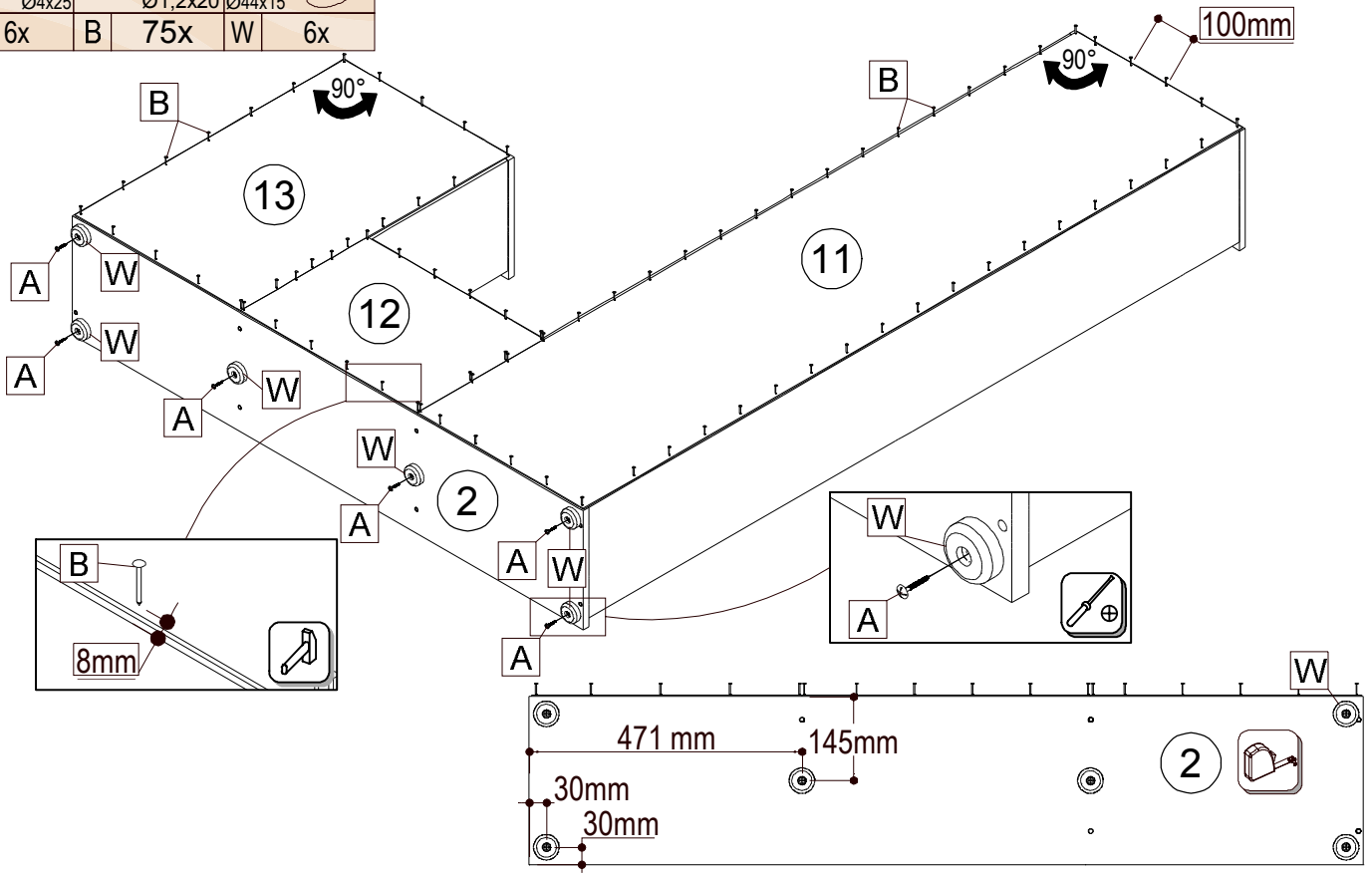

		
Ø4x25	Ø1,2x20	Ø44x15
A 6x	B 75x	W 6x



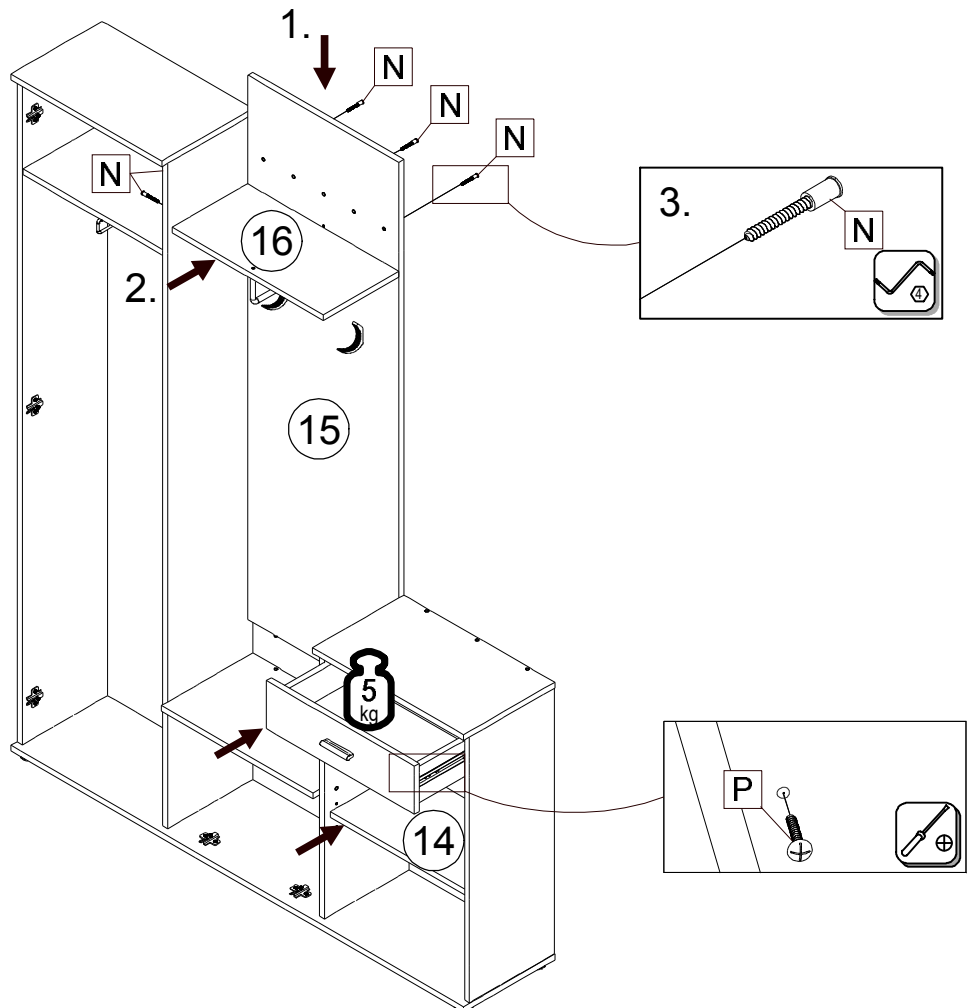

	
Ø7x50	M4x12
N 5x	P 2x

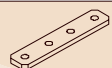

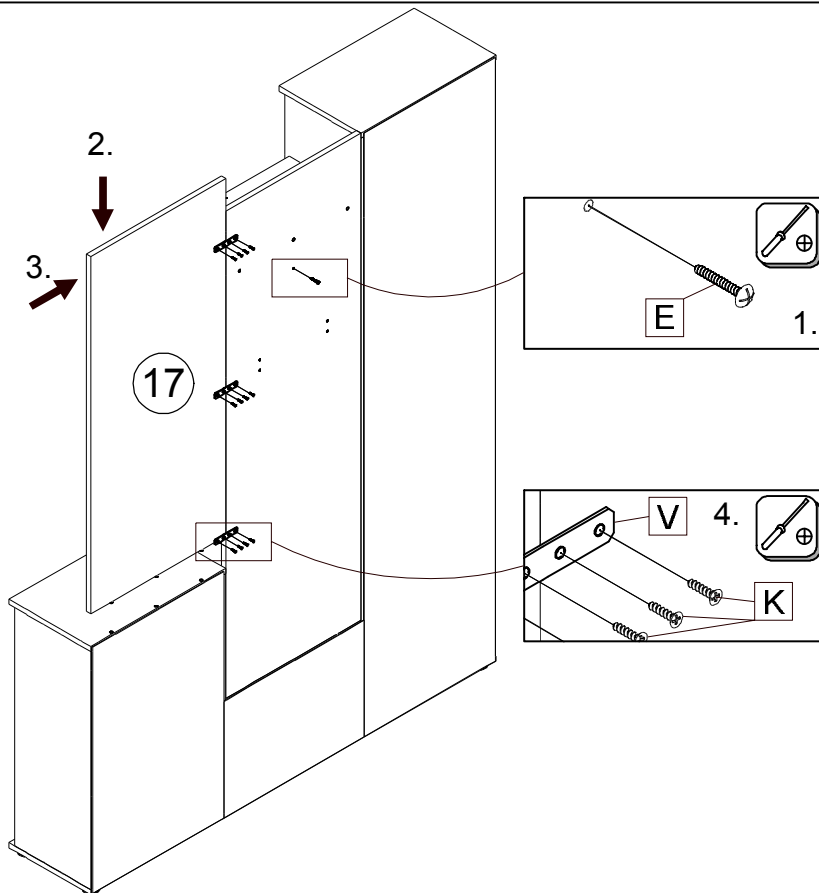
	M4x20		Ø3,5x15	
E	1x	K	12x	V
				3x

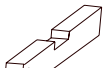

	1x		Ø3,5x16		600 mm
C	1x	R	2x		

