

ARTID TYP2



ax11



bx3



cx3



dx2

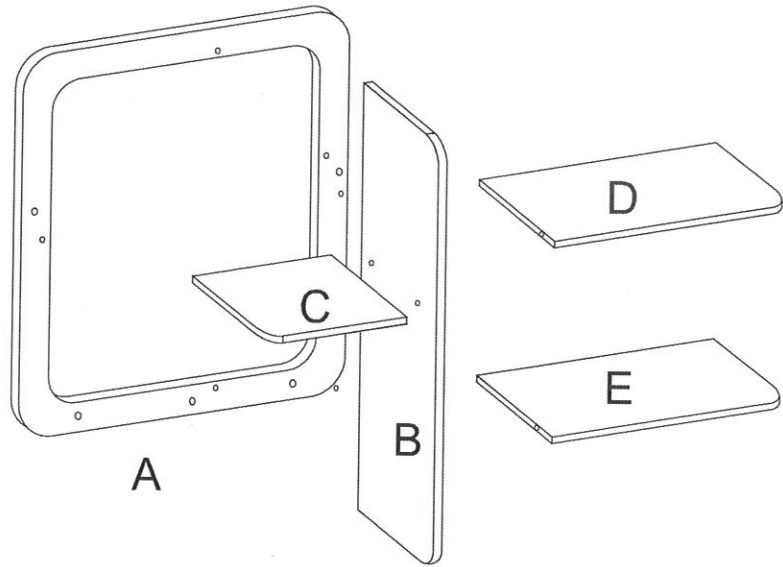

1

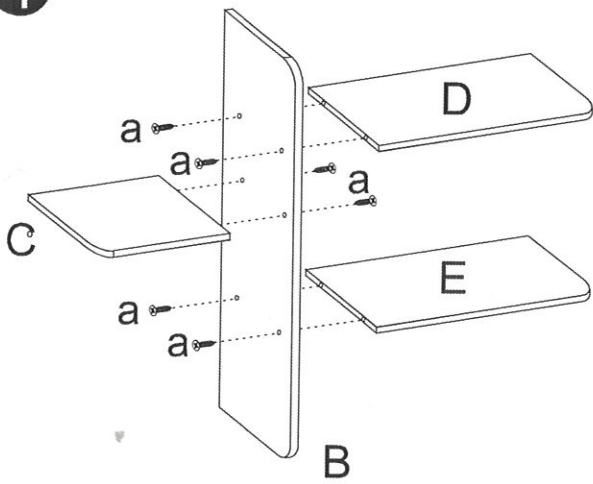

2

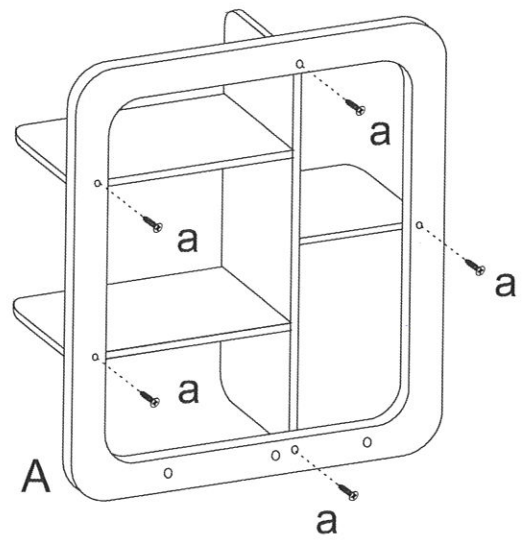

3

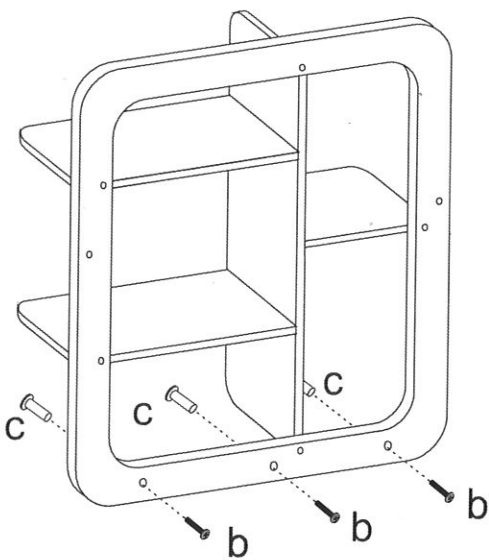

4

