

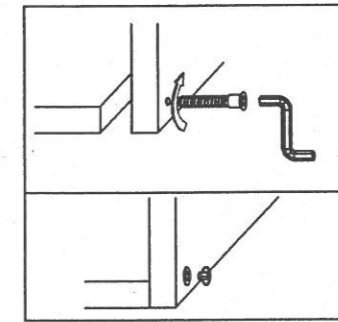

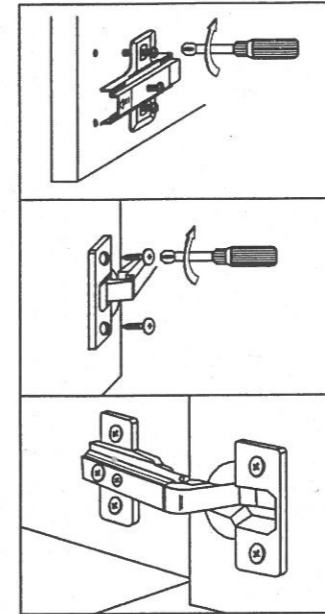

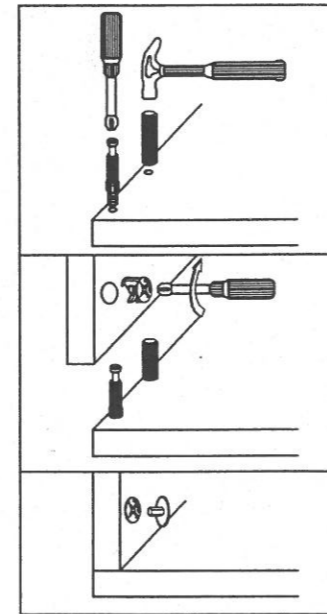

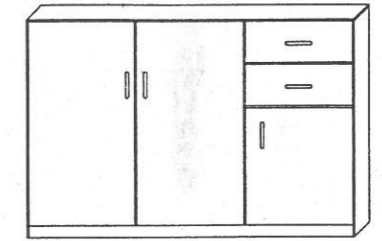















SZAFKA - K1-3D-2S



						 Z9	 P9	 KLEJ	 PP
						2	2	1	8
 KF50	 Z2	 KZ	 K30	 T1	 M1	 Z1	 SN	 E5x13	
6	6	1	25	6	6	6	4	8	
 ZK	 KP	 W3,5x16	 G2	 U1	 W4x27	 ZP	 PZ	 W4x16	
8	4	8	60	5	10	4	4	20	

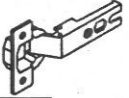