

SK NÁVOD NA MONTÁŽ
 CZ MONTÁŽNÍ NÁVOD
 HU SZERELÉSI UTASÍTÁS
 DE MONTAGEANLEITUNG

INVITA TYP 5

	900	mm
	2000	
	600	

11603	②	2000*580*16	1x	1/3
11583	③	868*579*16	3x	2/3
11585	④	868*80*16	2x	2/3
11604	⑤	2000*580*16	1x	1/3
11620	⑥	1914*446*2,5	2x	1/3
11605	⑦	1498*438*16	1x	3/3
11606	⑧	1498*438*16	1x	3/3
11607	⑨	880*205*16	2x	2/3
11660	⑩	430*120*16	2x	2/3
11608	⑪	828*100*16	2x	2/3
11661	⑫	430*120*16	2x	2/3
11609	⑬	436*838*2,5	2x	2/3
11674	⑭	868*574*16	2x	1/3
11674	⑭	868*574*16	1x	2/3

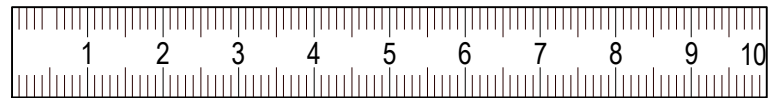
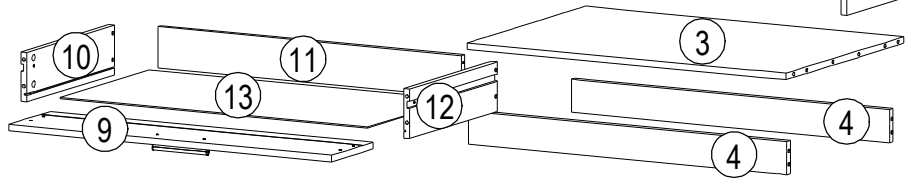
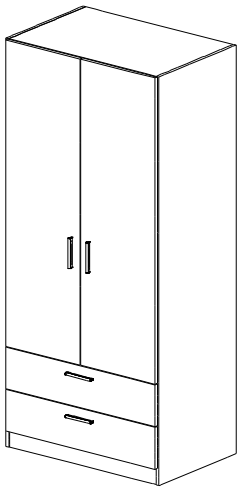
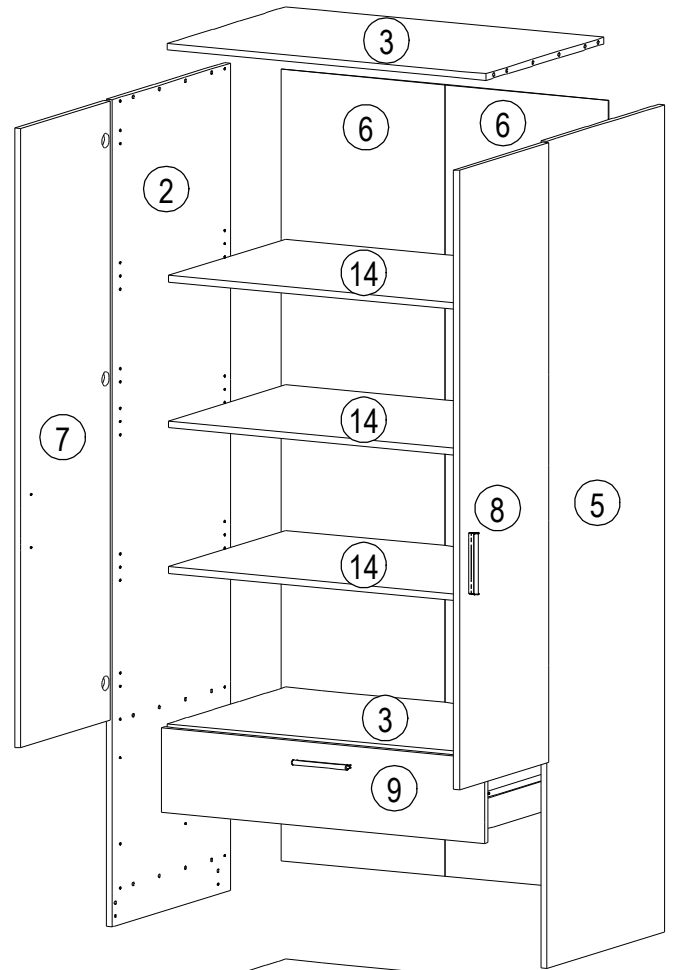

22243,00 Ø3,5x15	27000,00 Ø8x30	35101,01 	70013,01 	70021,01 	30090,00 	21102,00 Ø1,2x20	31103,00 	22244,01 Ø3,5x16	24103,00 Ø8
A 12x	B 28x	C 12x	D 24x	E 24x	F 8x	G 75x	H 1x	J 16x	K 1x
22213,00 Ø4x70		32030,00 	36013,02 	36013,02 	22430,00 Ø4x25	22300,00 Ø7x50	22502,00 M4x12	22705,00 Ø6,3x8	33018,00
L 1x	M 12x	N 4x	P 6x	Q 6x	R 8x	S 8x	T 4x	U 8x	V 2x

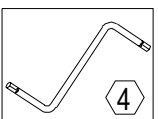

		150 min		PZ2		3m	600 mm		



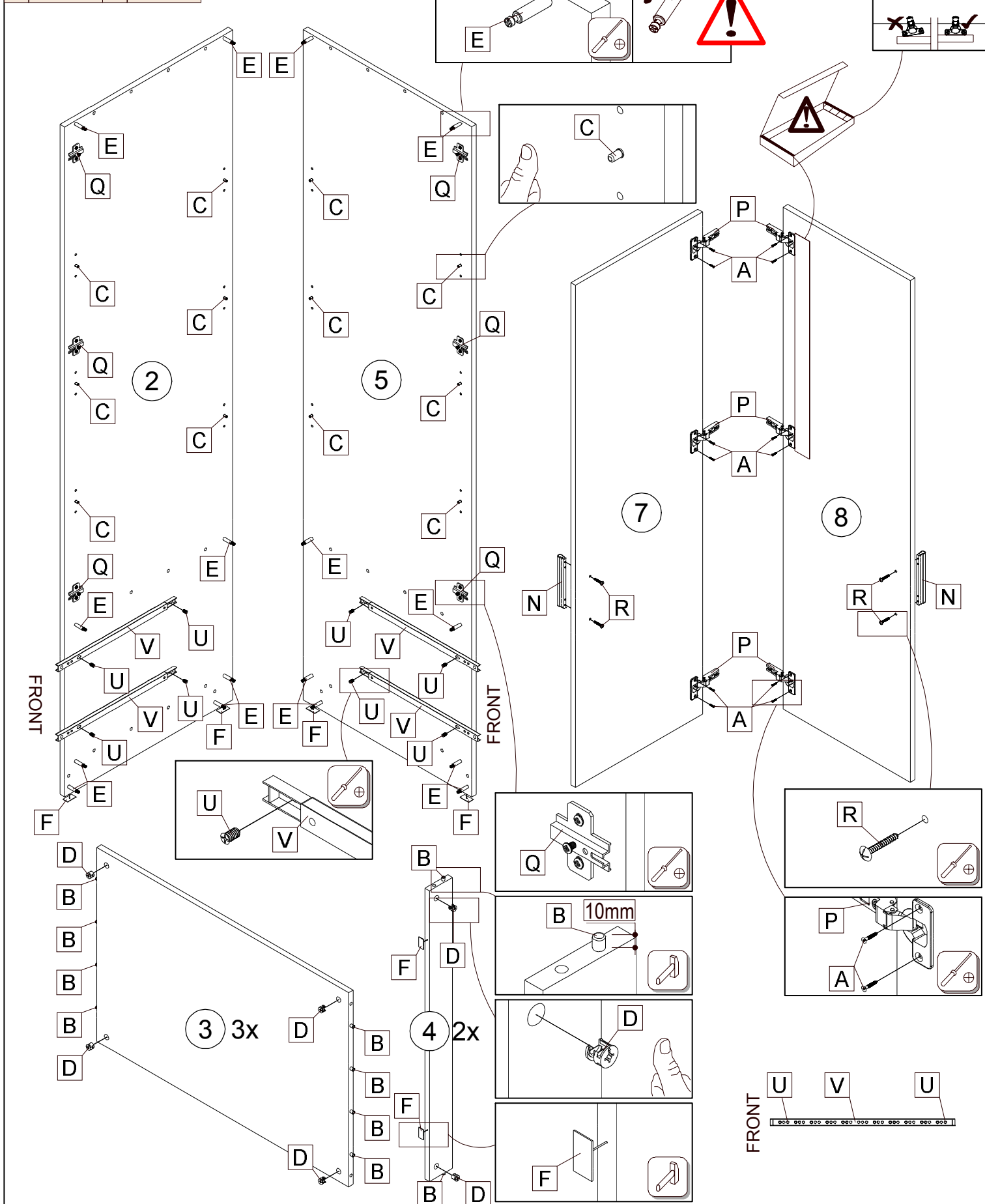

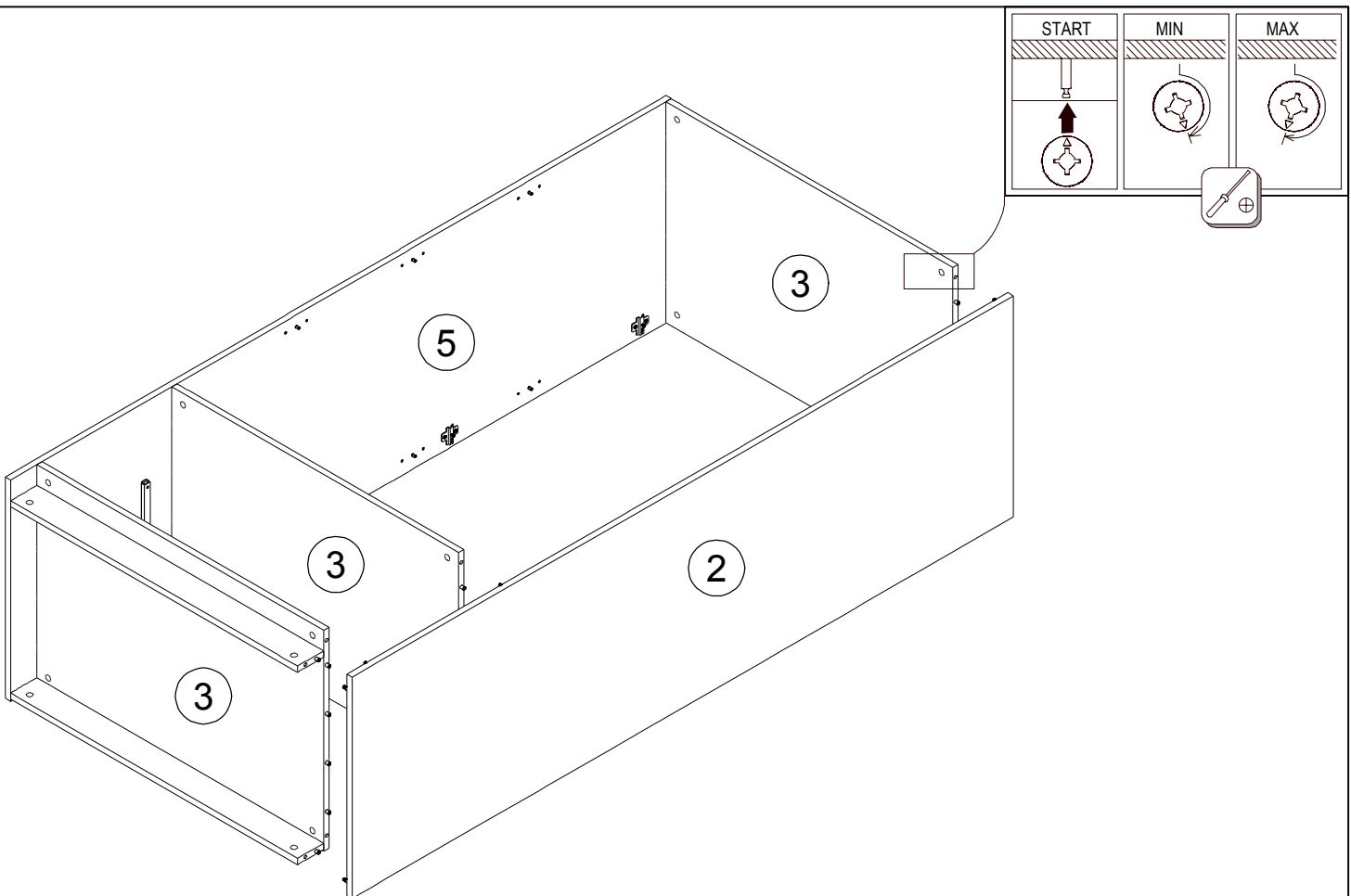
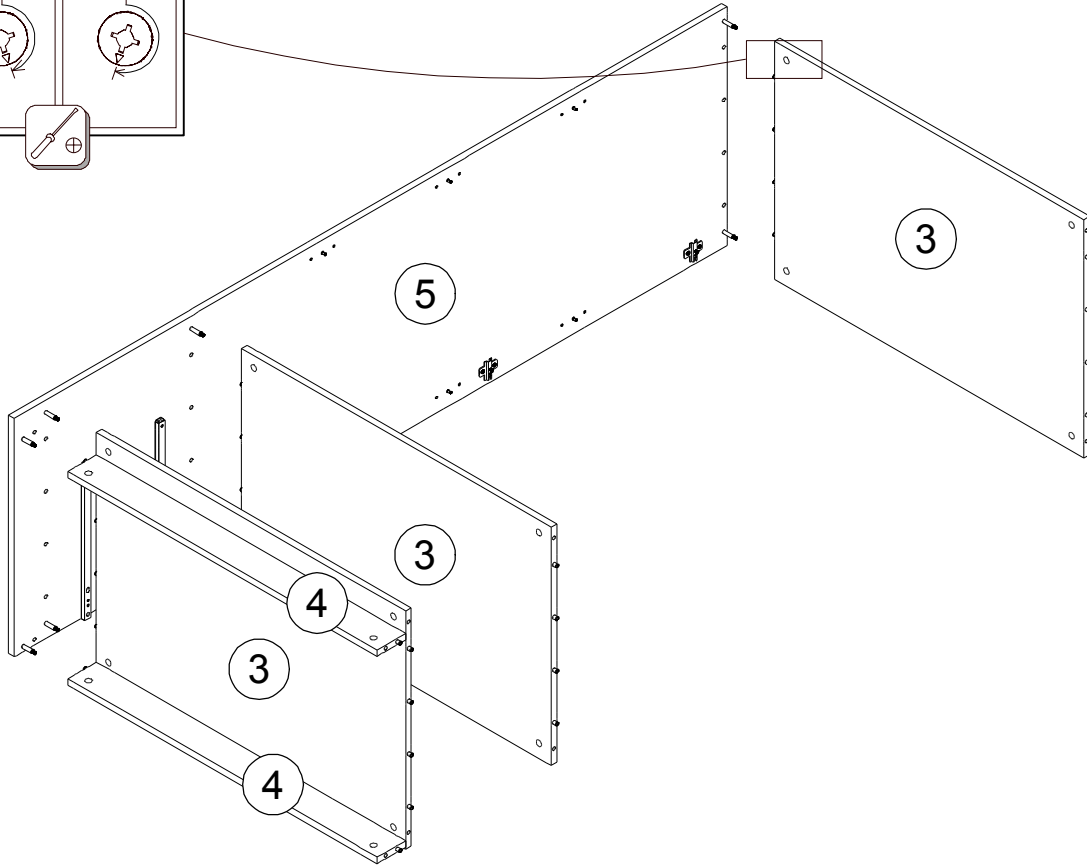
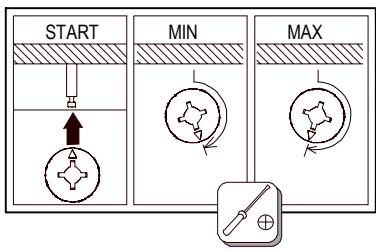
A 12x	B 28x	C 12x	D 16x	E 16x	F 8x	N 2x	P 6x	Q 6x	R 4x
U 8x	V 2x								



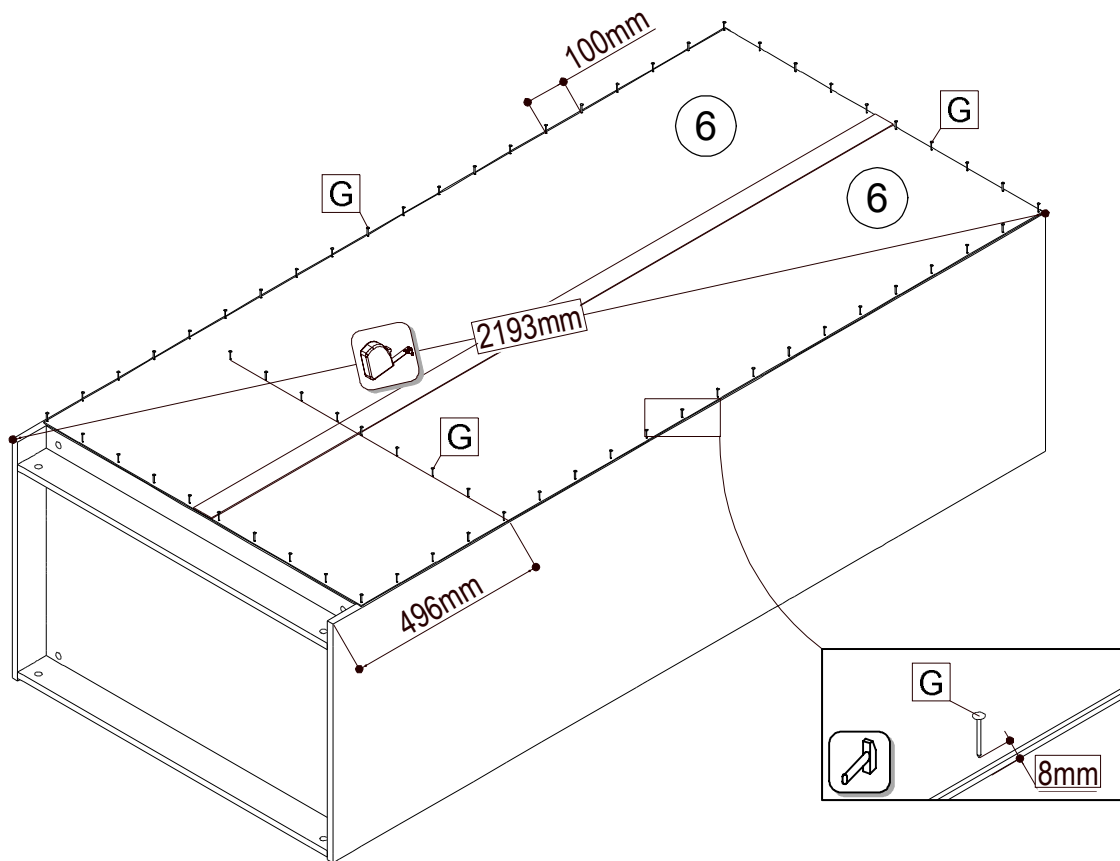



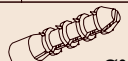

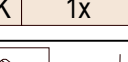
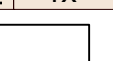

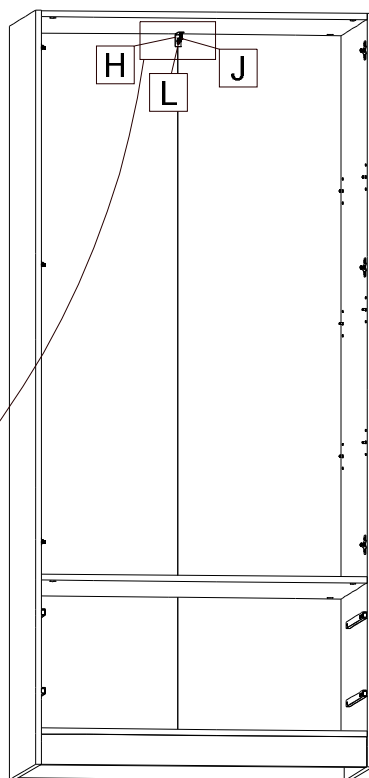
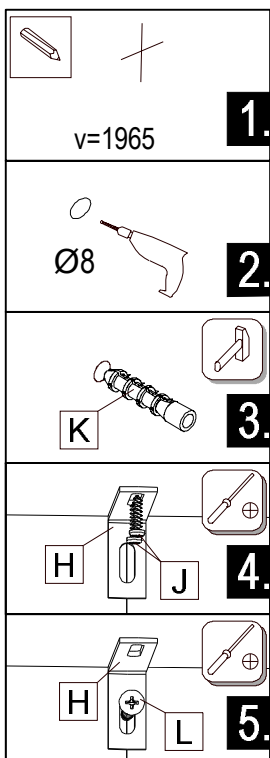
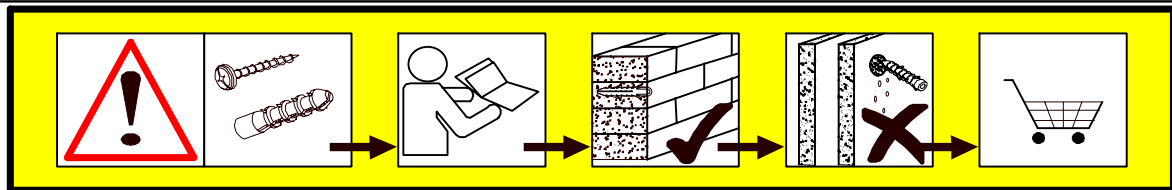
	Ø1,2x20
G	75x





	
H	1x
	
J	16x
	
K	1x
L	1x



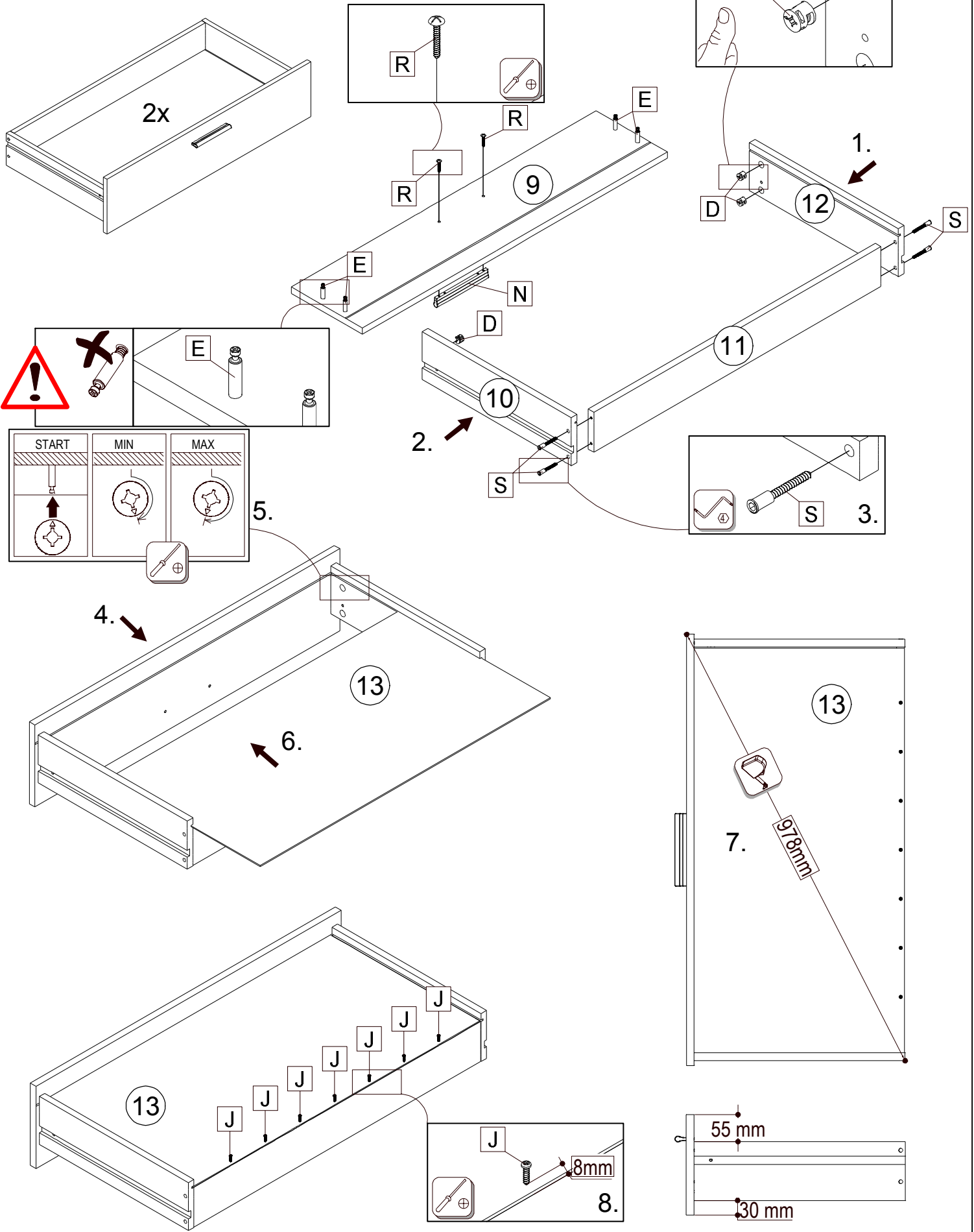

DE	<p>Achtung! Die Wandbeschaffenheit ist vor der Montage unbedingt zu prüfen. Die beigelegten Universaldübel sind ausschließlich nur zur Verwendung für festes Mauerwerk wie Beton/Ziegel. Die Mauerdübel dürfen nicht bei Mauerwerk wie Hohlraumziegel, Leichtbausteinen, Gipskartonplatte oder anderer Rahmenbauweise verwendet werden. Bei diesen Mauerwerken sind gegebenenfalls Spezialdübel zu verwenden! Diese sind in einem Fachgeschäft (Baumarkt) erhältlich. Bei Nichteinhaltung wird seitens Produzenten/Händler und Importeur keine Haftung übernommen.</p>
SK	<p>Upozornenie! Pevnosť steny sa musí pred montážou bezpodmienečne skontrolovať. Univerzálne hmoždenky, ktoré sú obsiahnuté v balení, používajte jedine pre pevné murivo ako je betón/tehla. Hmoždenky sa nesmú používať v prípade ľahkého staveného muriva, dutina tehla, u sádrokartónových dosiek alebo iných konštrukcií rámu. U týchto murív je nutné použiť špeciálne hmoždenky! Tieto je možné dostať v špeciálnych predajniach so stavebným materiálom (stavebniny). Pri nedodržaní pokynov nepreberajú výrobcovia/predajci a dodávateľa zodpovednosť za vzniknuté škody.</p>
HU	<p>Vigyázat! Szerelés előtt a falfelületet feltétlenül vizsgálja meg. A mellékelt univerzális tipl kizárólag stabil falazathoz használható mint például beton/tégla. A fal tipl nem használható könnyű építőkövek hez, üreg tégla, gipszkarton lapokhoz vagy más fávázás építményekhez. Ezekhez a falfelületekhez csak speciális tiplik használhatóak, melyek szaküzletekben (barkácsruházakban) beszerezhetőek. Fentiek figyelmen kívül hagyása esetén a gyártó/kereskedő vagy forgalmazó nem vállal felelősséget.</p>
CZ	<p>Upozornění! Před montáží je nutné zkontrolovat stav stěny. Příložené univerzální hmoždinky jsou určeny pouze k použití pro pevné zdivo jako beton/cihly. Hmoždinky do zdi se nesmí používat u dutinová cihla, zdiva jako pórovitý stavební kámen, sádrokartónová deska nebo jiný měkký materiál. U těchto zdív jsou nutné použít speciální hmoždinky! Jsou k dostání v speciálních prodejnách se stavebním materiálem. Při nedodržení těchto pokynů výrobce/prodejce a dovozce neručí za způsobené škody.</p>

					
D 8x	E 8x	J 14x Ø3,5x16	N 2x	R 4x Ø4x25	S 8x Ø7x50

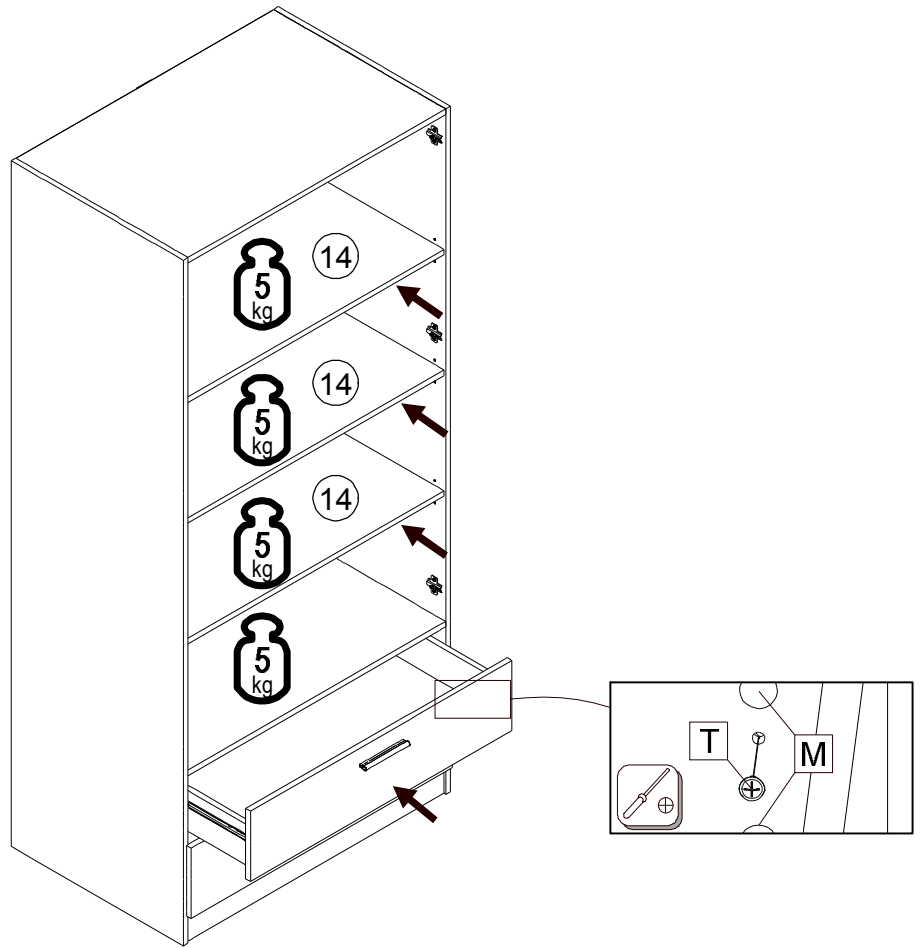

	
M 8x	T 4x



M 4x

