

A
x8

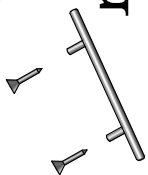

G
x1



LA
x2

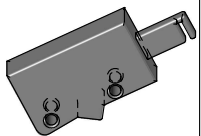

B
x8



H

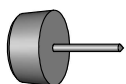

C
x30

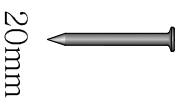

I

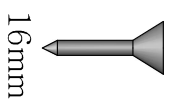

D
x4



J
x4

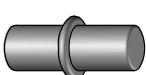

E
x4

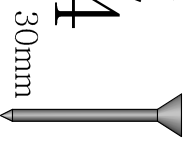

K

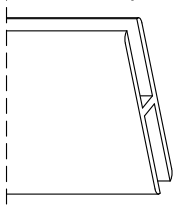

F



x2

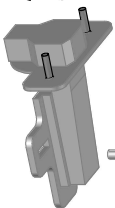

L

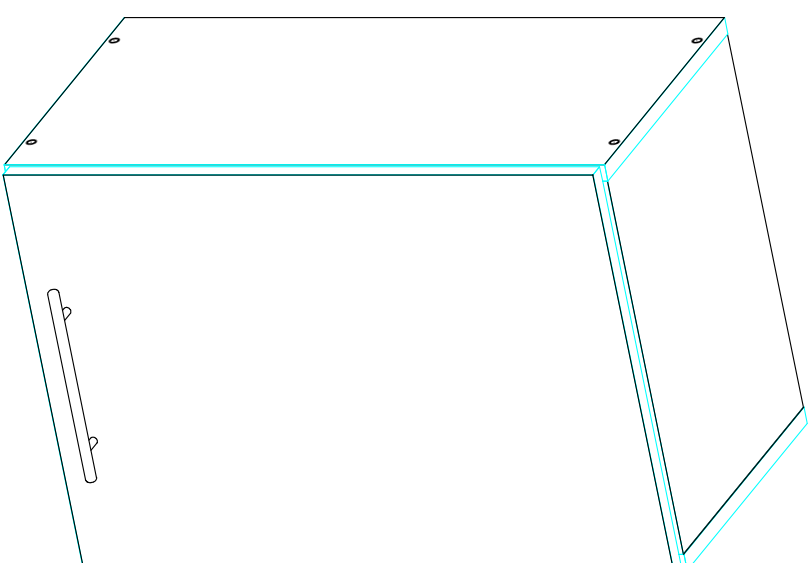
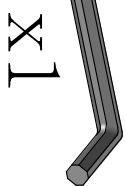

Montážny návod



1/1

Je potrebné použiť kladivo a šraubovák.

G40-P-

Promo

Skriňky montujte podľa krokov v montážnom návode.

260cm

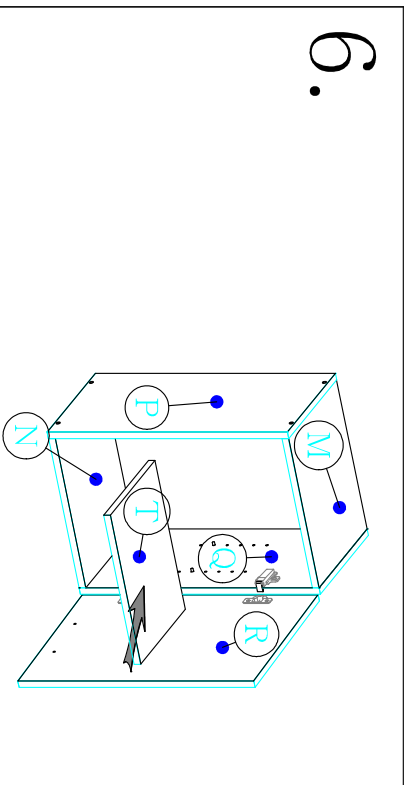
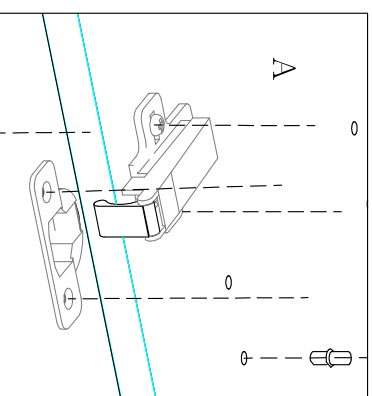
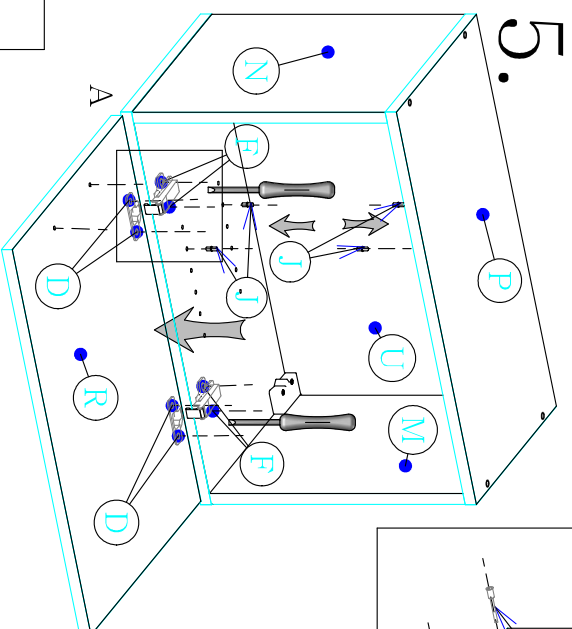
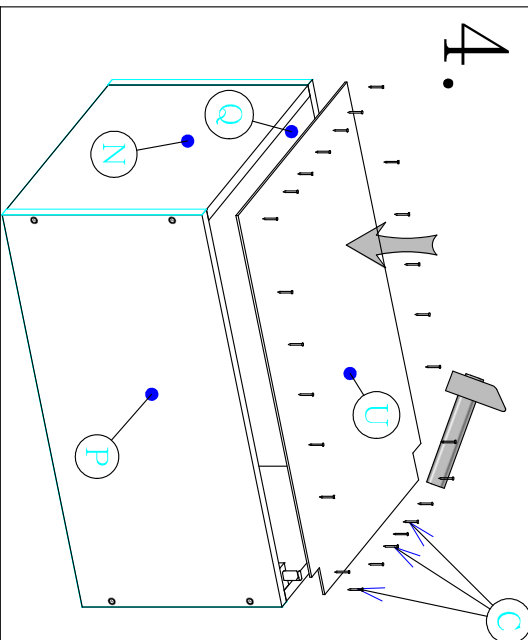
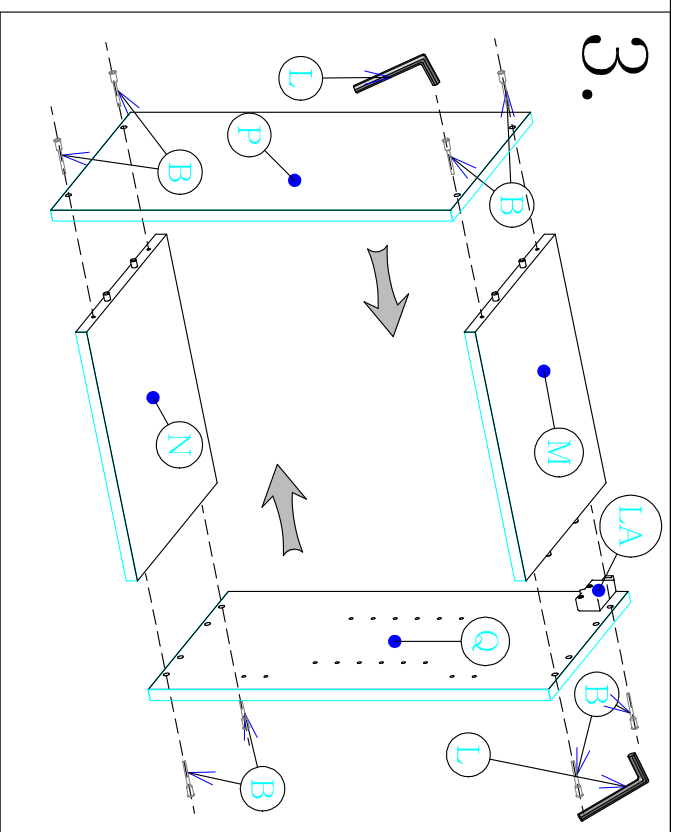
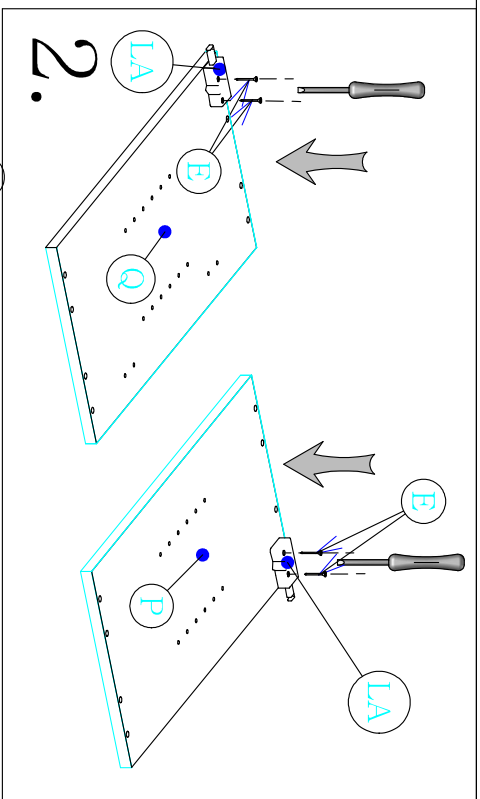
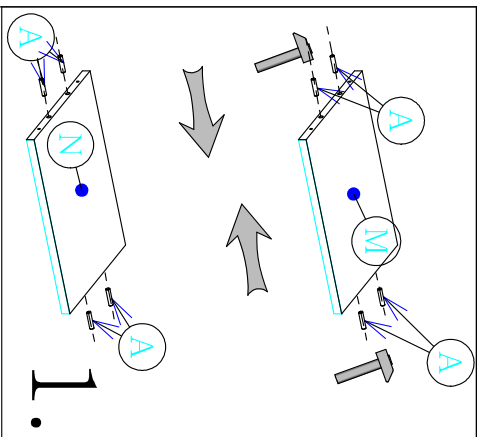

Montážny návod



1/1

Je potrebné použiť kladivo a šraubovák.

Skrinky montujte podľa krokov v montážnom návode.

G40-P

Promo

260cm