

Montážny návod



1/1

D40SZ-

Je potrebné použiť kladivo a šraubovák.

Promo

Skrinky montujte podľa krokov v montážnom návode.

260cm

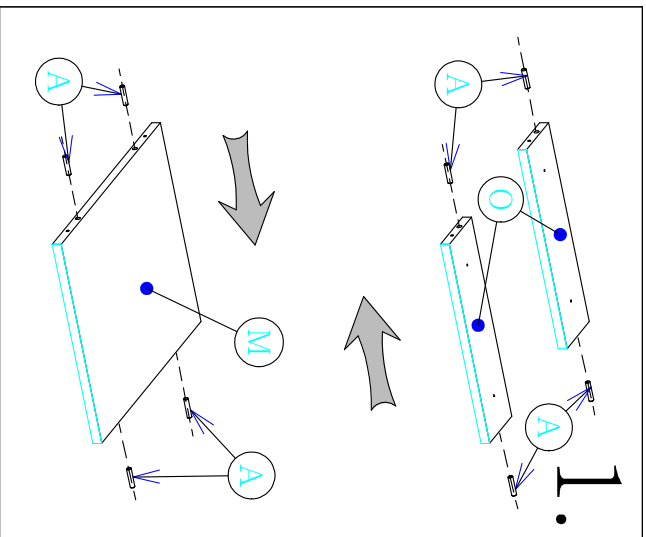

1. 2.

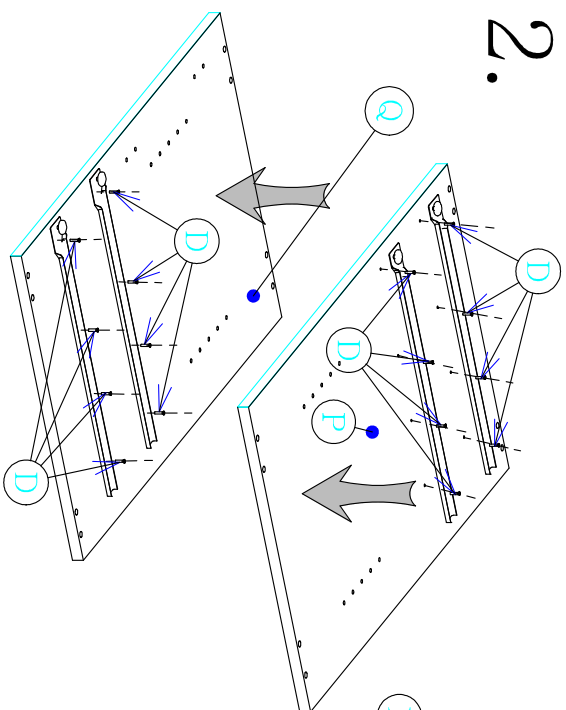

3.

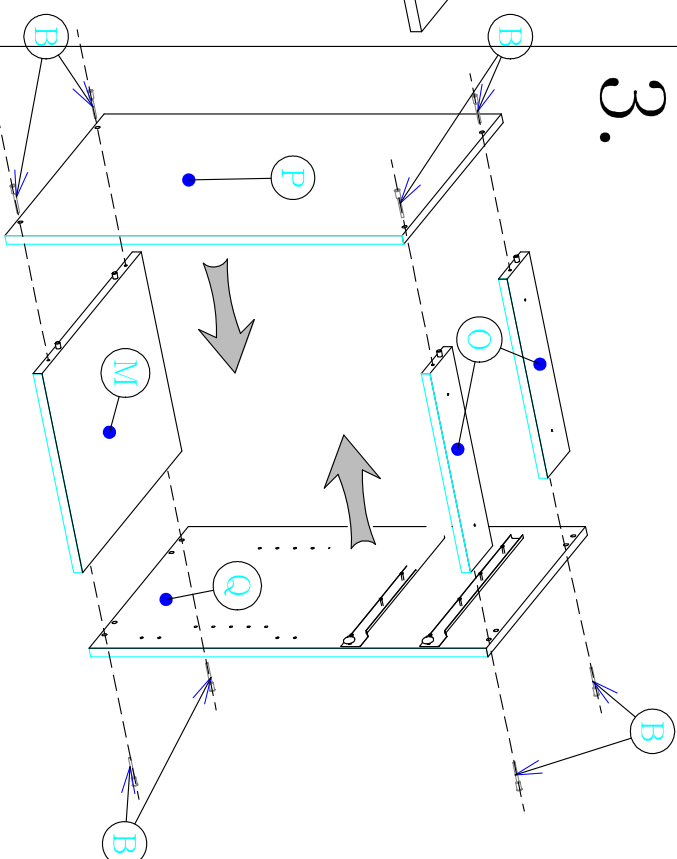

4.

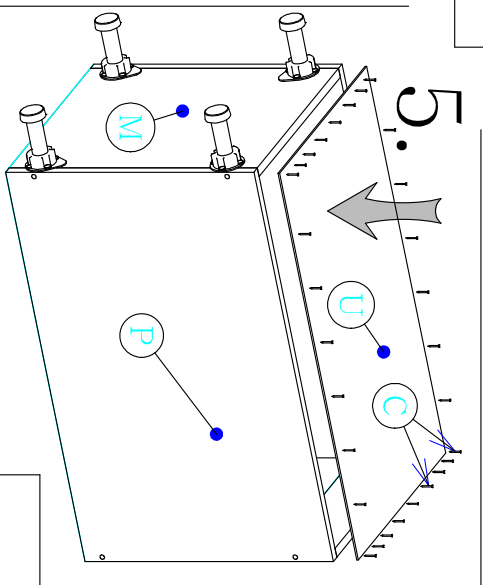
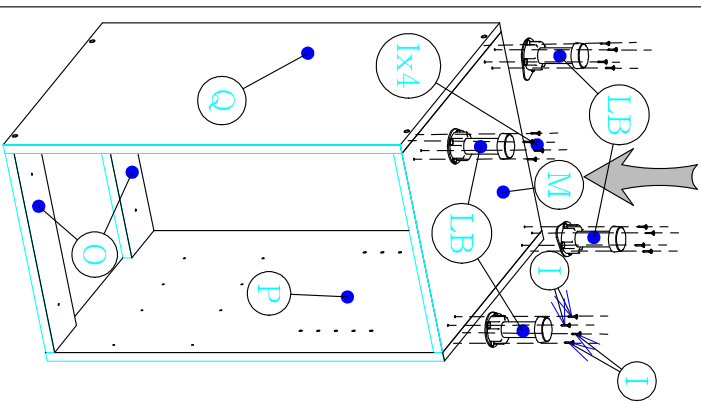

5.

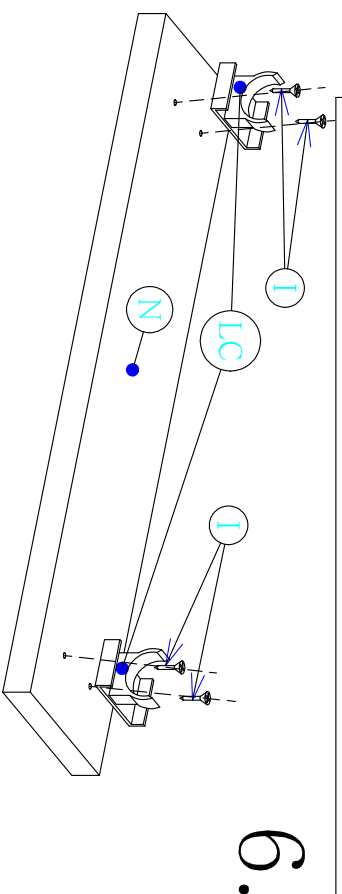

6.

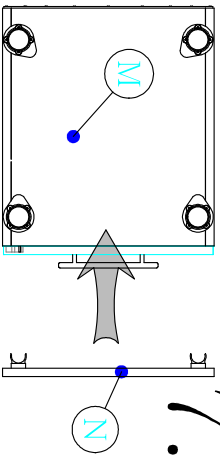

7.

Montážny návod



1/2

Je potrebné použiť kladivo a šraubovák.

Skrinky montujte podľa krokov v montážnom návode.

D40SZ

Promo

260cm

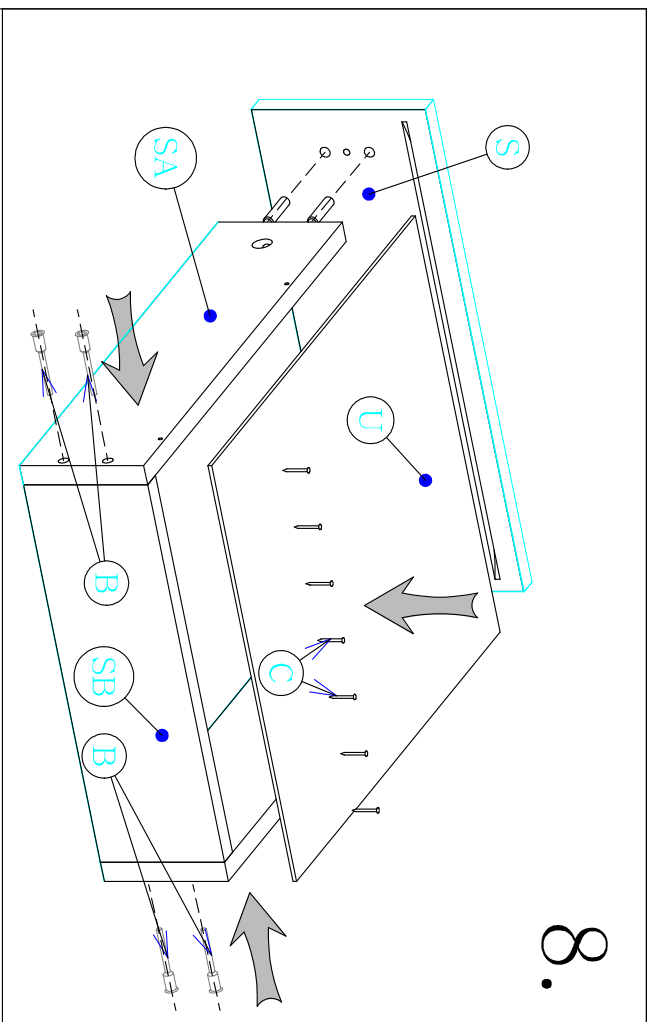

8.

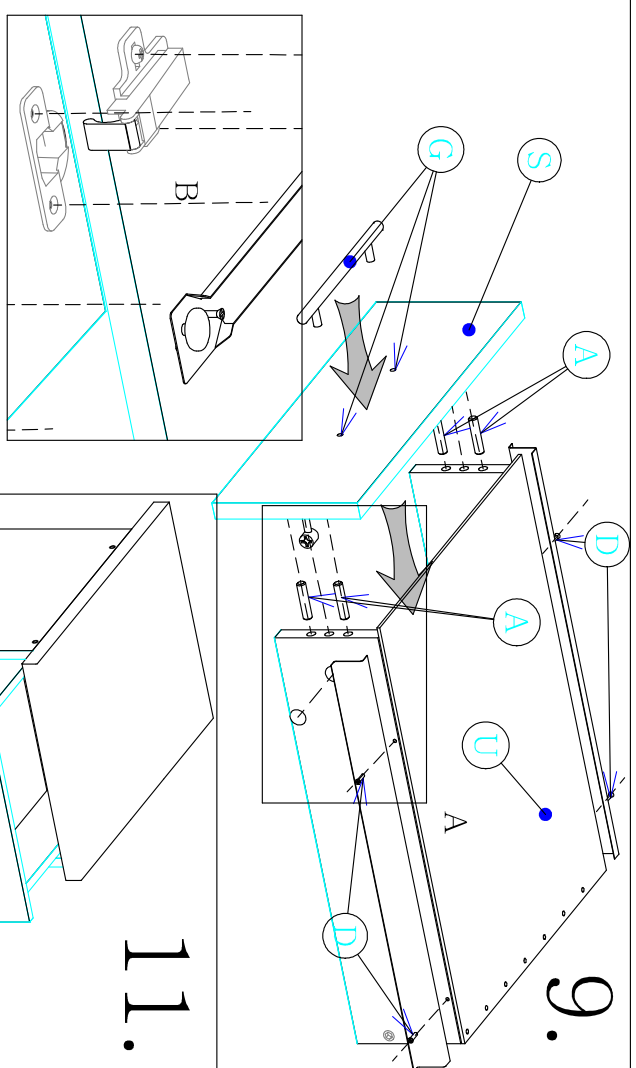

9.

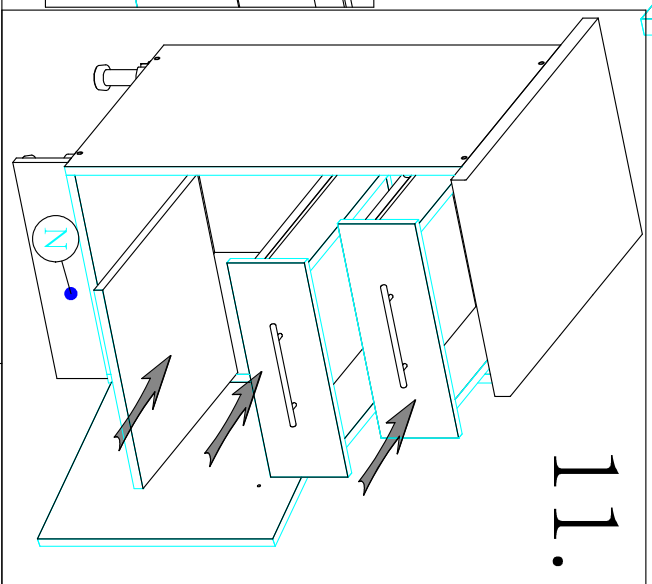
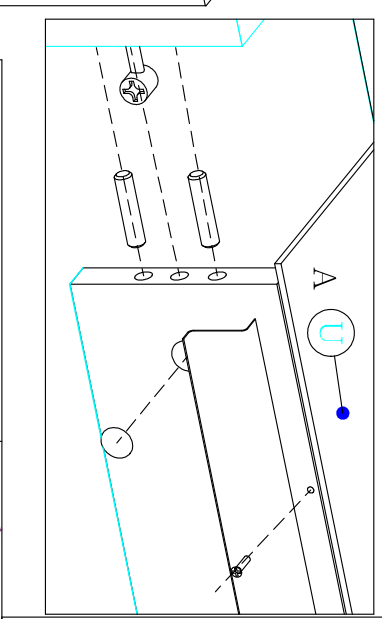

11.

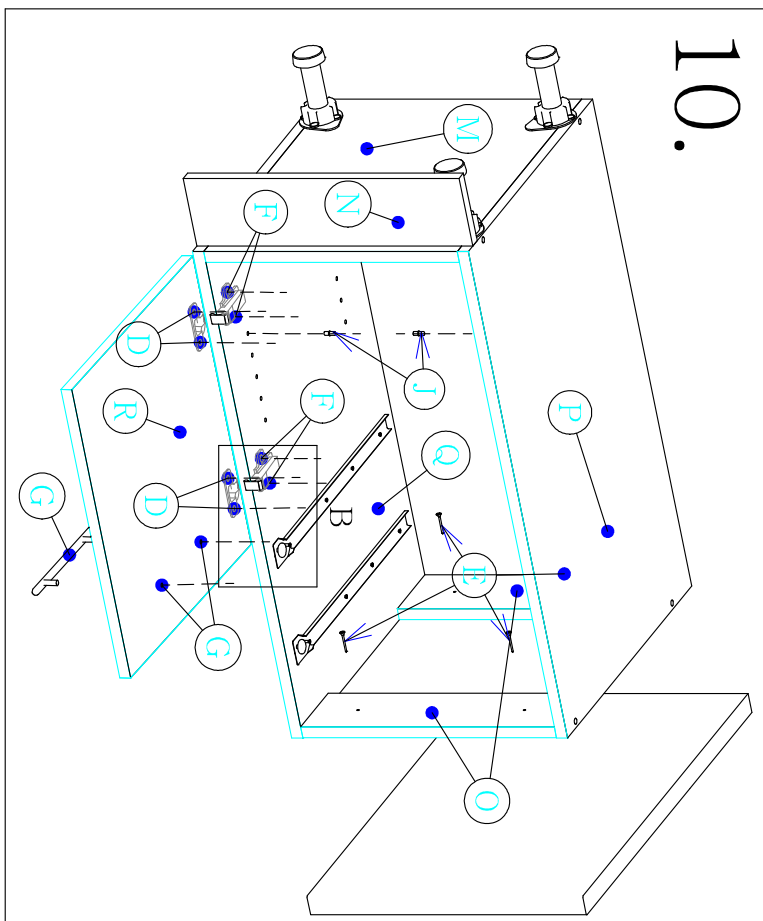

10.

Montážny návod				2/2
D40SZ	260cm			
Primo	260cm	Je potrebné použiť kladivo a šraubovák.		
		Skrinky montujte podľa krokov v montážnom návode.		