

KNIHOVNA-60310

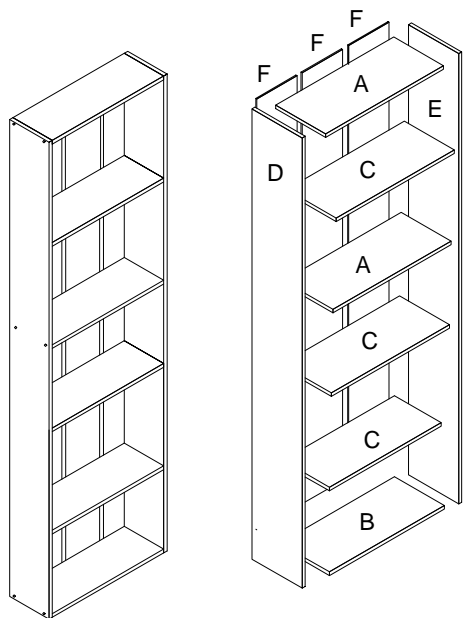

— 1x

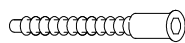

— 12x



— 12x



— 12x



— 40x



— 4x



2x

1.)

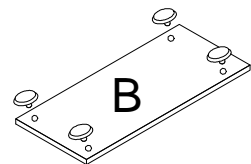
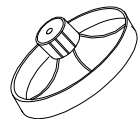

2.)

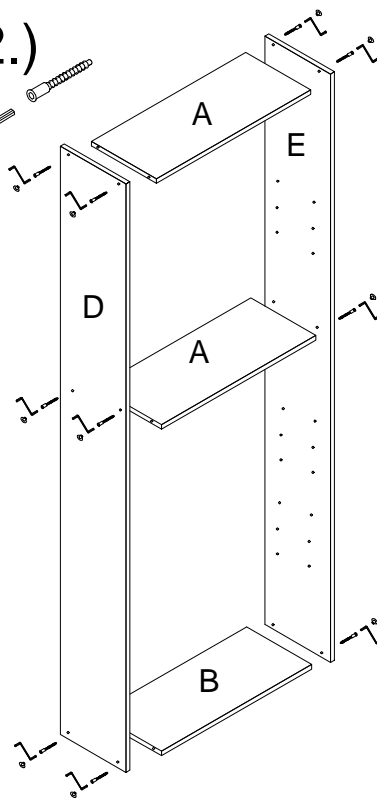

3.)

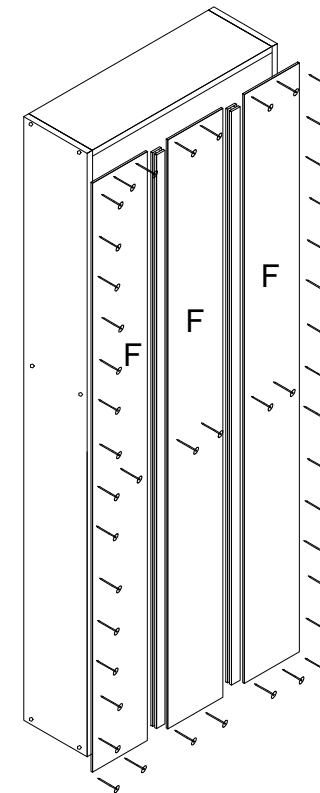
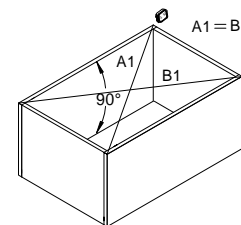
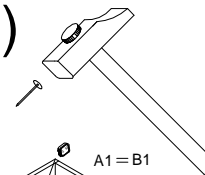

4.)

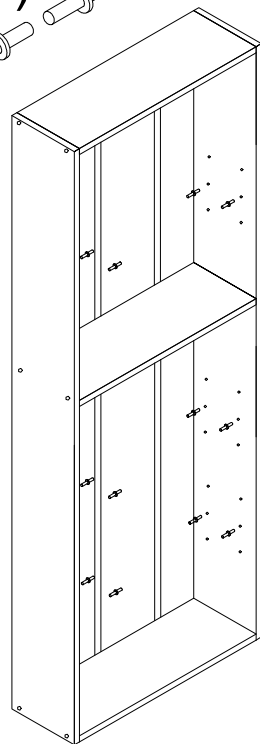
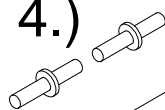

5.)

