

16313

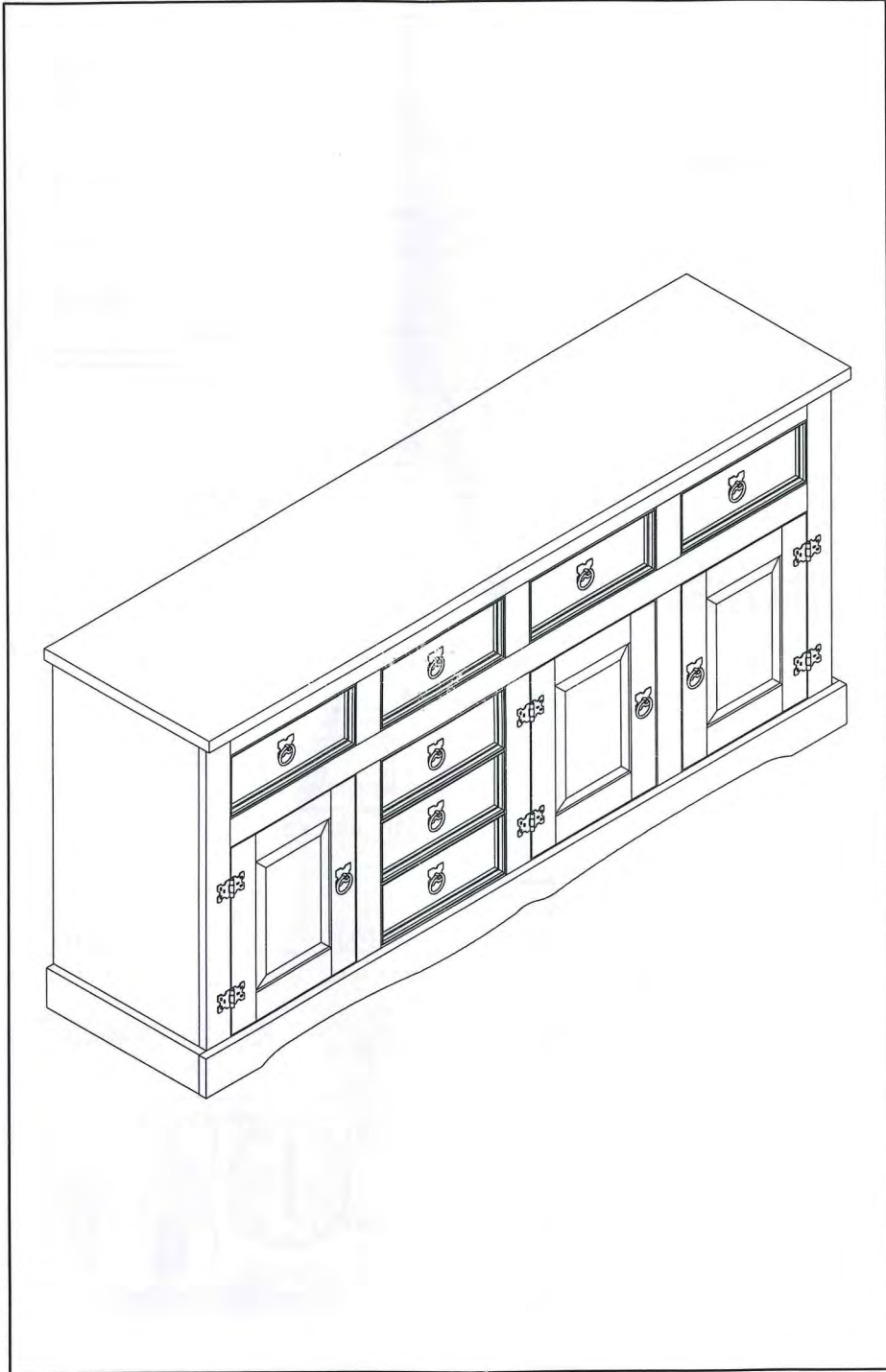

Ref.: 534

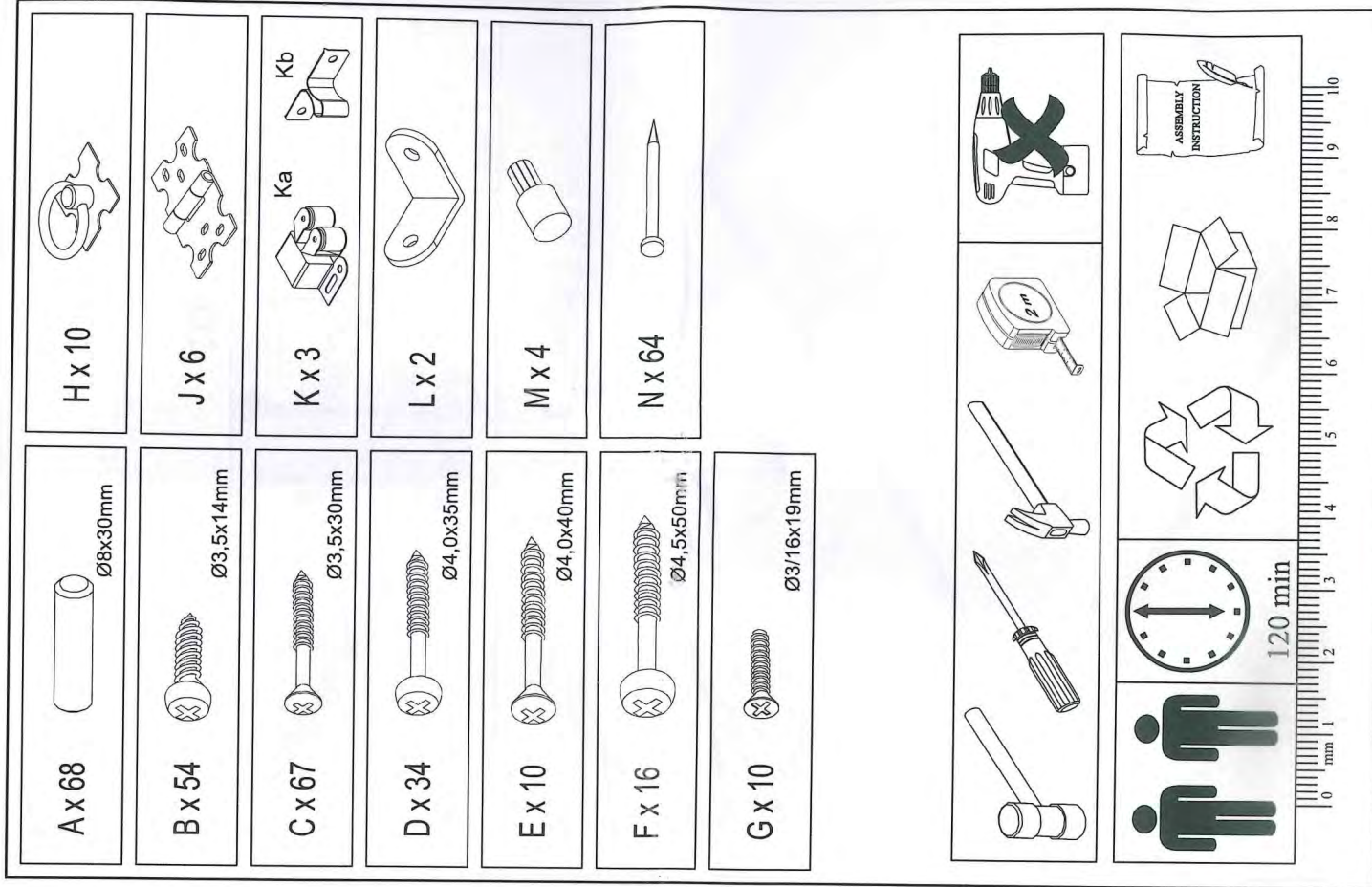
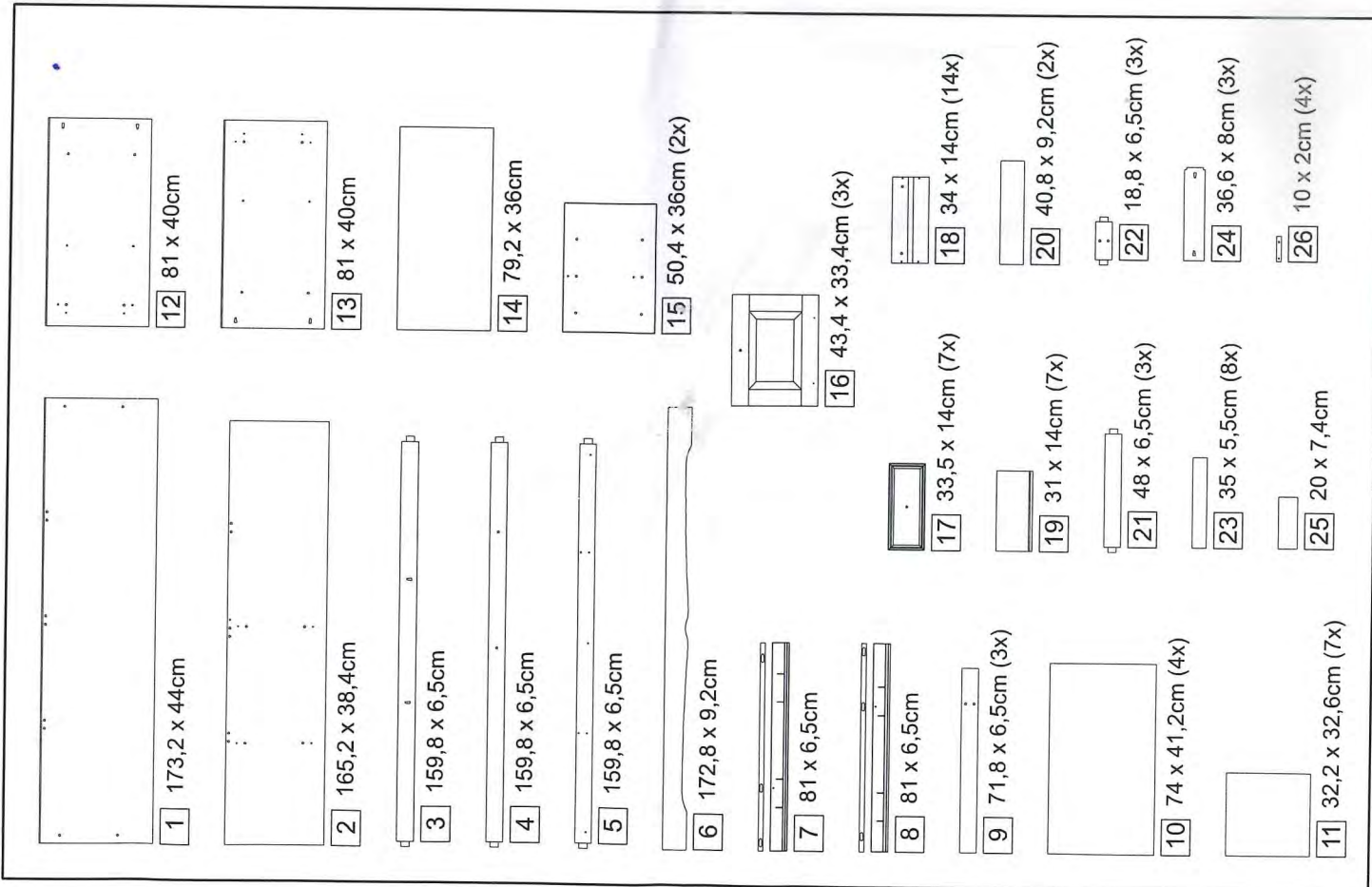

1

a:

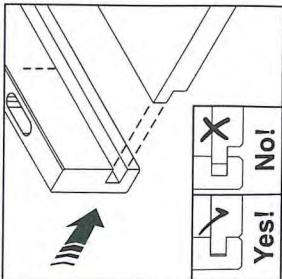

b:

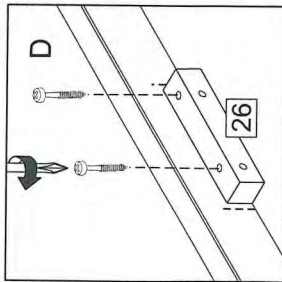

c:

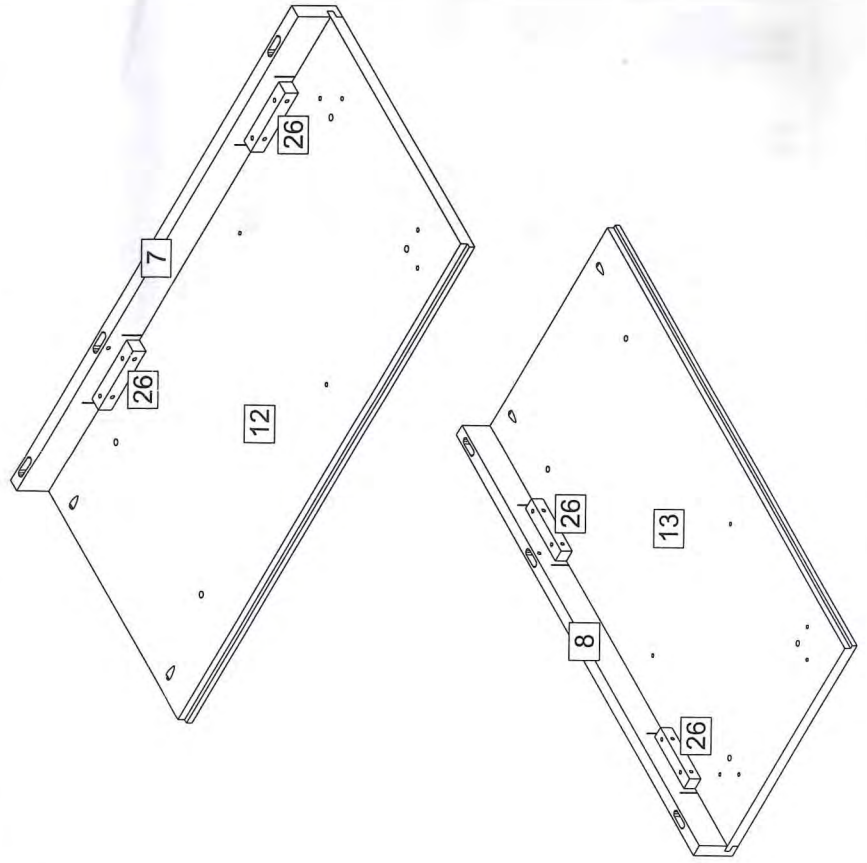
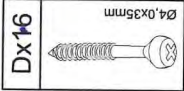
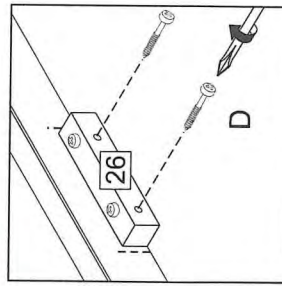

2

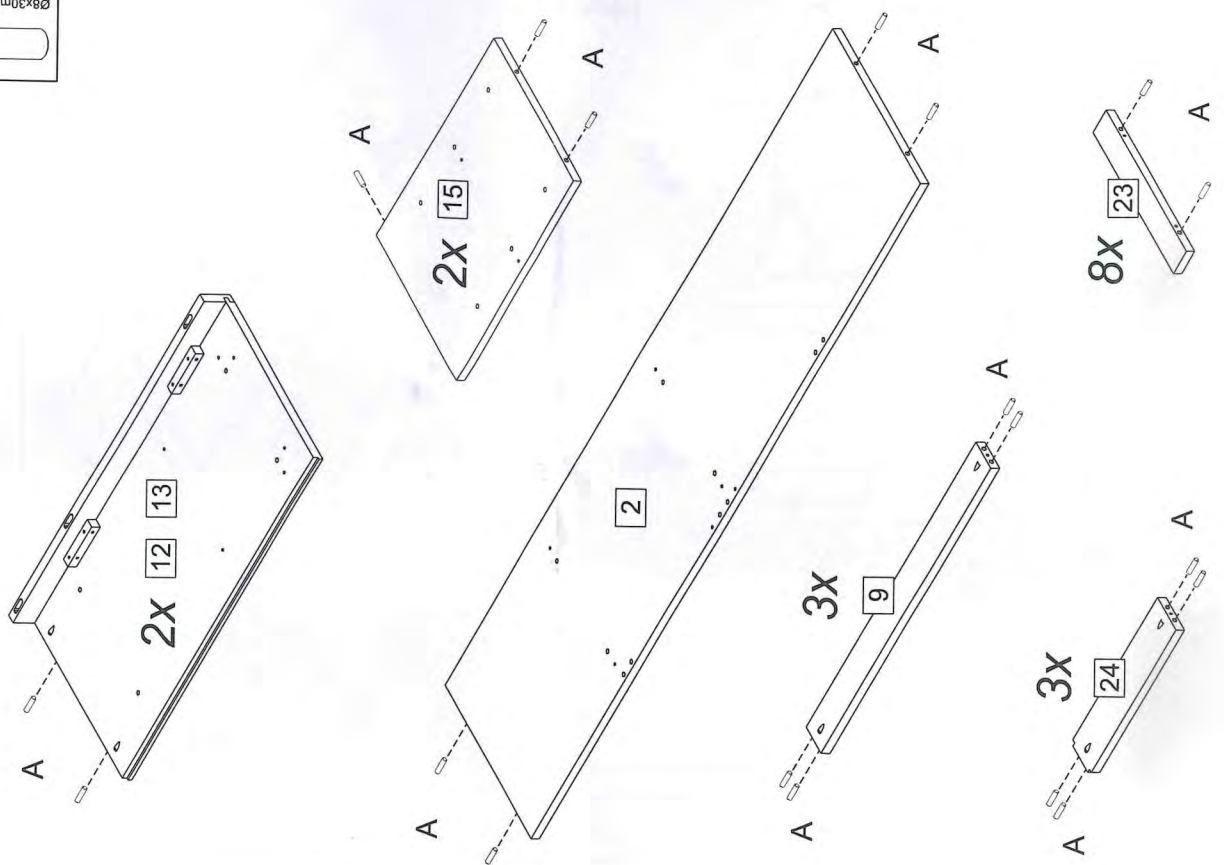
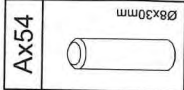

5

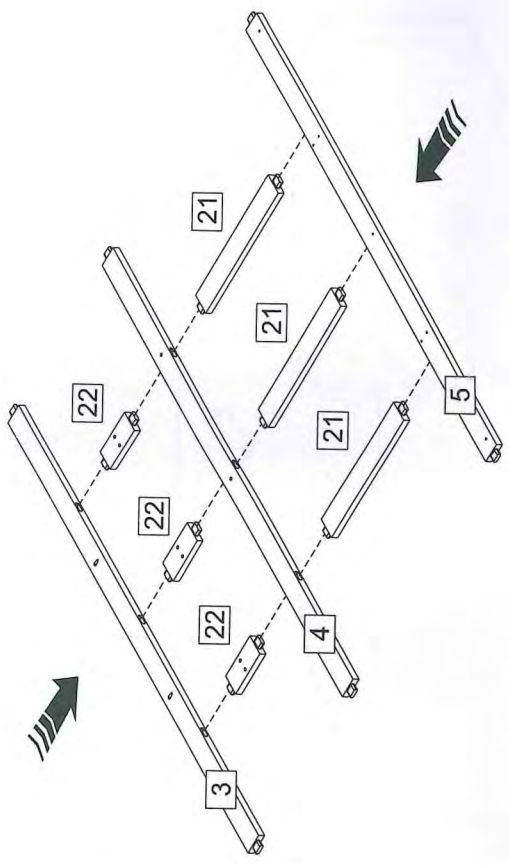

6

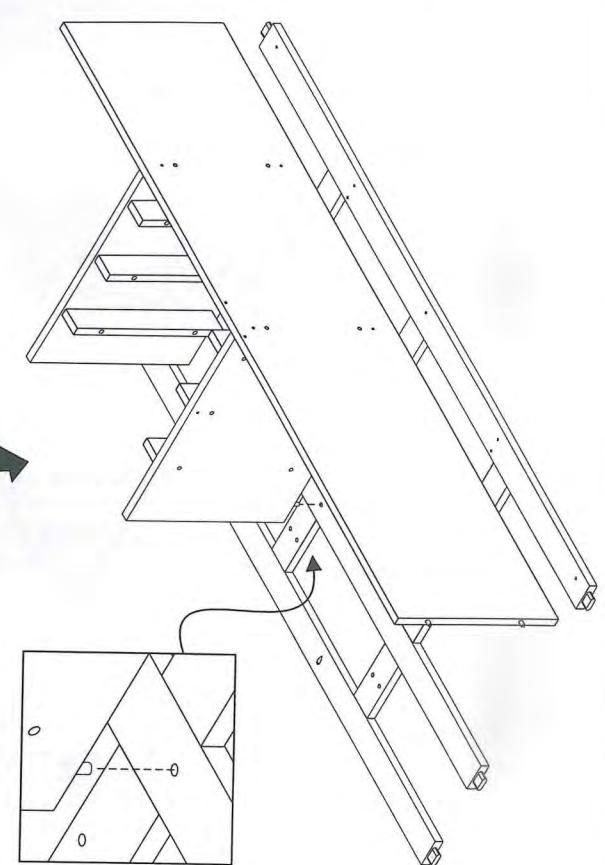

3

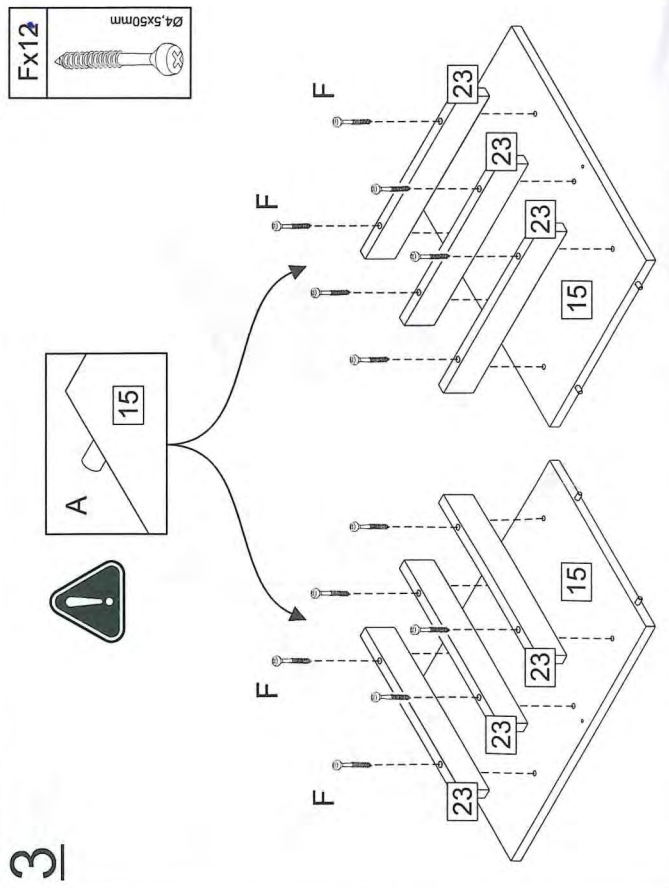

4

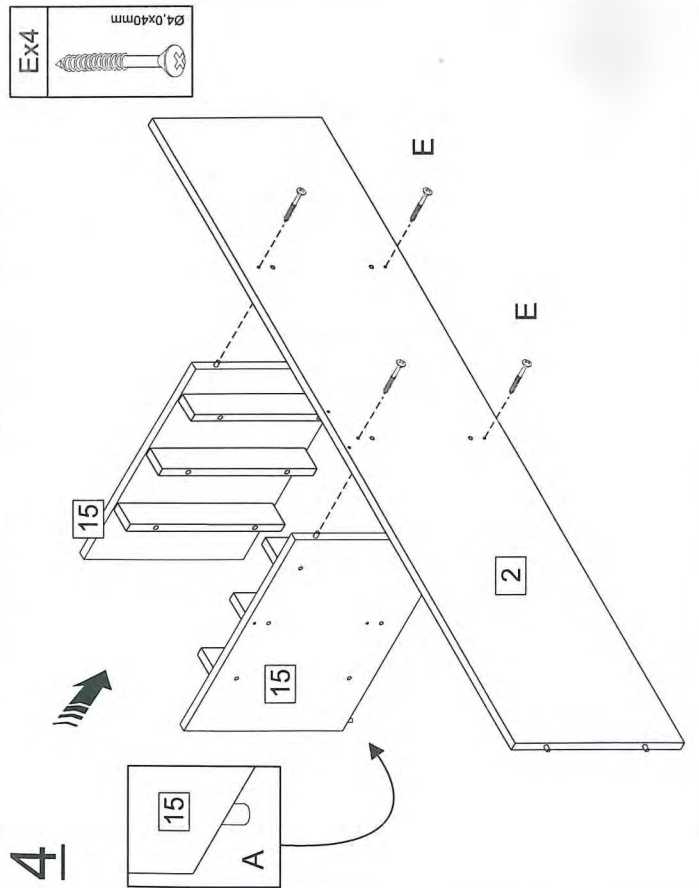

7

Ex2
Ø4,0x40mm

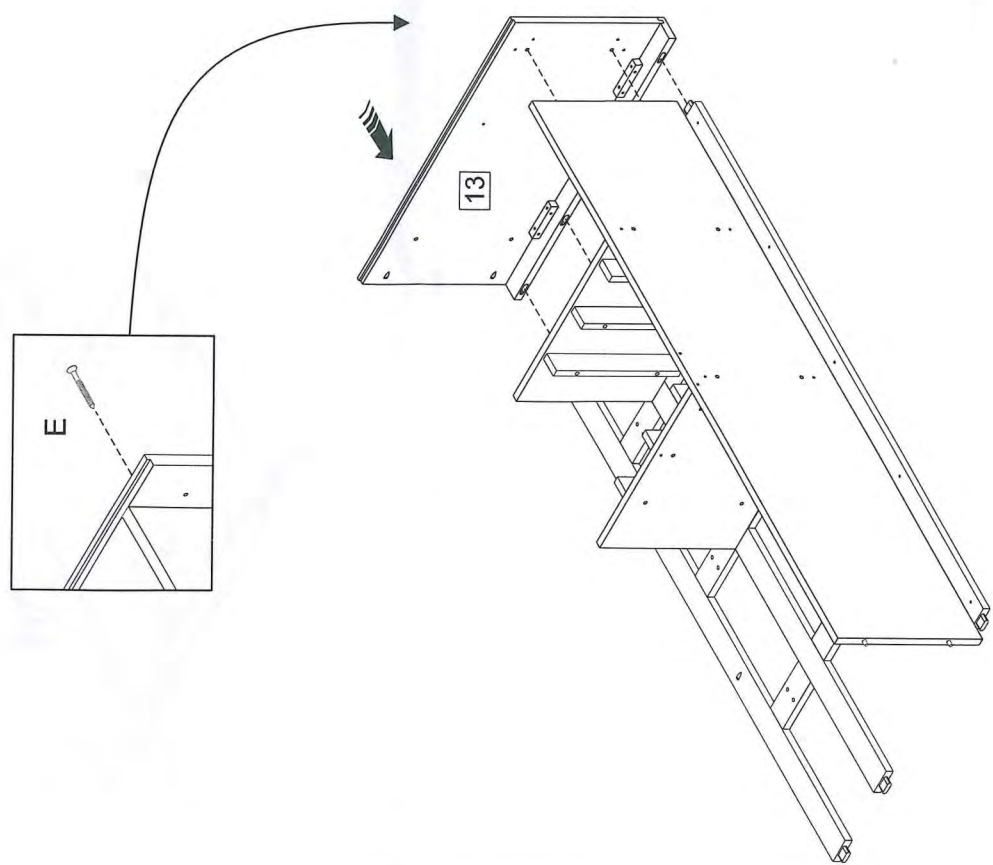

8

Ex4
Ø4,0x40mm

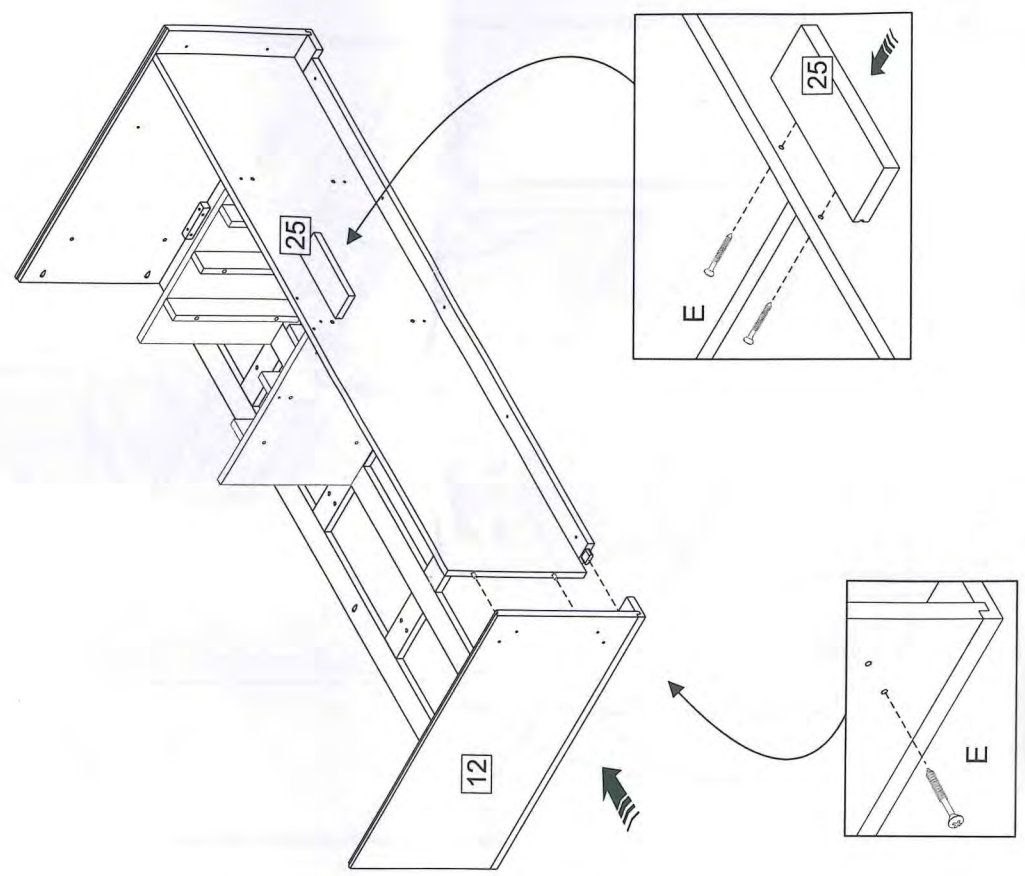

9

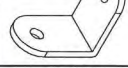
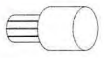
| | | |
|---|---|---|
| Bx6 | Lx2 | Mx4 |
|  |  |  |

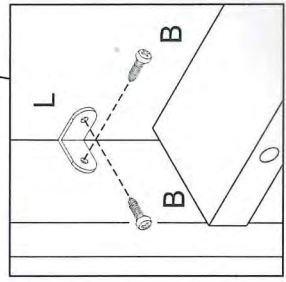
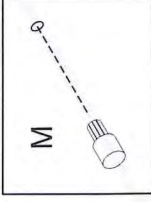
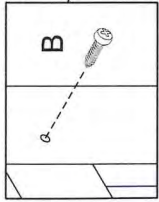
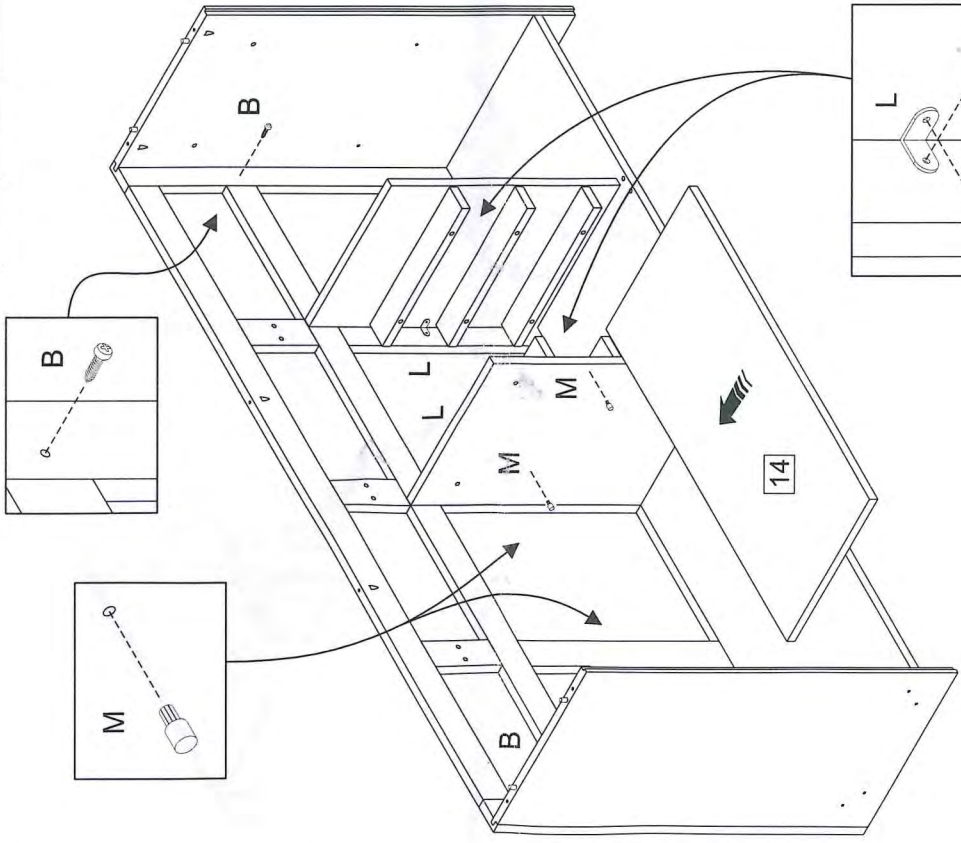

10

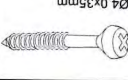
| |
|---|
| Dx3 |
|  |

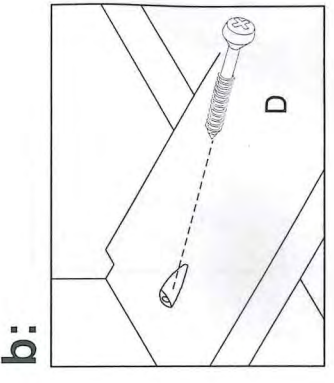
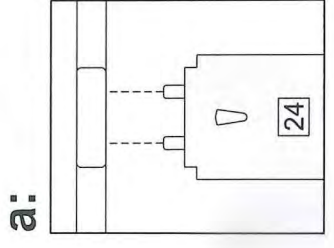
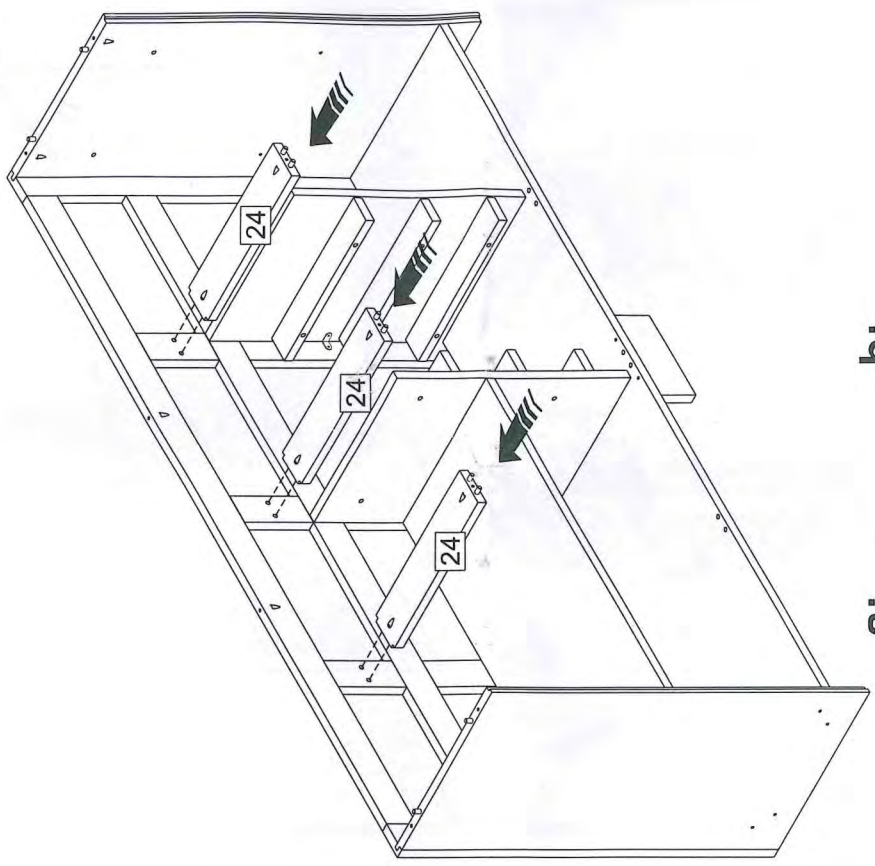

11

Dx3
Ø4,0x35mm

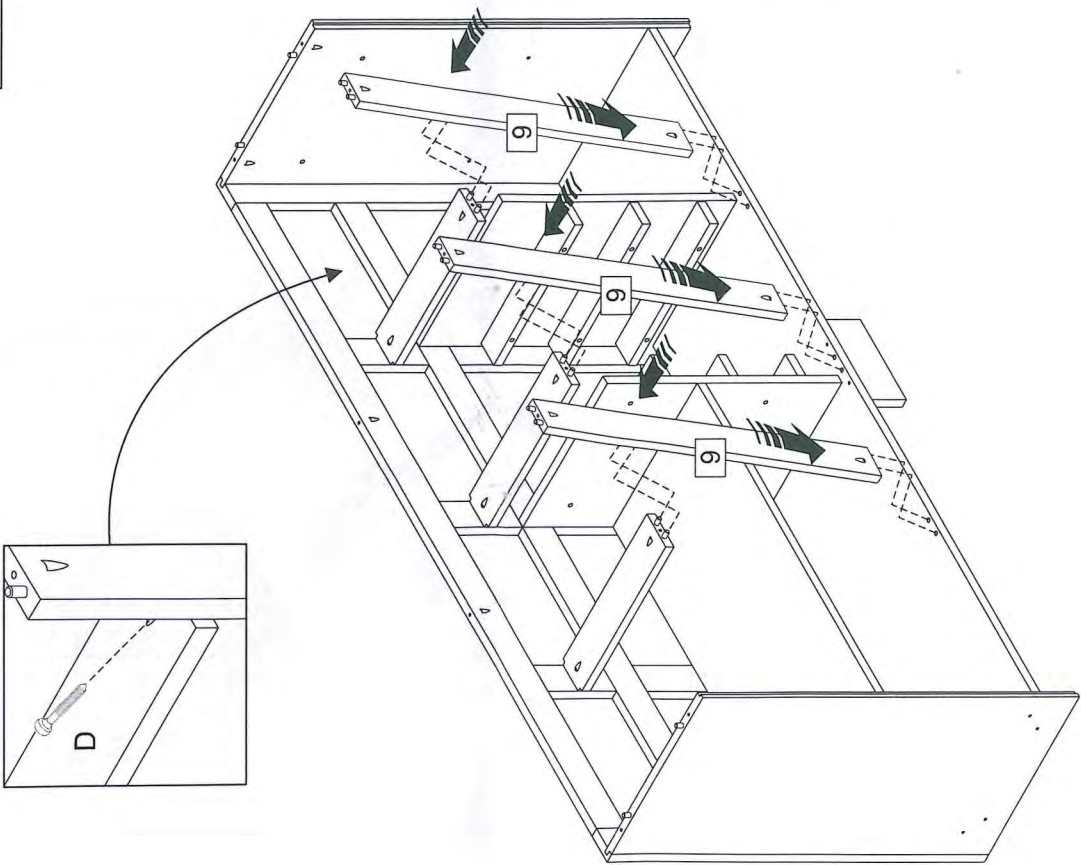

12

Dx12
Ø4,0x35mm

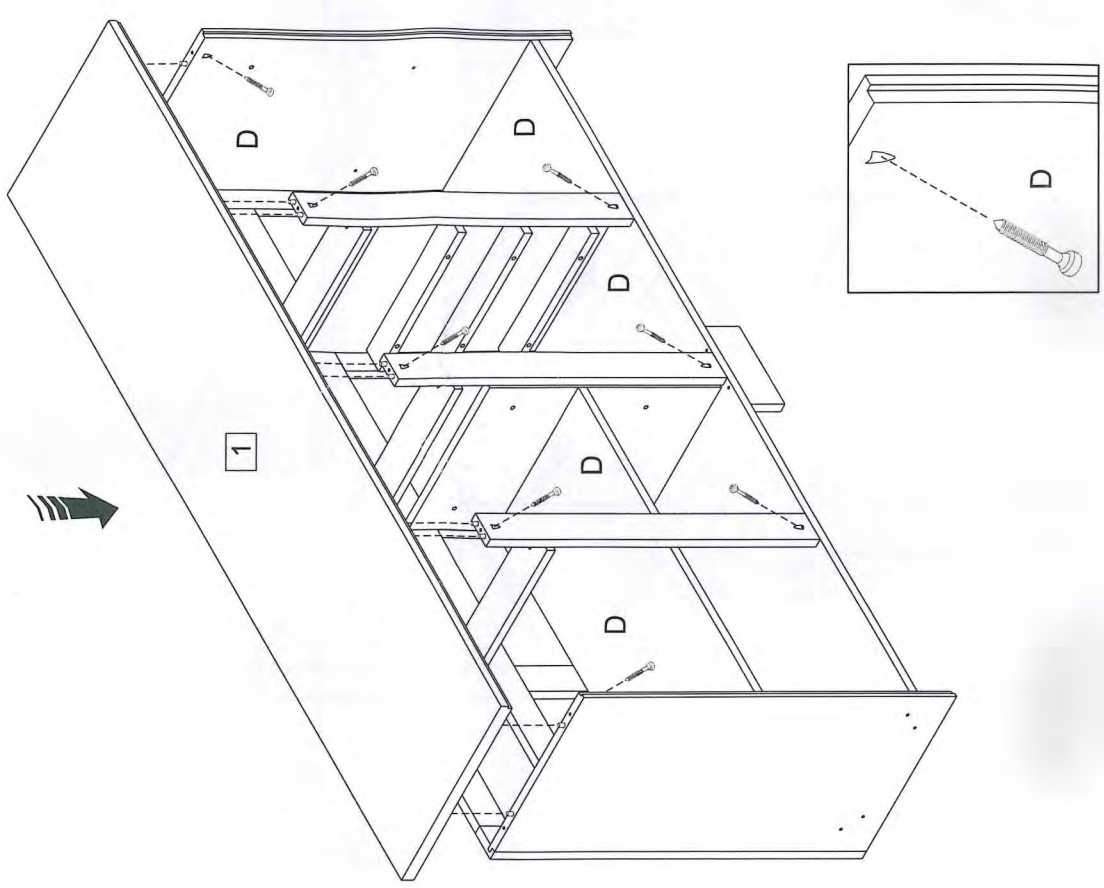

13

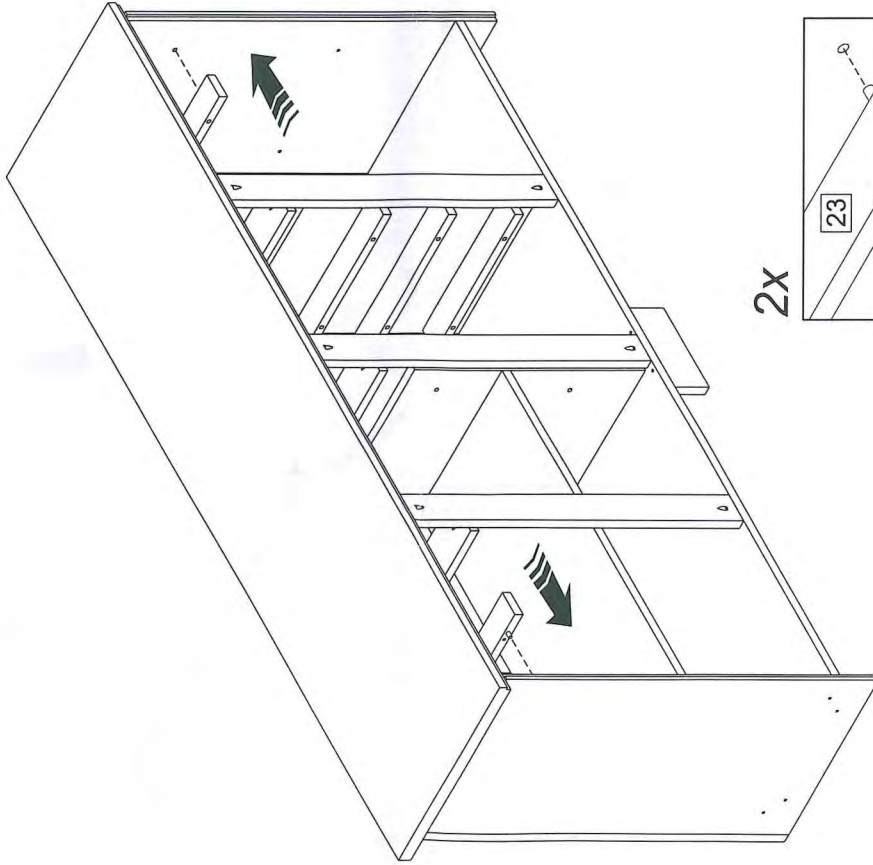
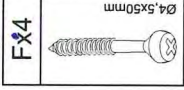

2X

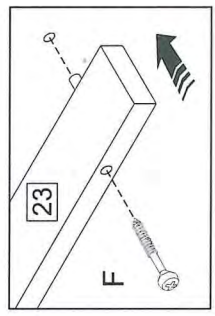

14

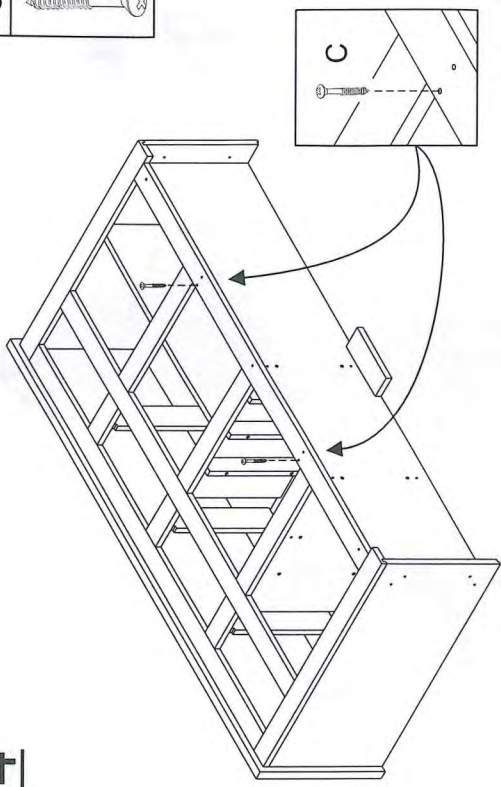
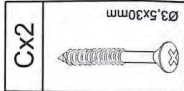

15

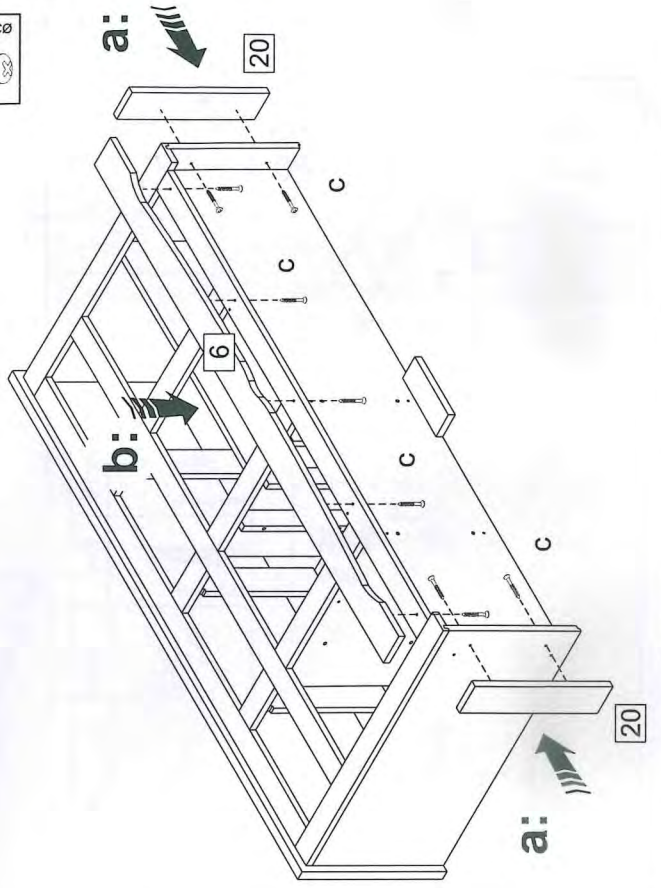
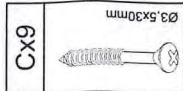

16

7x

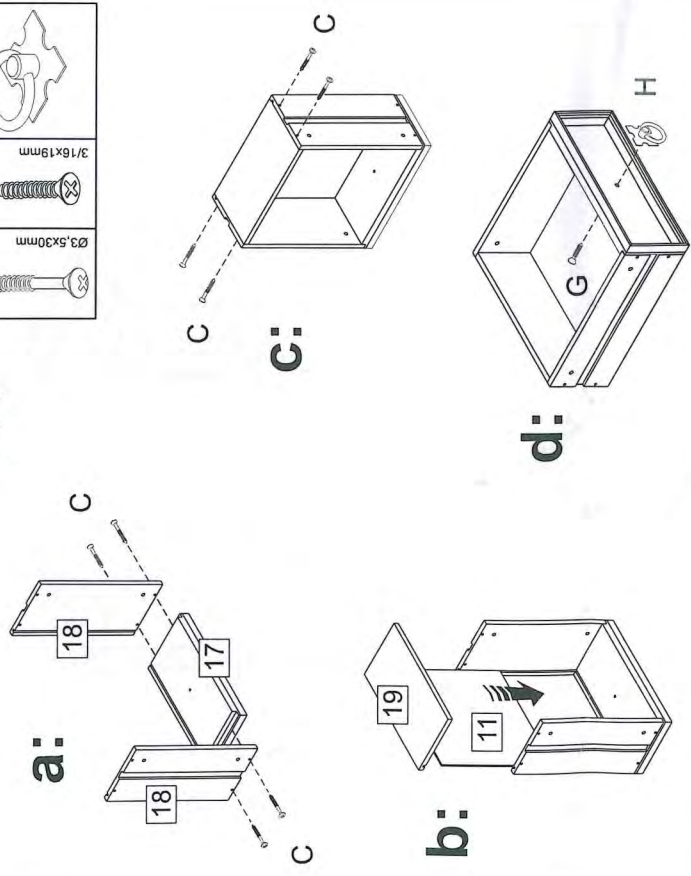

| | | |
|------|-----|-----|
| Cx56 | Gx7 | Hx7 |
| | | |

18

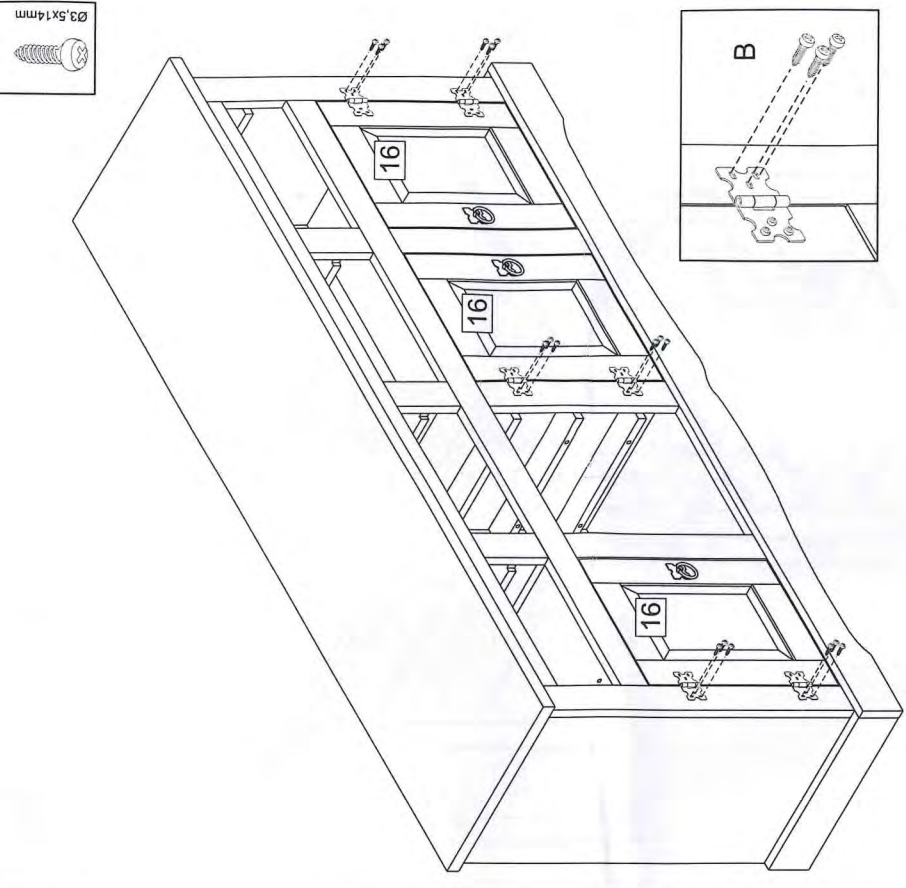

| | |
|------|-----------|
| Bx18 | Ø3.5x14mm |
| | |

17

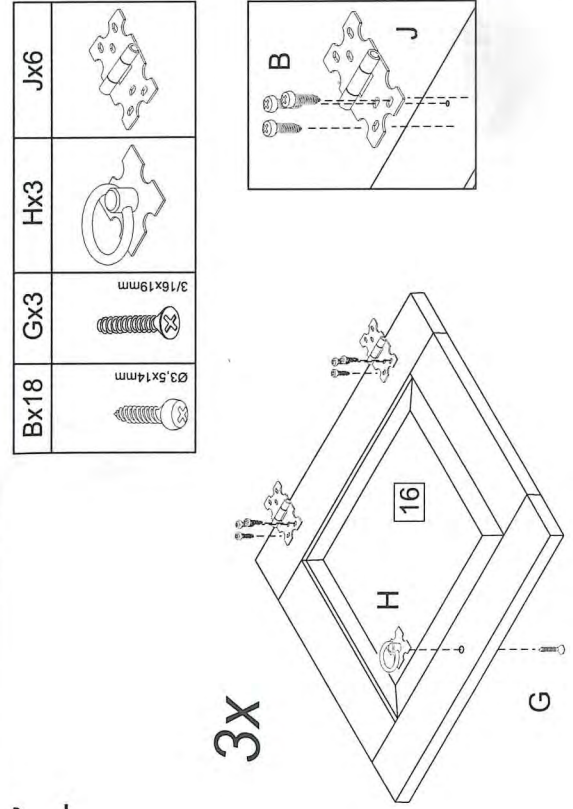

3x

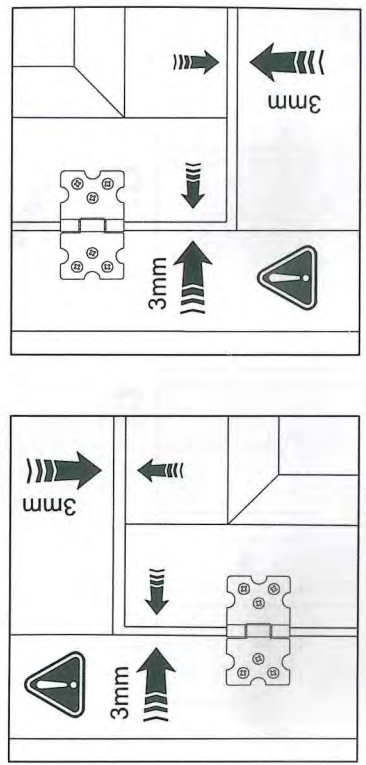

| | | | |
|------|-----|-----|-----|
| Bx18 | Gx3 | Hx3 | Jx6 |
| | | | |



19

| | | |
|---|---|---|
| Bx12 | Kax3 | Kbx3 |
|  |  |  |
| Ø3,5x14mm | | |

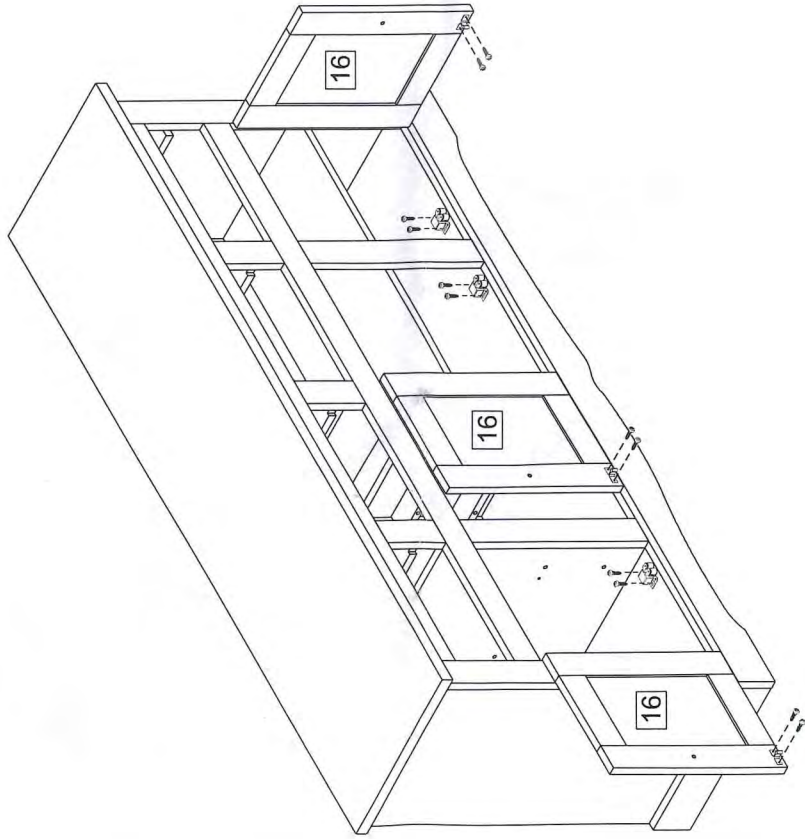

a:

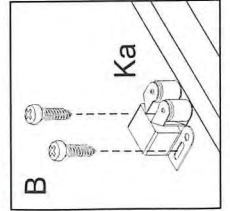

b:

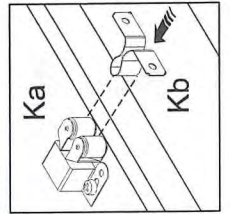

c:

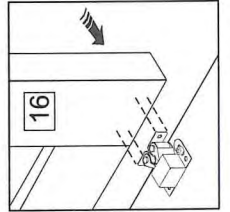

d:

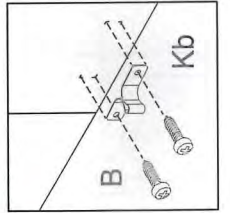

20

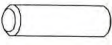
| | |
|---|---------|
| Ax14 | Ø8x30mm |
|  | |

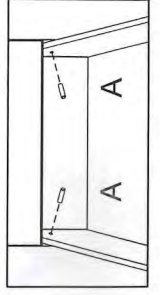
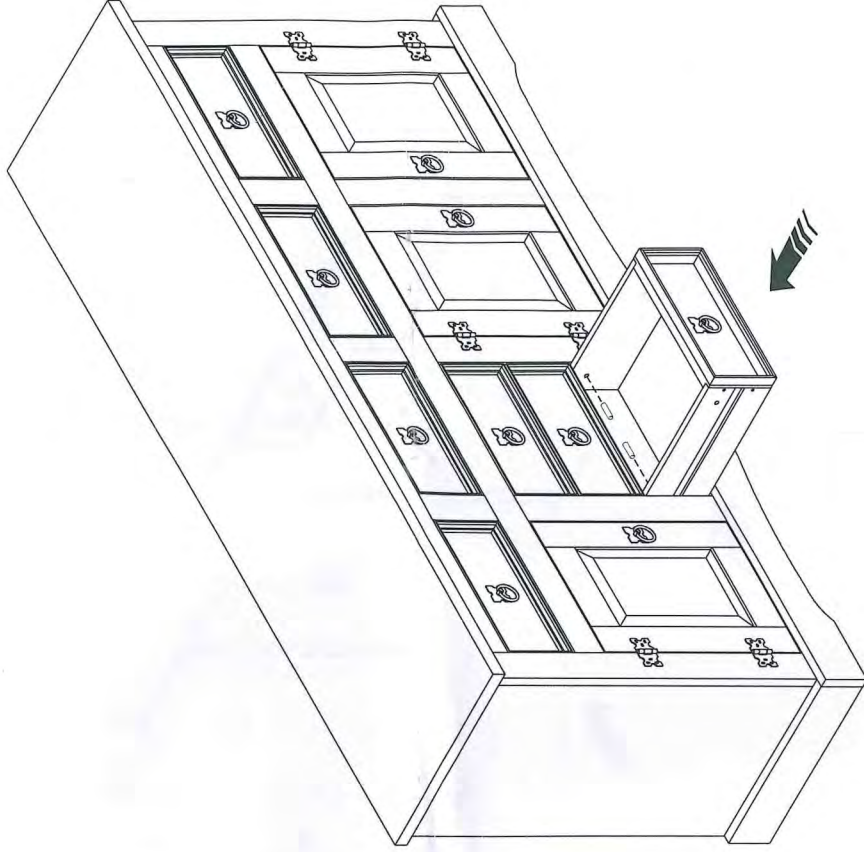

21

