

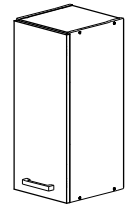

NOVA PLUS  
**NOPL-024-0H**





**!** V PŘÍPADO REKLAMÁCIE JE POTREBNÉ NAHLÁSIŤ  
 VÝROBNÉ ČÍSLO VIDITEĽNÉ NA ETIKETE **!**

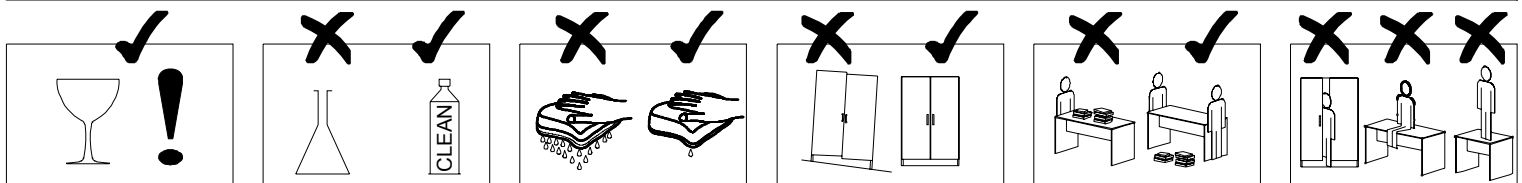
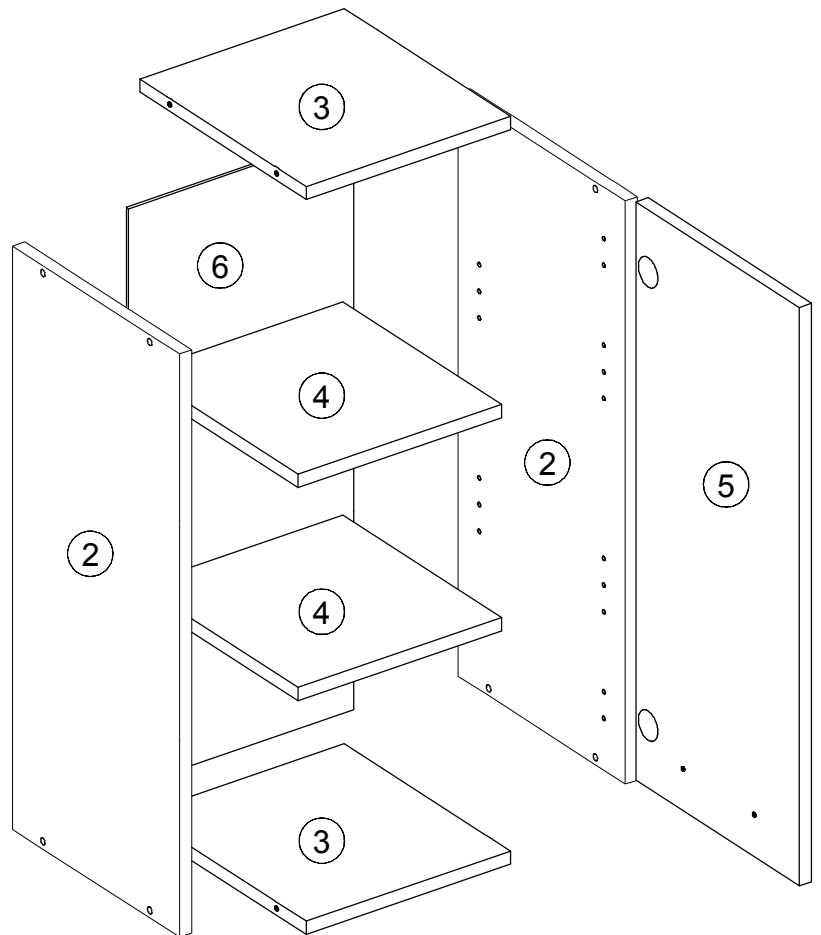

A 8x	B 8x	C 20x Ø1,6x20	D 1x	E 2x	F 2x	G 8x	H 8x Ø3,5x15	J 2x Ø10	K 2x
L 2x Ø5x60	1h 15min	2	4	5,5 x 125	≤ 0,5 kg	0,6m	3m		Ø10mm

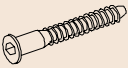
ID	Part	Dimensions	Qty	Unit
00302	2	700*300*16	2x	1/1
02508	3	418*299*16	2x	1/1
00984	4	418*285*16	2x	1/1
00985	5	694*446*16	1x	1/1
00986	6	694*446*2,5	1x	1/1

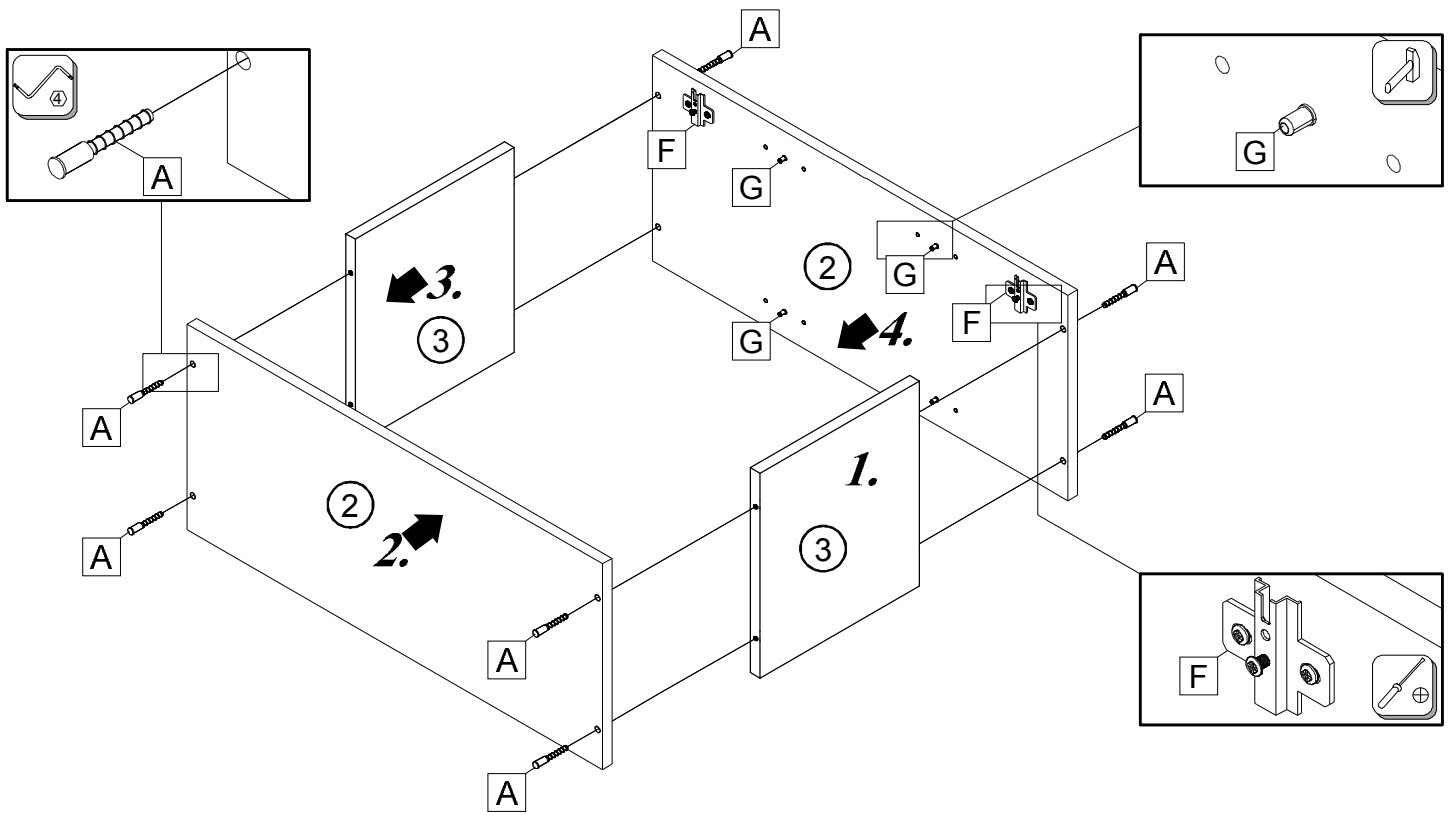

	A 8x		G 8x		F 2x
--	------	---	------	---	------



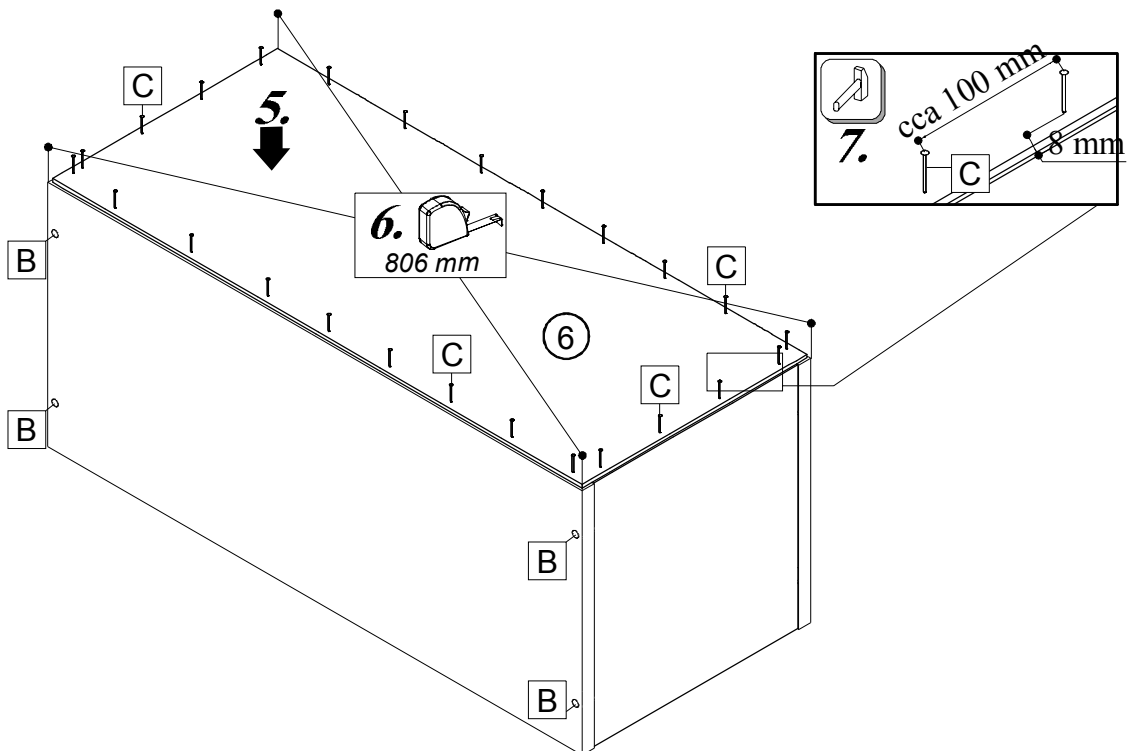

	Ø1,6x20		B 8x
C 20x		B 8x	

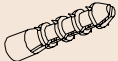

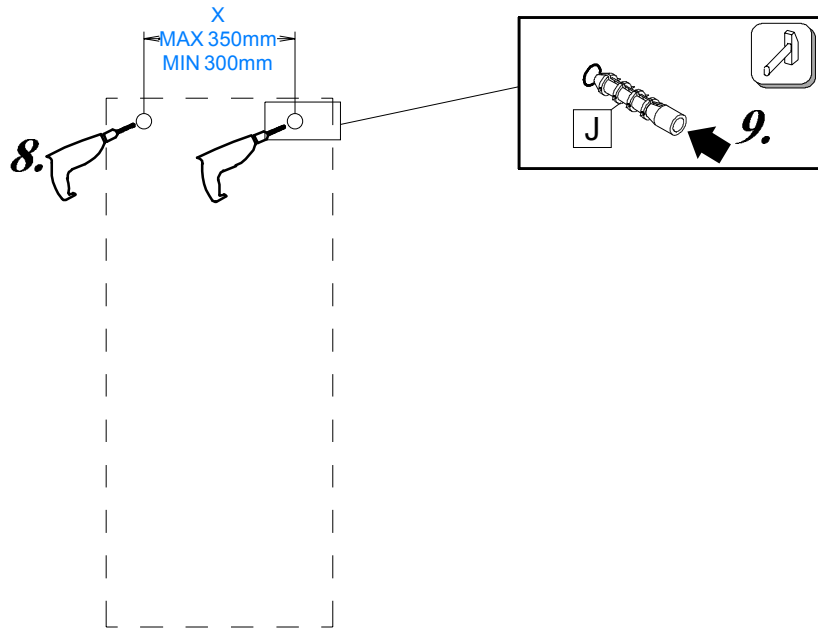



J   2x

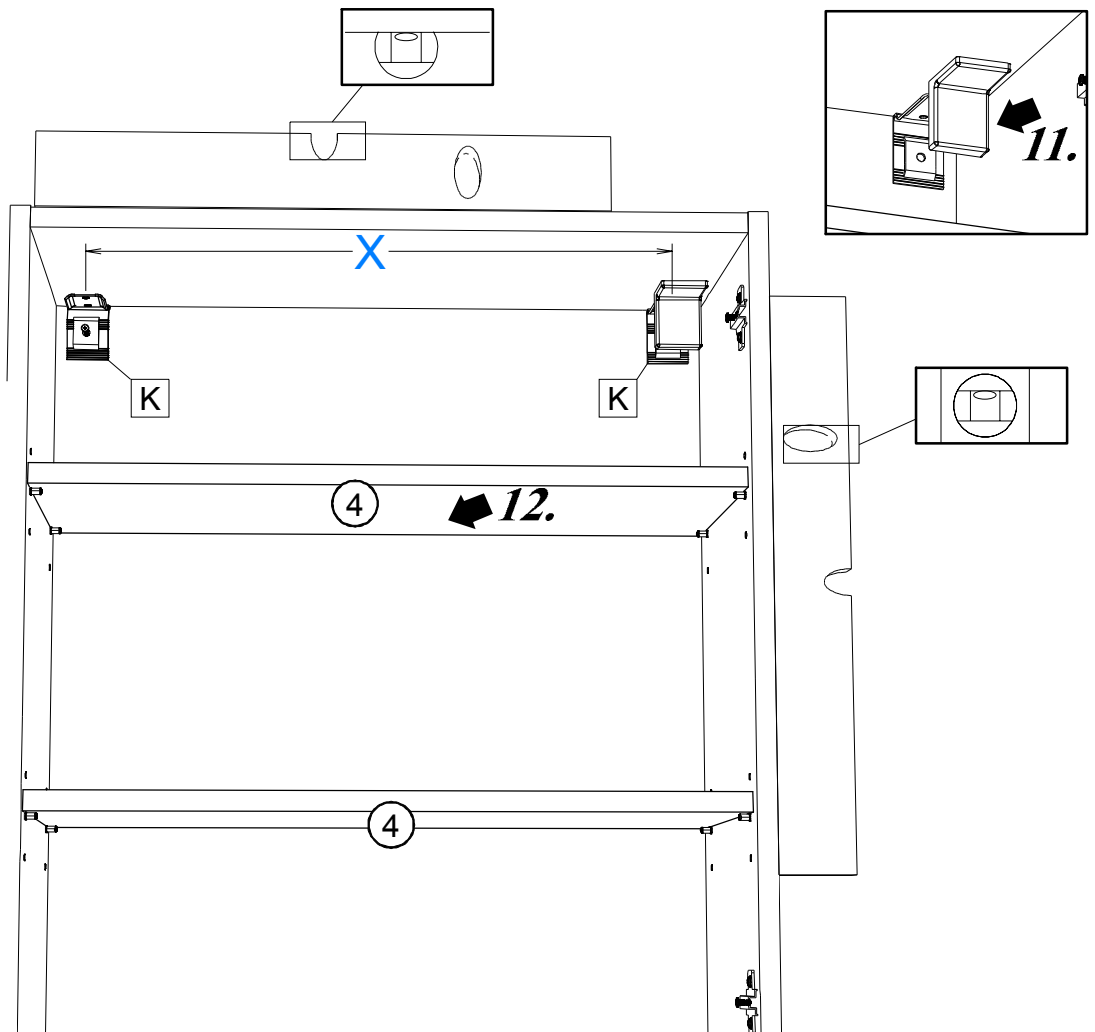
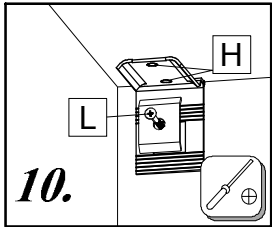

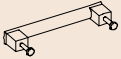
		
Ø3,5x15		Ø5x50
H   4x	K   2x	L   2x



		
D 1x	E 2x	H 4x
Ø3,5x15		

