

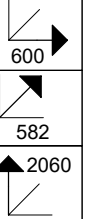

NOPL  
**NOPL-081-60**

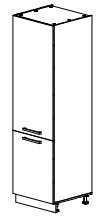

V PRÍPADE REKLAMÁCIE JE POTREBNÉ NAHLÁSIŤ  
 VÝROBNÉ ČÍSLO VIDITEĽNÉ NA ETIKETE



A 6x	B 12x	C 5x	D 5x	E 10x	F 2x	G 16x	H 2x	J 24x	K 25x



L 4x	M 4x	N 4x	P 12x	R 12x

0h 55min			Ø5	3m	4		≤ 0,5 kg

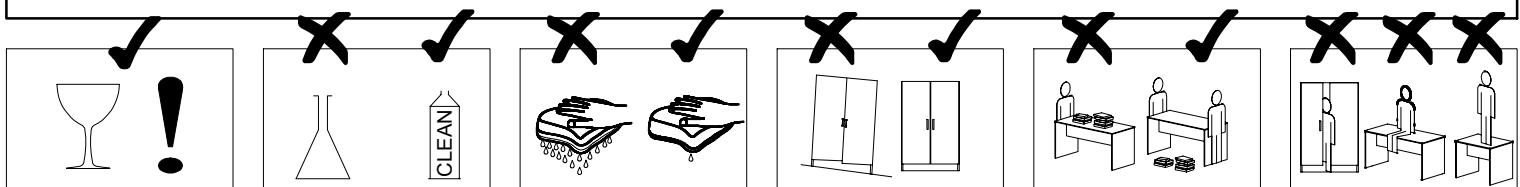
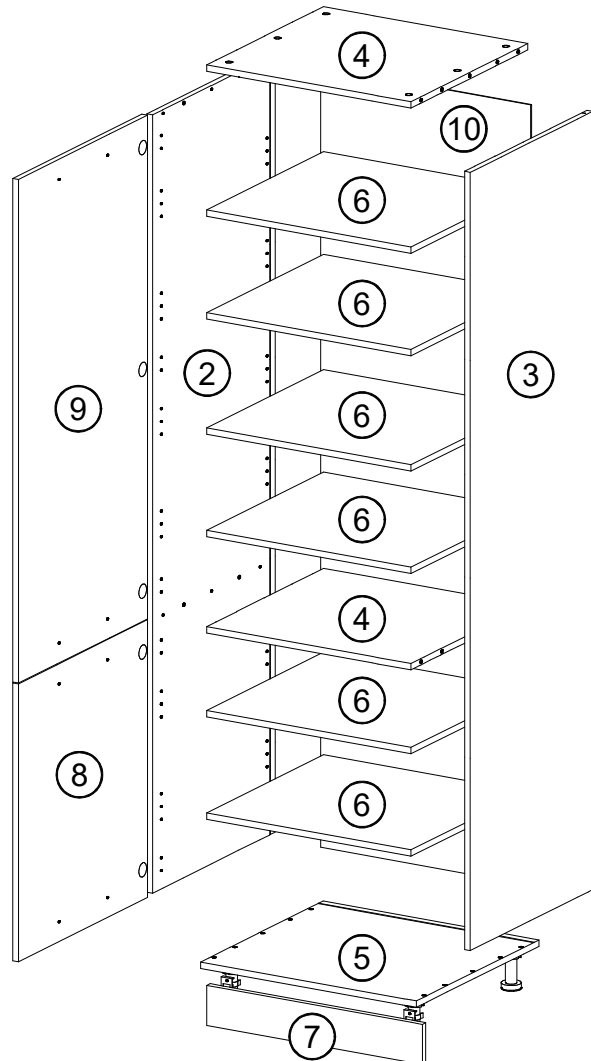

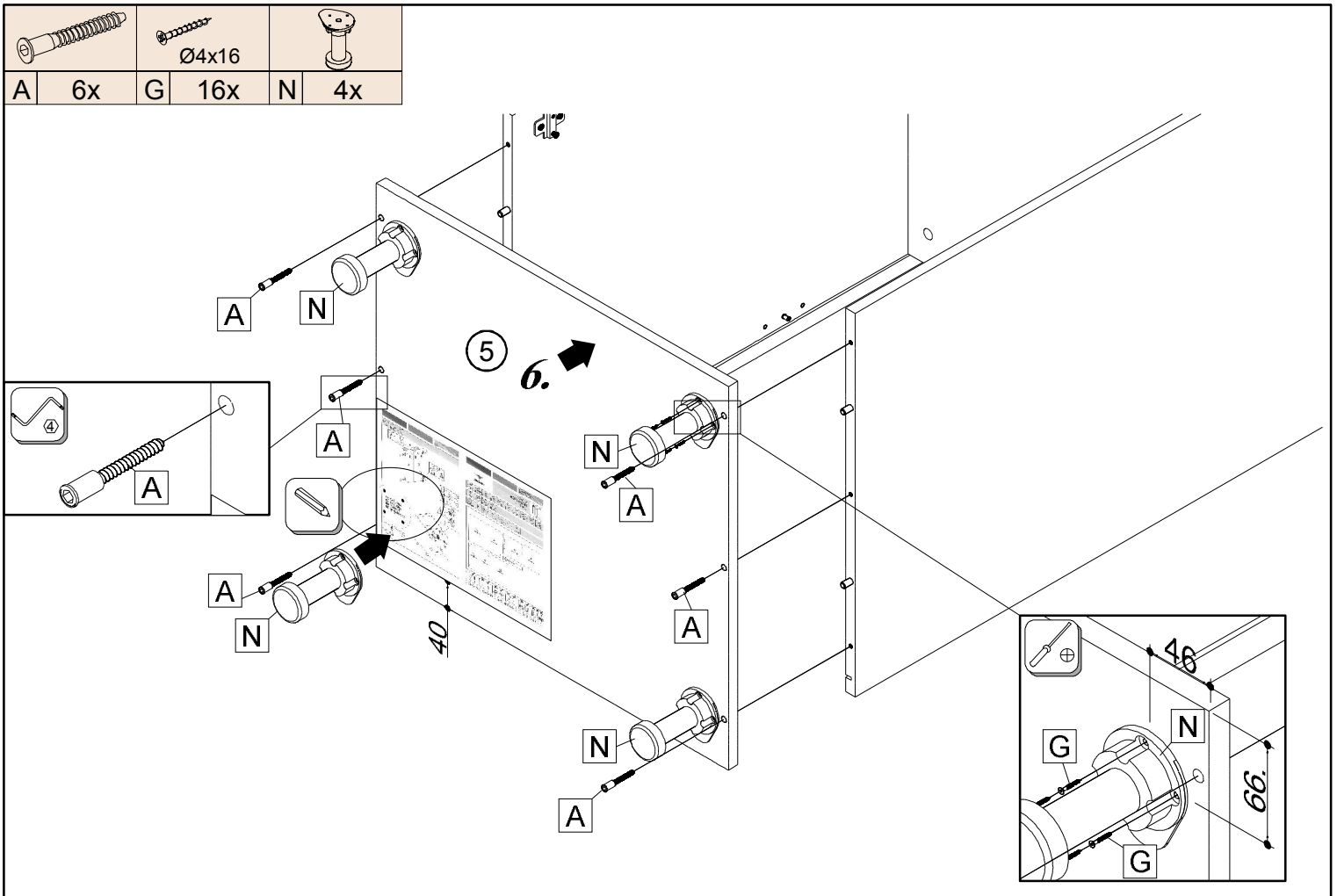
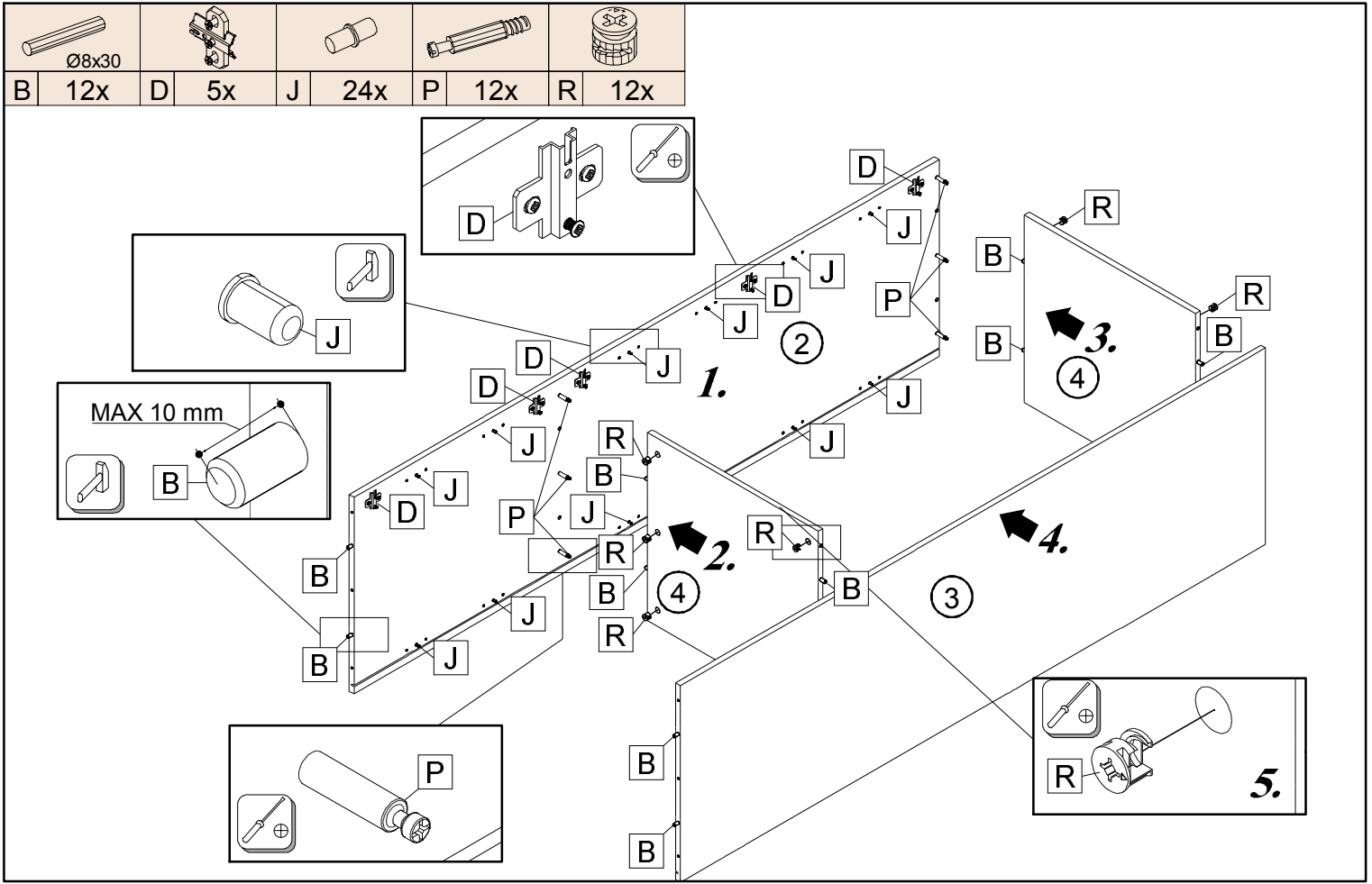
ID	ID	Part	Qty	Order
00423	②	1944*566*16	1x	1/3
00424	③	1944*566*16	1x	1/3
04900	④	568*540*16	2x	2/3
04901	⑤	600*566*16	1x	2/3
04902	⑥	568*540*16	6x	2/3 3/3
00401	⑦	600*100*16	1x	2/3
00434	⑧	694*596*16	1x	3/3
00435	⑨	1258*596*16	1x	3/3
04904	⑩	1949*584*2,5	1x	3/3



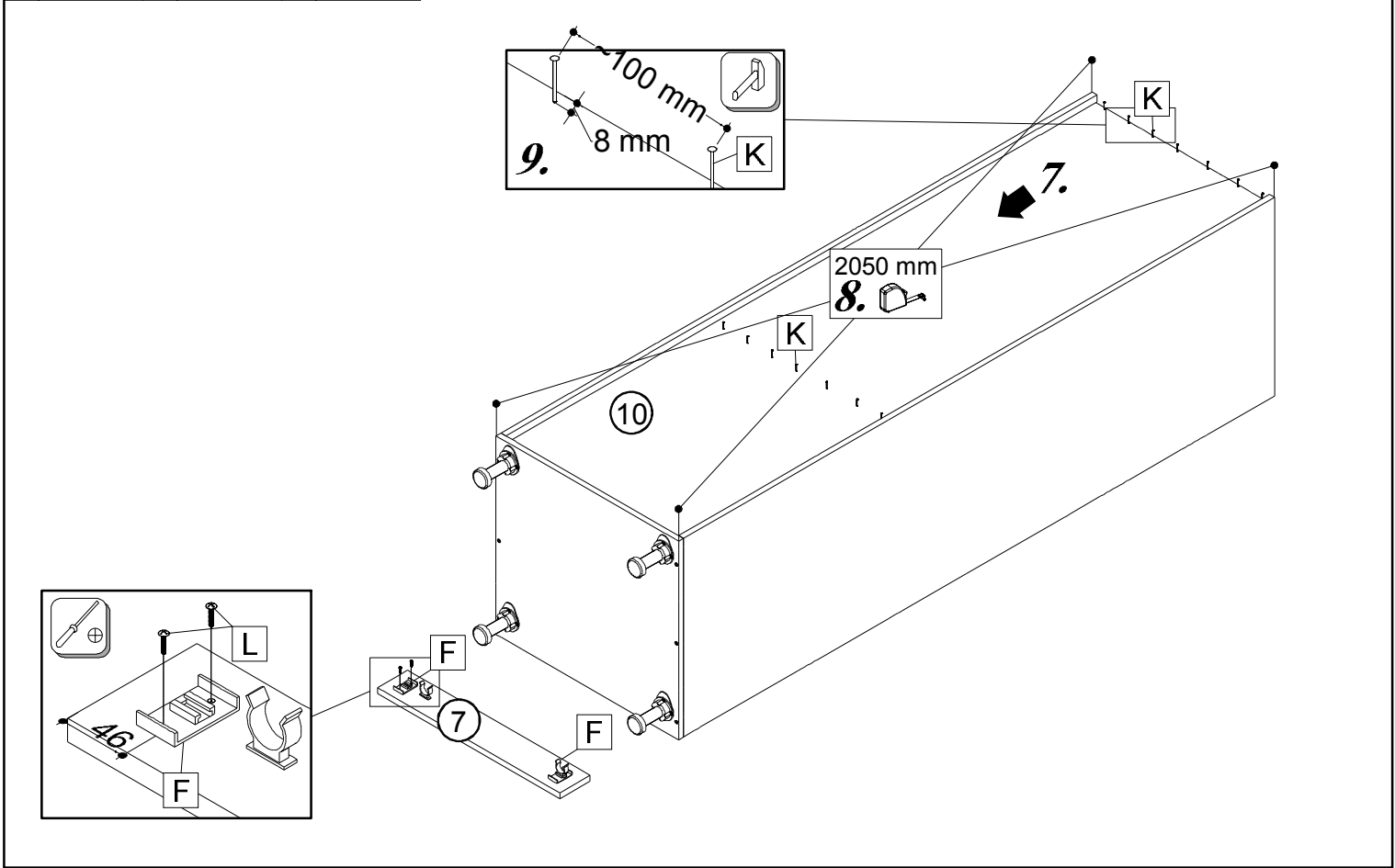

		
F 2x	K 25x	L 4x



	
C 5x	E 10x

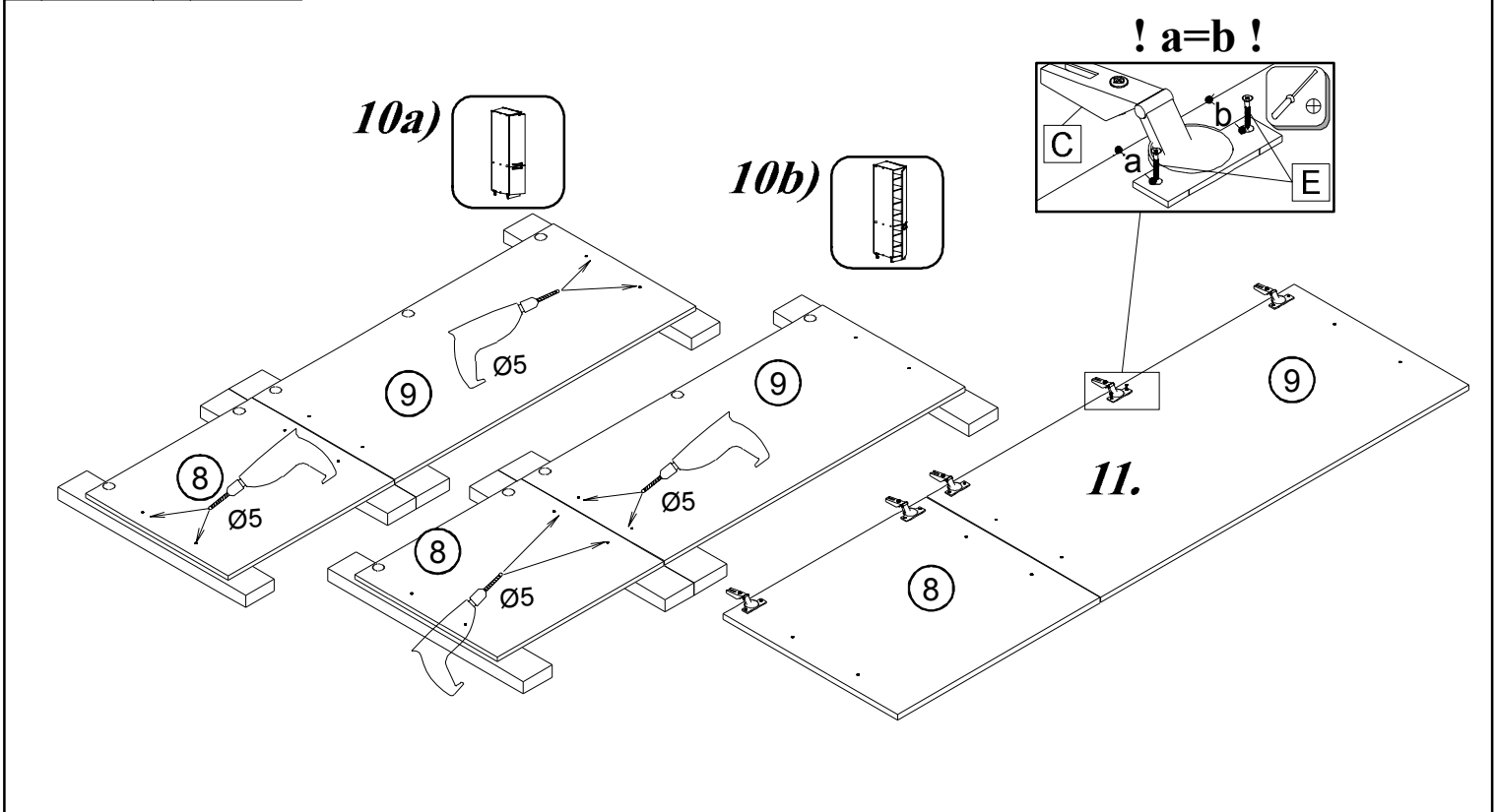

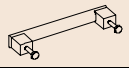

H 2x

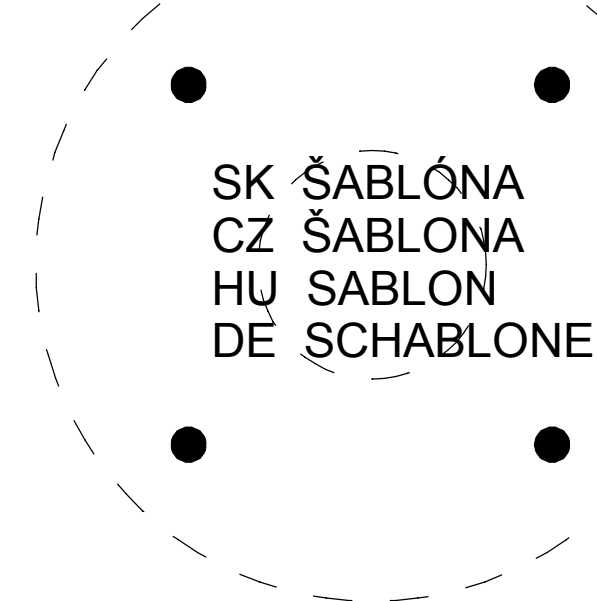
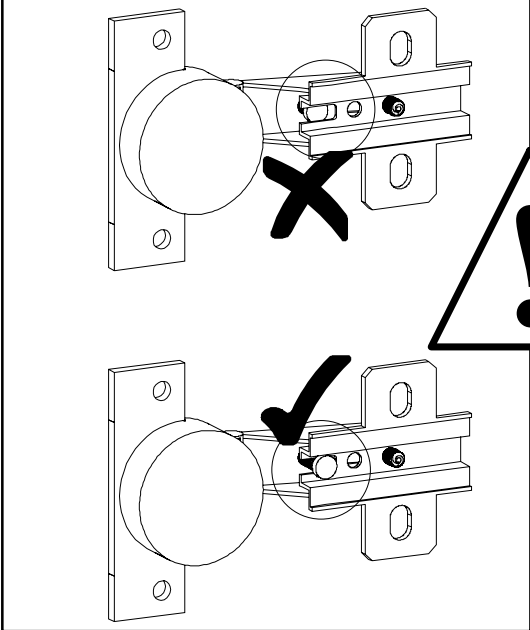
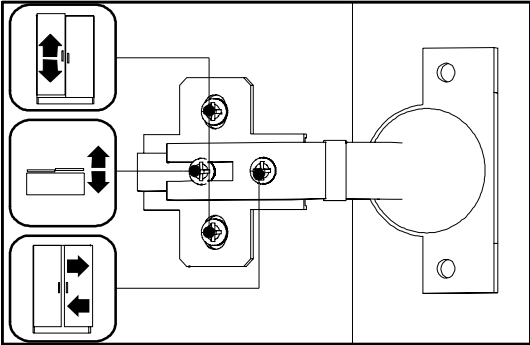

SK ŠABLÓNÁ  
CZ ŠABLONA  
HU SABLON  
DE SCHABLONE

