

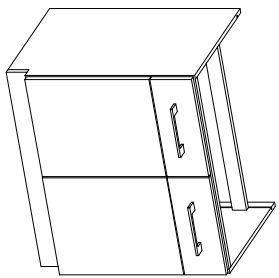











80 ZL 2F BB



| | | | | | | | | | | | | | | | | | | | | | | | |
|---|-----|---|-----|---|---|--|---|---|-----|---|----|---|---|---|---|---|----|---|----|---|----|---|----|
|  | B |  | E1 |  | A |  | O |  | S15 |  | R2 |  | G |  | H |  | P5 |  | F2 |  | P4 |  | E9 |
| 8 | 8 | 8 | 1 | 2 | 4 | 4 | 4 | 16 | 4 | 2 | 2 | 2 | 2 | 2 | 2 | 2 | 2 | 2 | 2 | 2 | 2 | 2 | 2 |
|  | K28 |  | K29 | | | | | | | | | | | | | | | | | | | | |
| 4 | 4 | 2 | 2 | | | | | | | | | | | | | | | | | | | | |

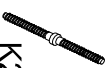
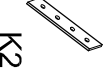
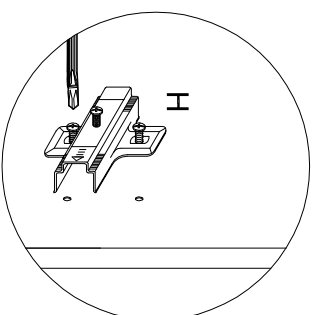
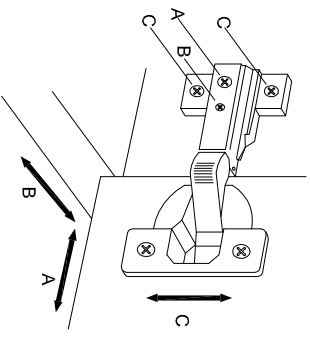
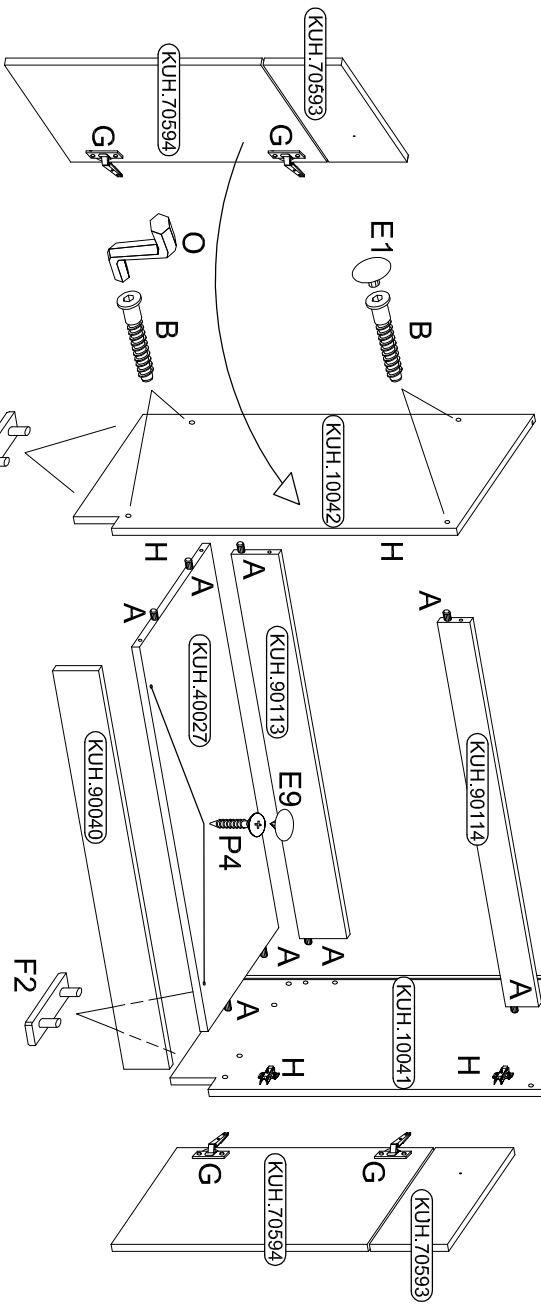
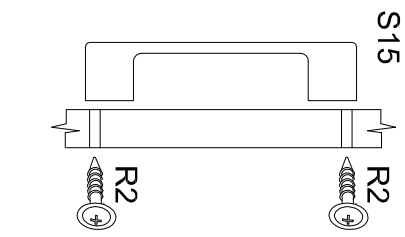
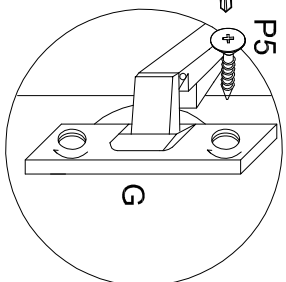
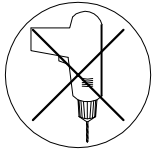

ISM-KUH-00765

80 ZL 2F BB

