

# LOUNGE CHAIR

---

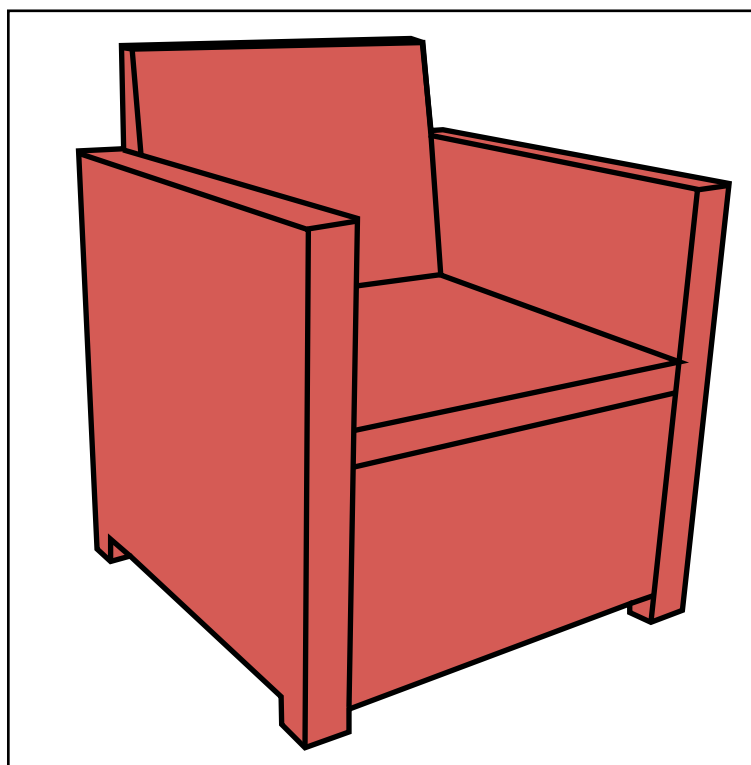
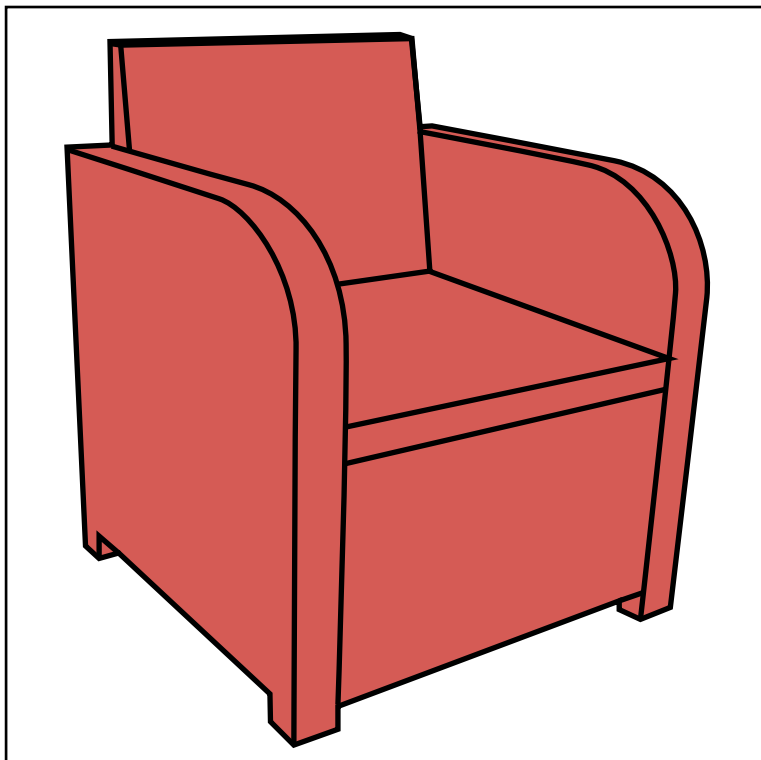

**ALLiBERT** 

P.O.Box 224 | 5120 AE Rijen | The Netherlands | [www.allibert-outdoor.com](http://www.allibert-outdoor.com)



NEN 581

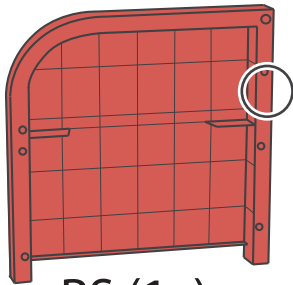
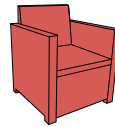
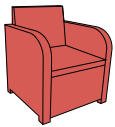

RS (1x)

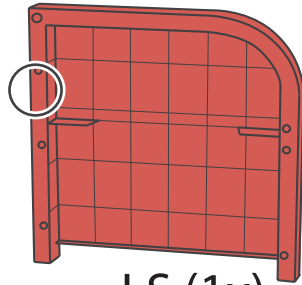

LS (1x)

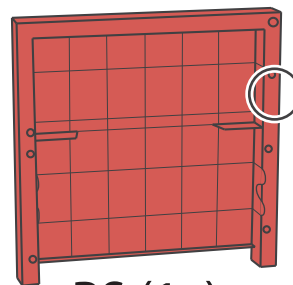

RS (1x)

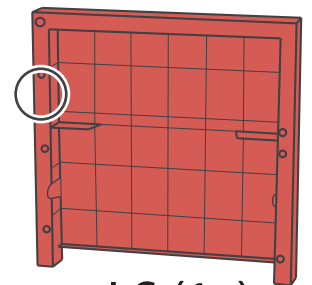

LS (1x)

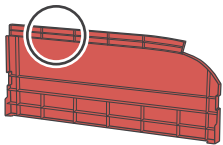

SCR (1x)

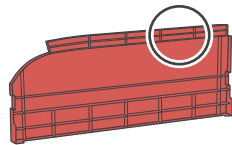

SCL (1x)

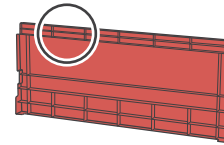

SC (2x)

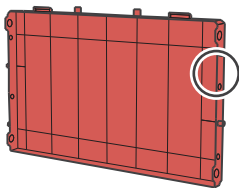

F1 (1x)

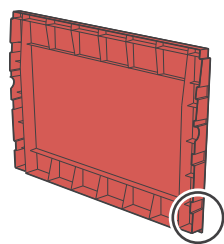

BC1 (1x)

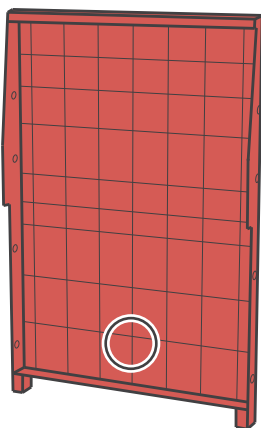

B1 (1x)

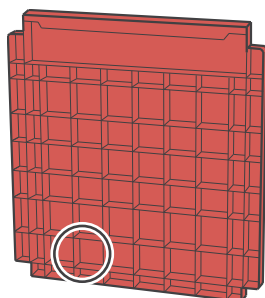

S1 (1x)

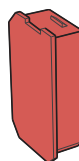

NA (2x)

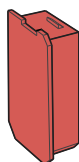

NB (2x)

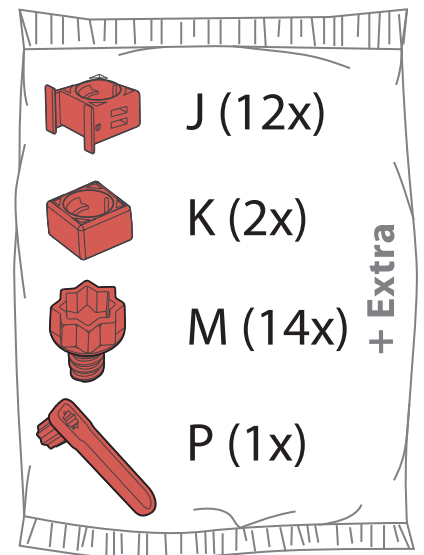

J (12x)

K (2x)

M (14x)

P (1x)

+ Extra

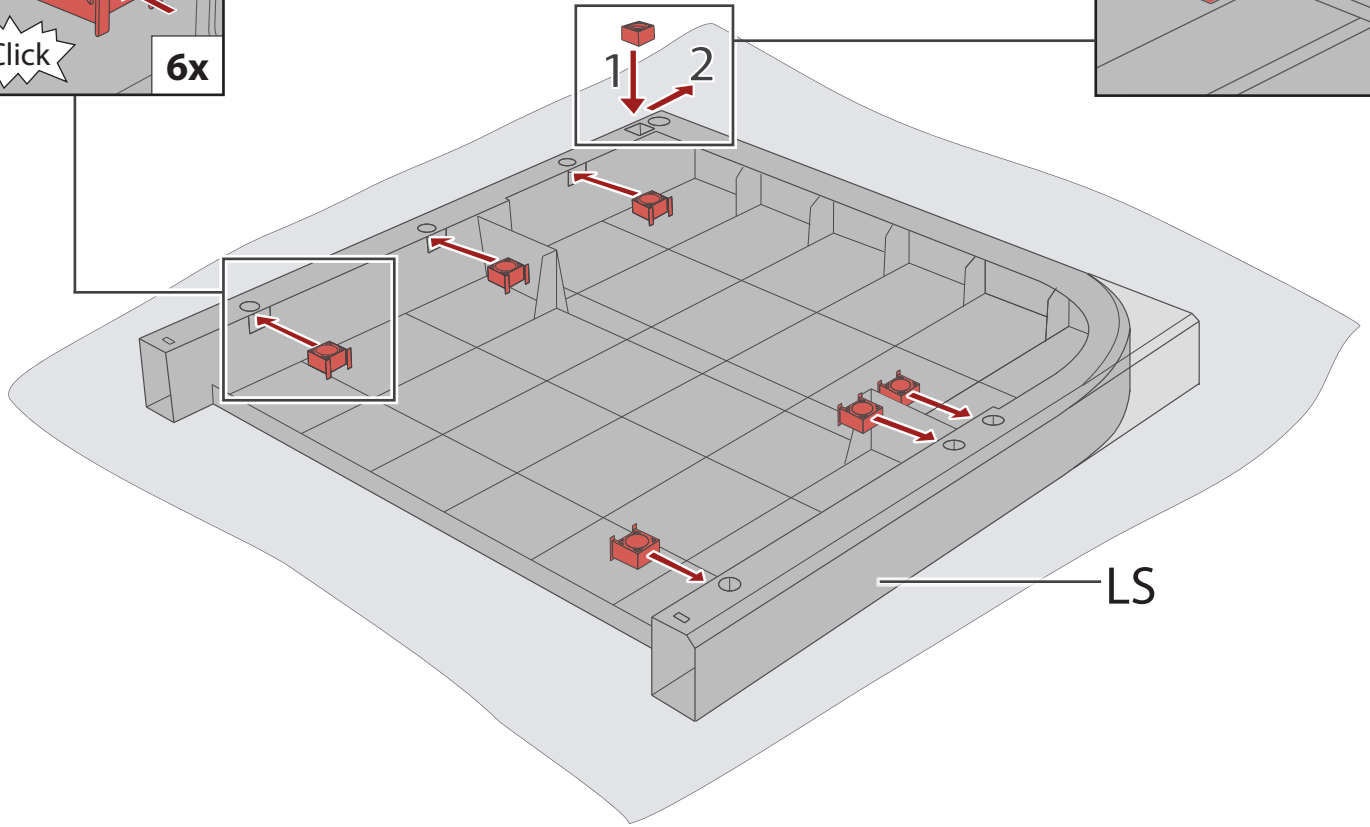
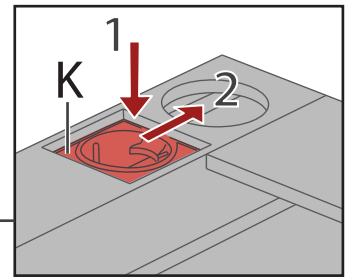
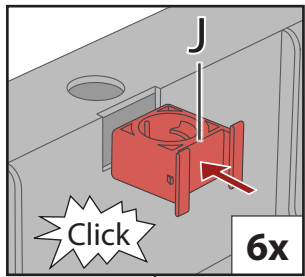

1

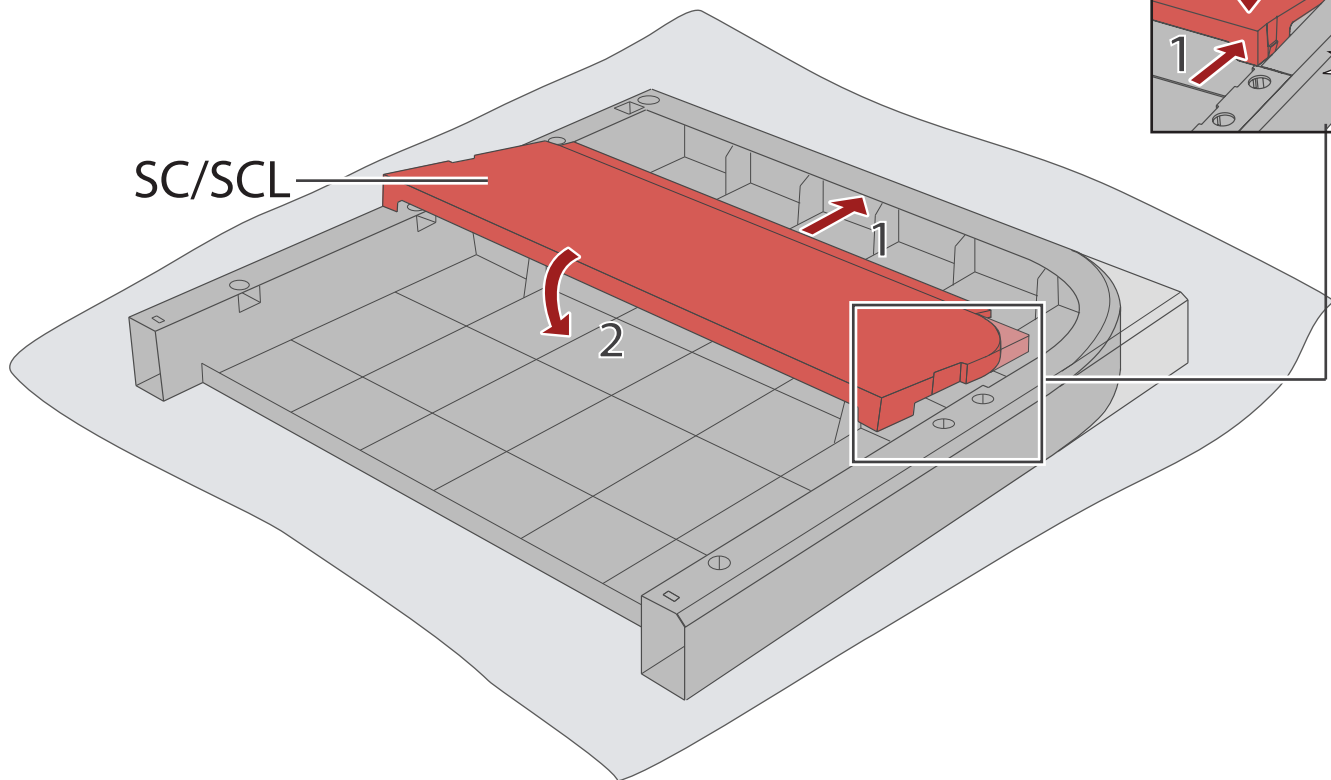
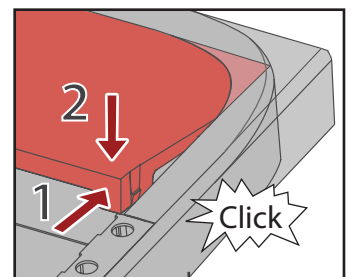

2

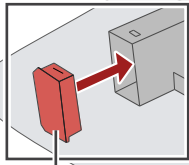
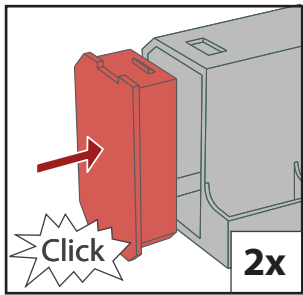

NA



NB

3

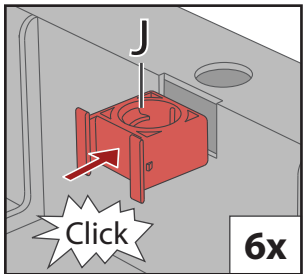

Click

6x

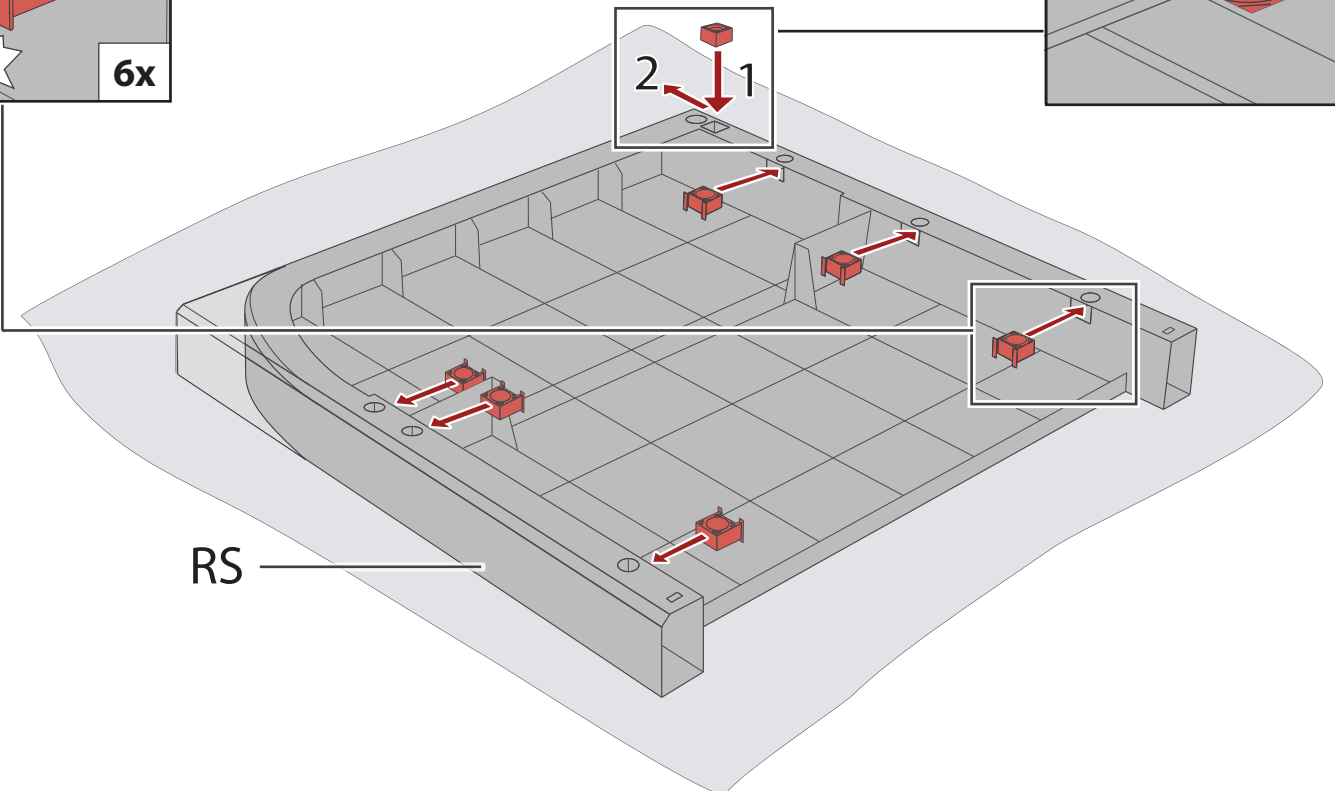

RS

4

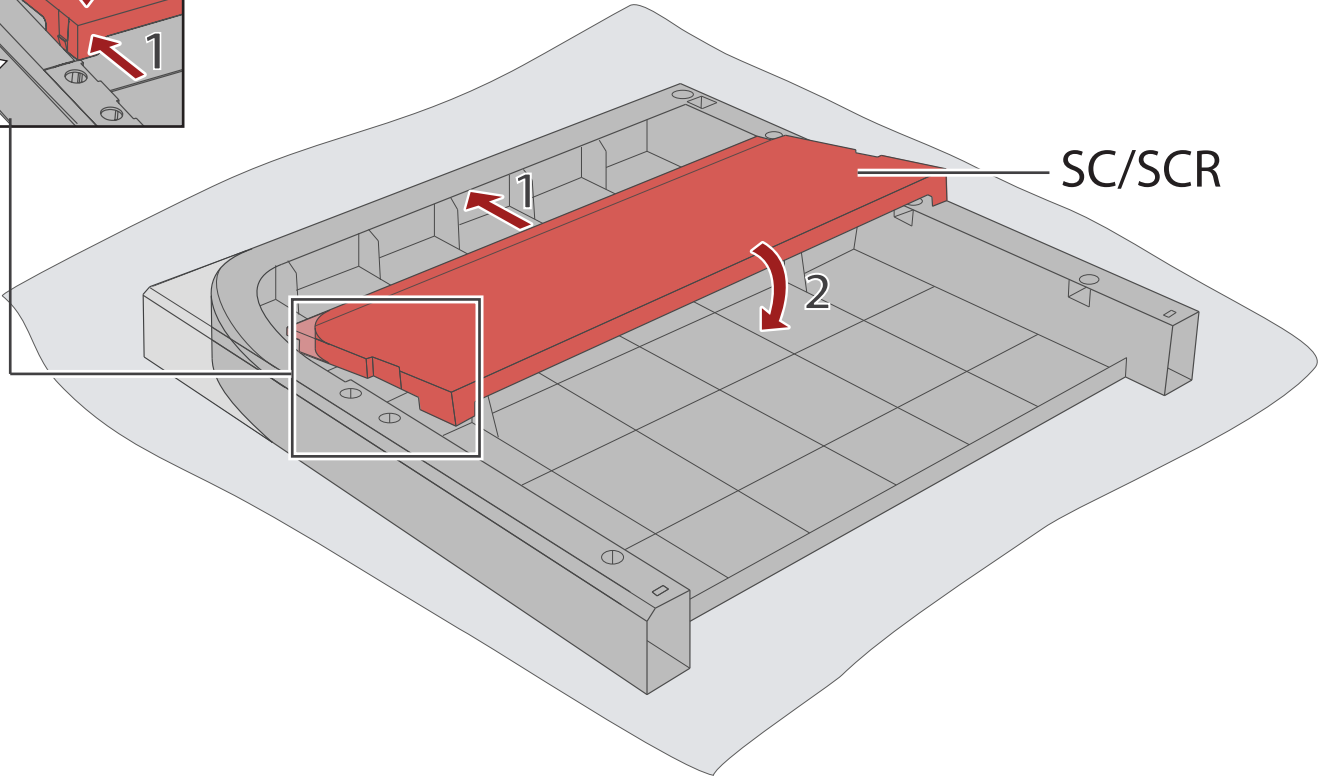
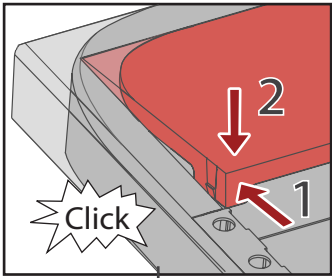

5

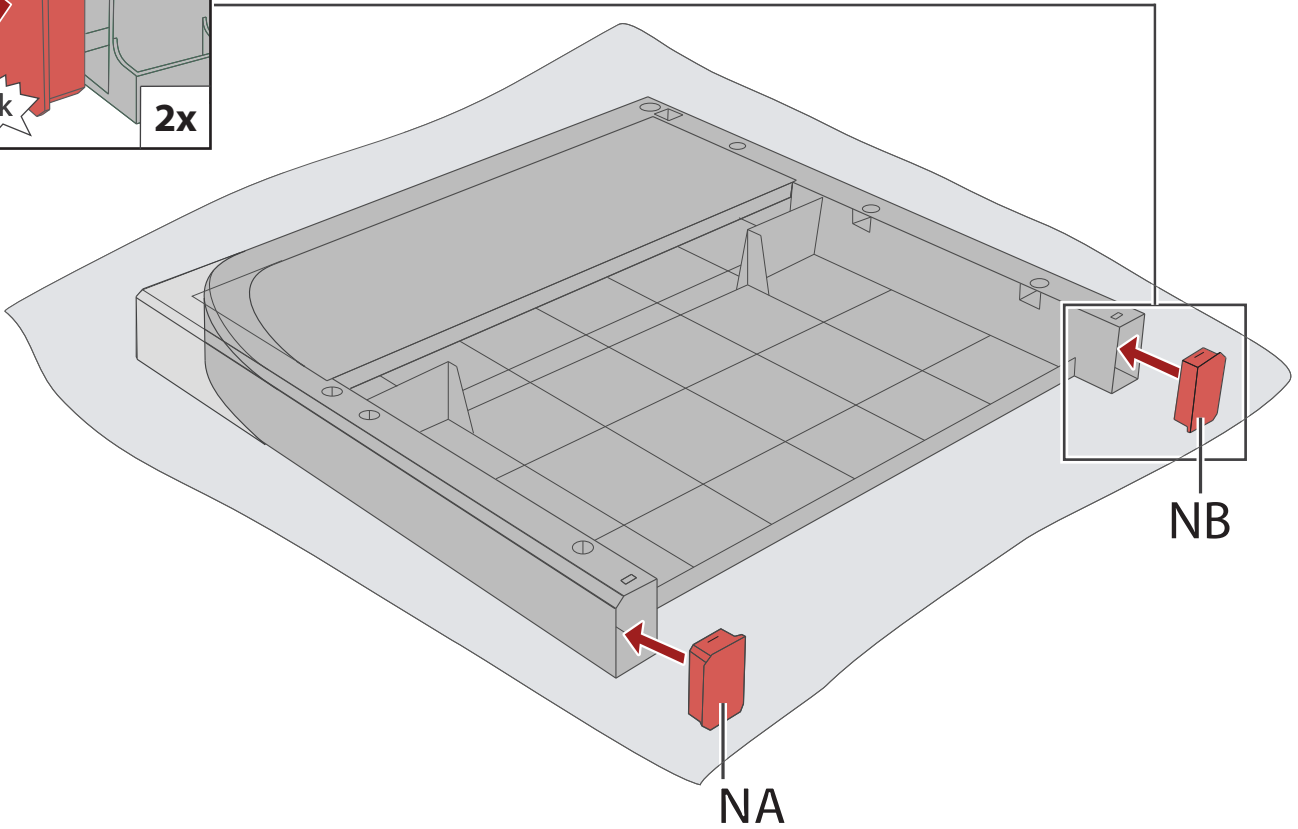
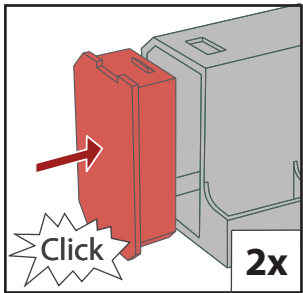

6

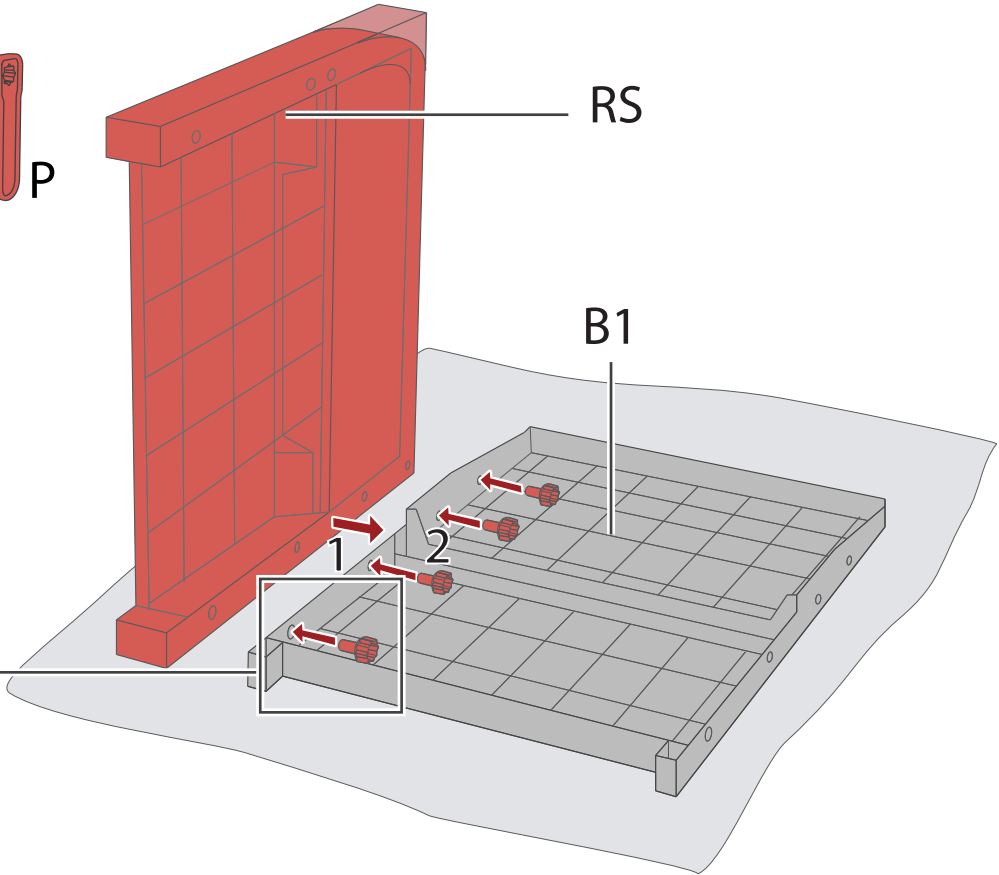
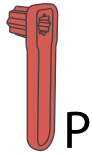
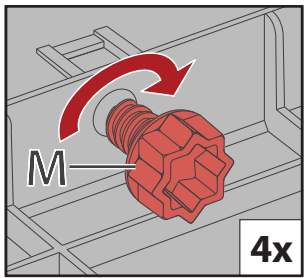

7

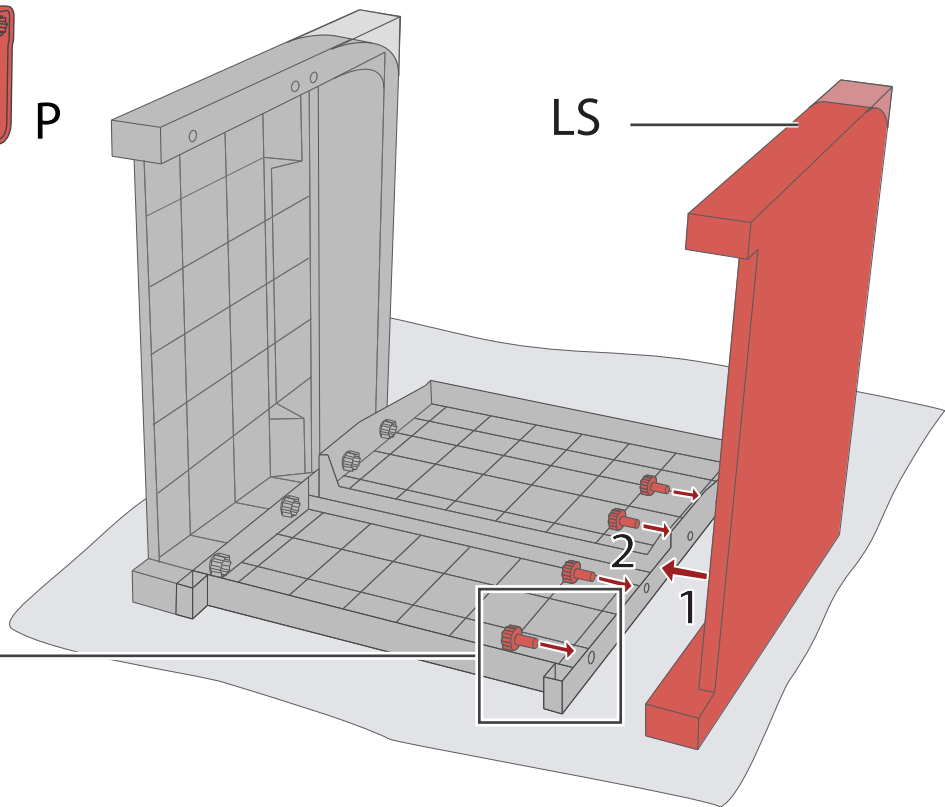
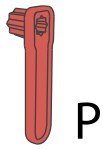
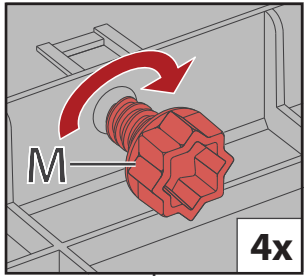

8

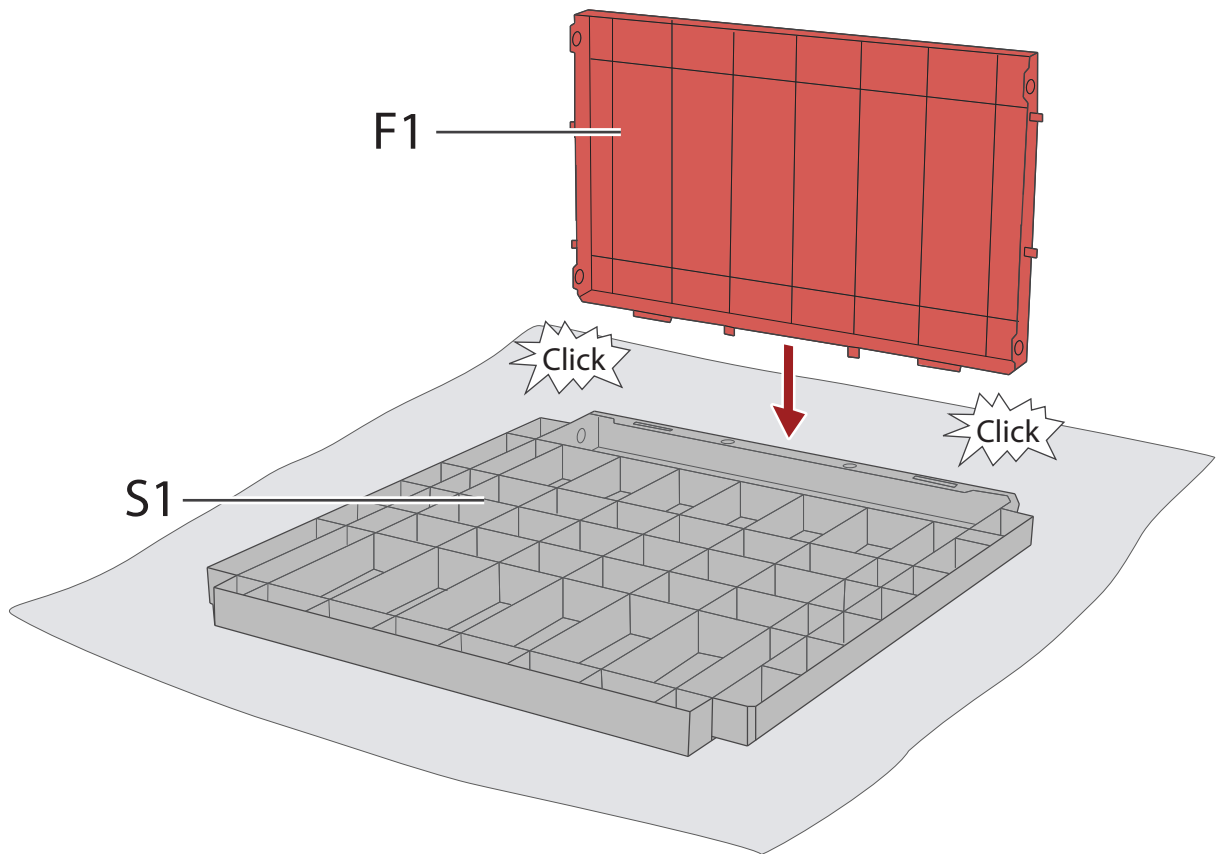

9

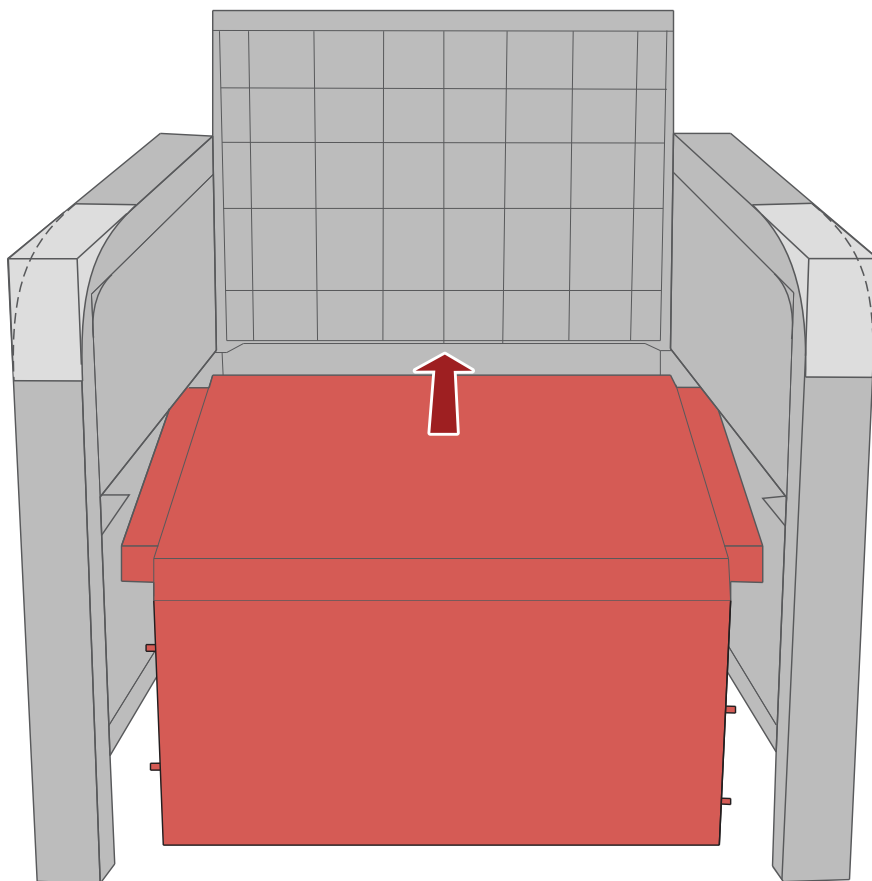

10

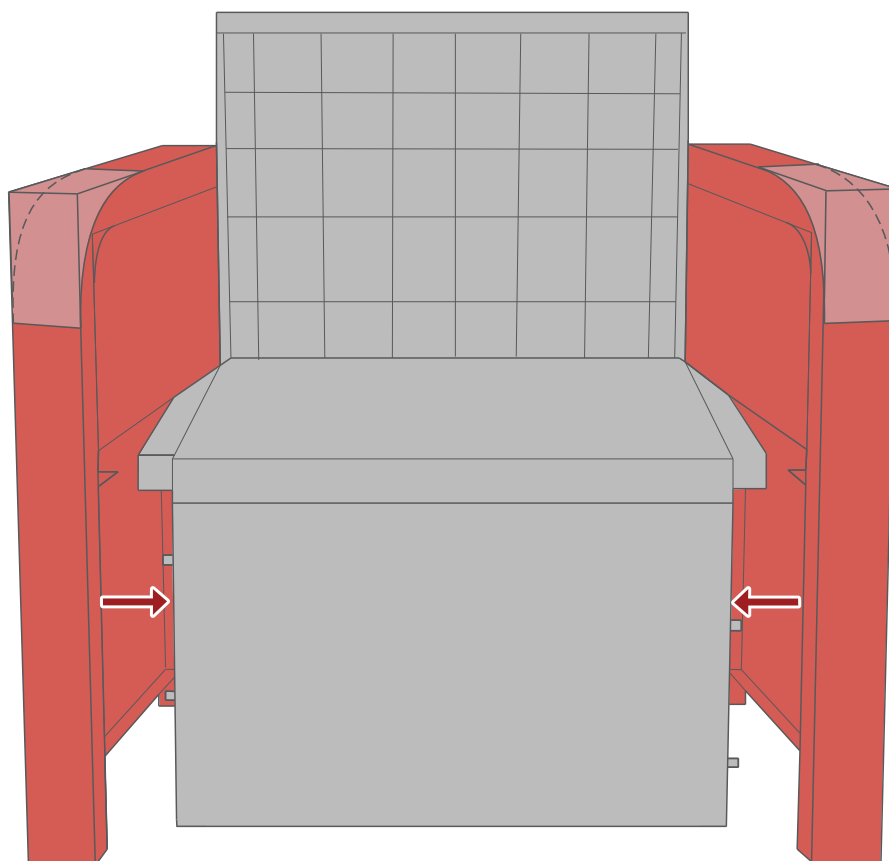

11

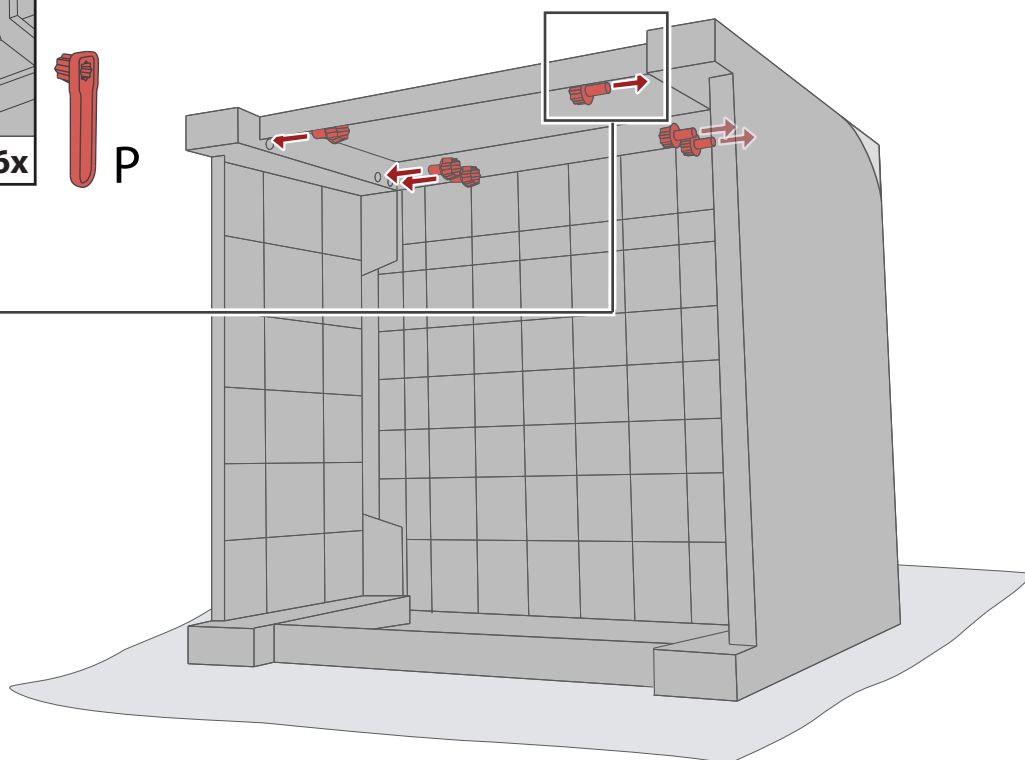
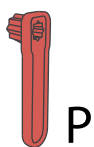
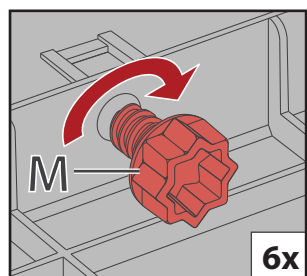

12



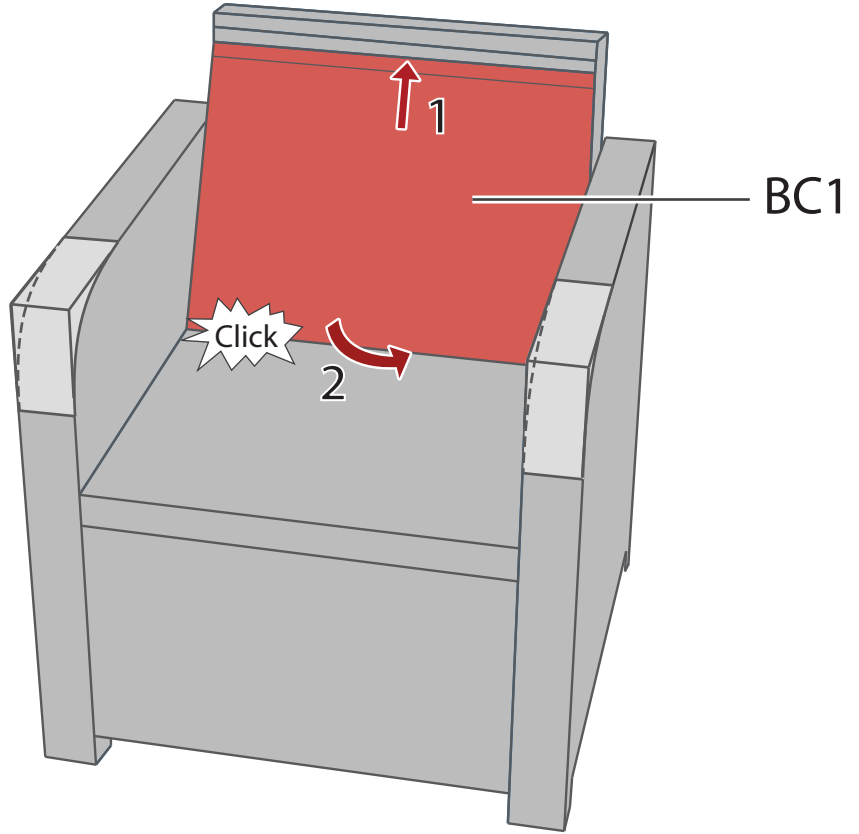
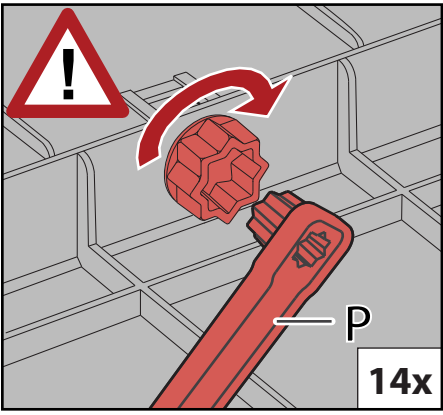

13

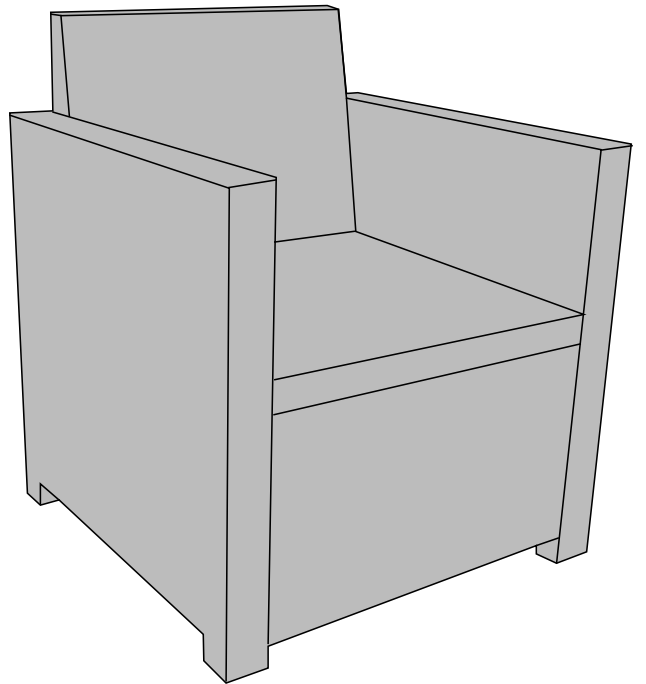
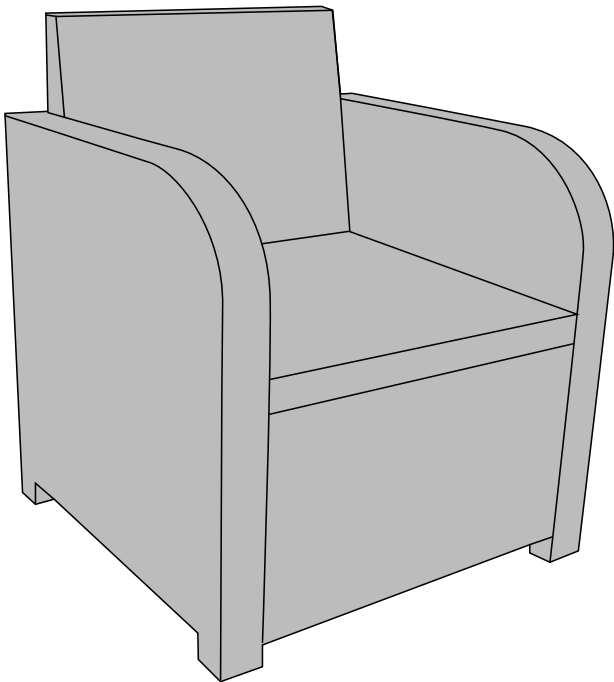

14