

IDEA

SOUPACKOVÁ SKRINKA
SE ZASUVKAMI

1503

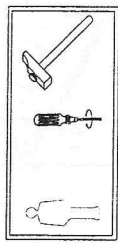

8x



40x



6x

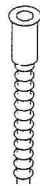

9x

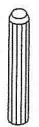

4x



6x

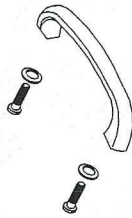

4x



4x



1x

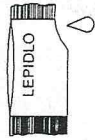

8x



8x



1.)

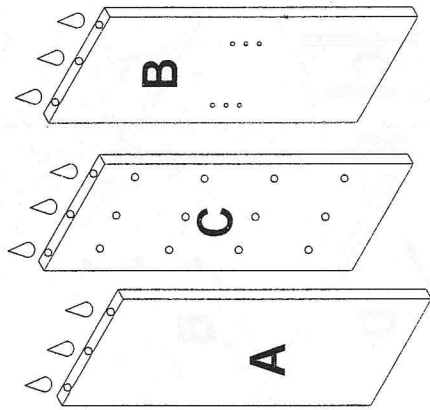
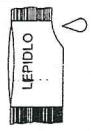

2.)

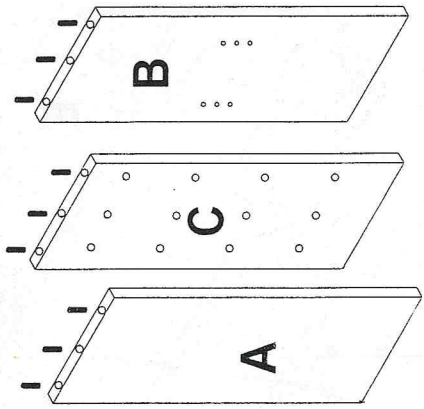
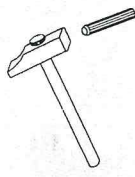

3.)

8x

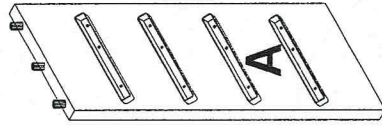

4.)

4x

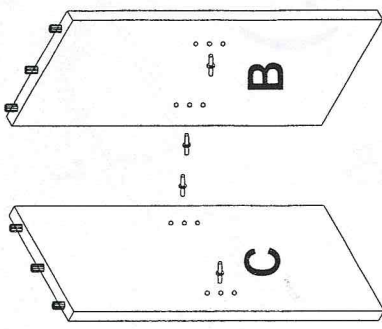

5.)

4x

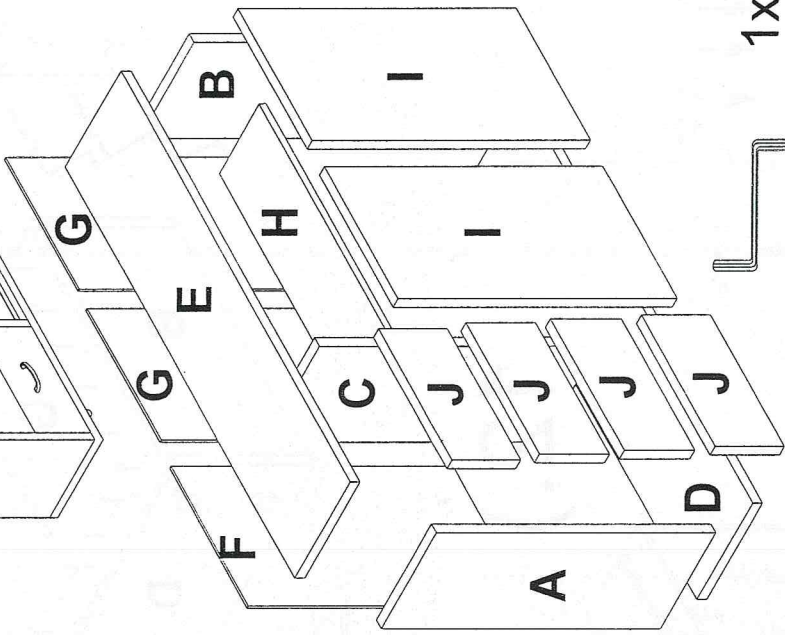
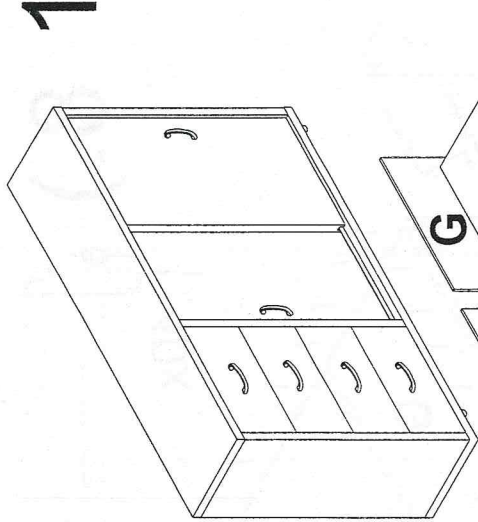
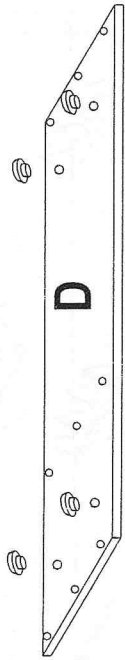

1x



1x

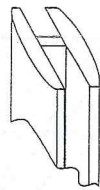

1x

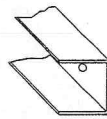

a

8x





1x

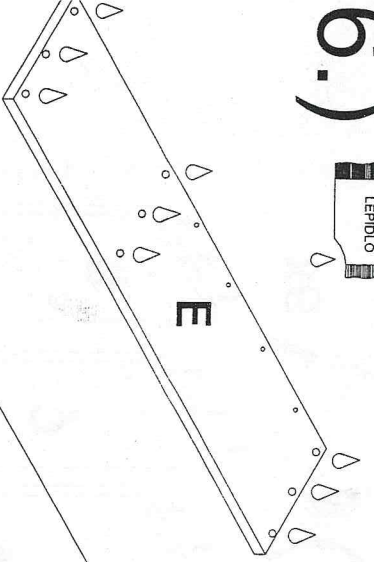

b

6.) 



7.)  9x

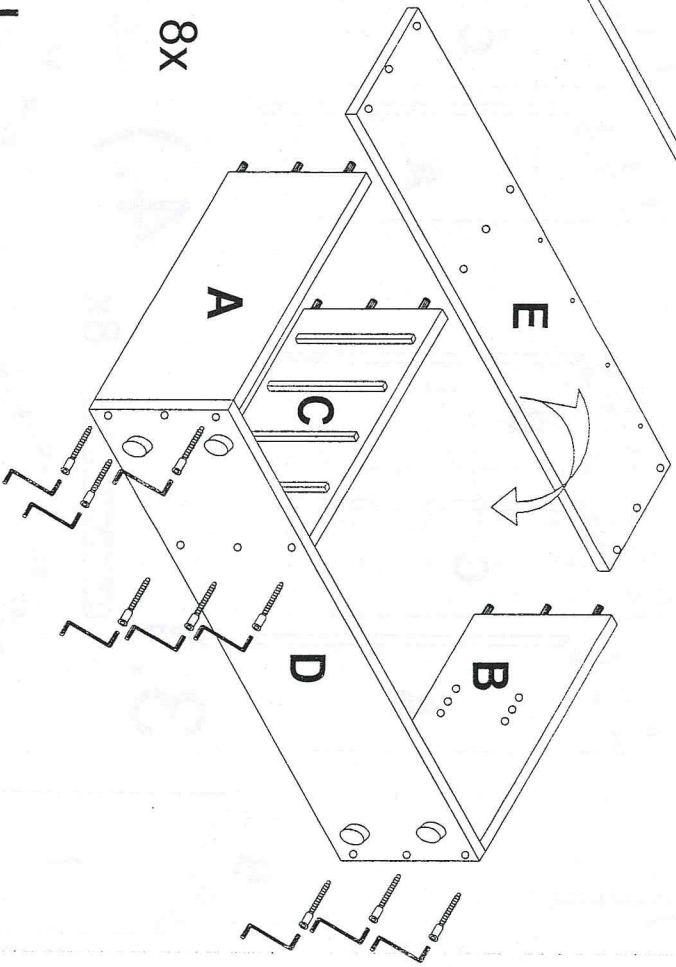

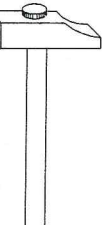
8.)  40x

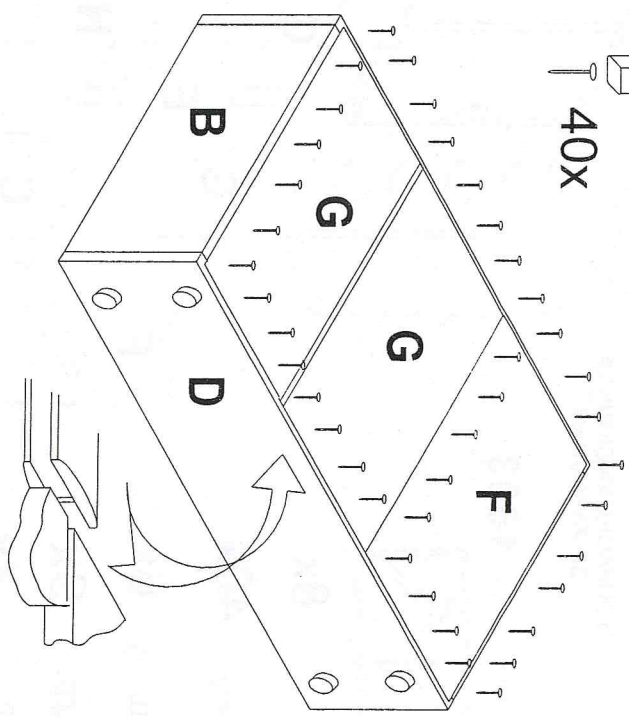

9.)  8x

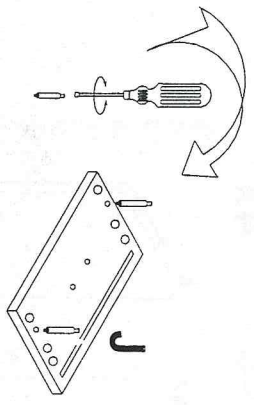

10.)

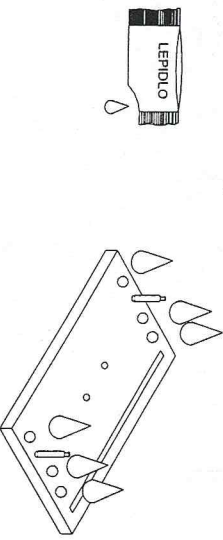

11.)

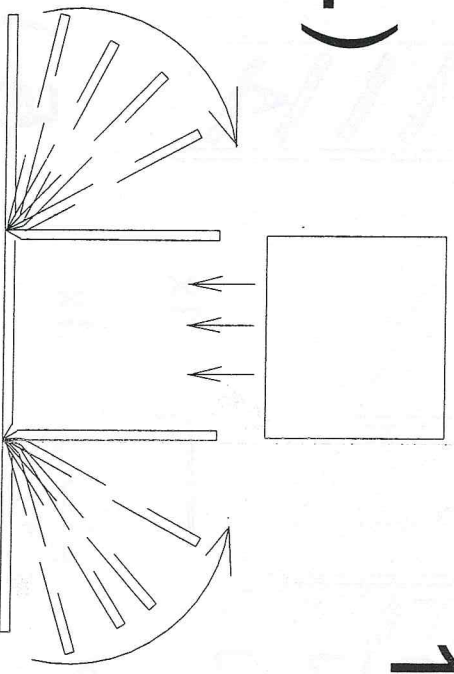

12.)

