

IDEA 61535
21535
11535

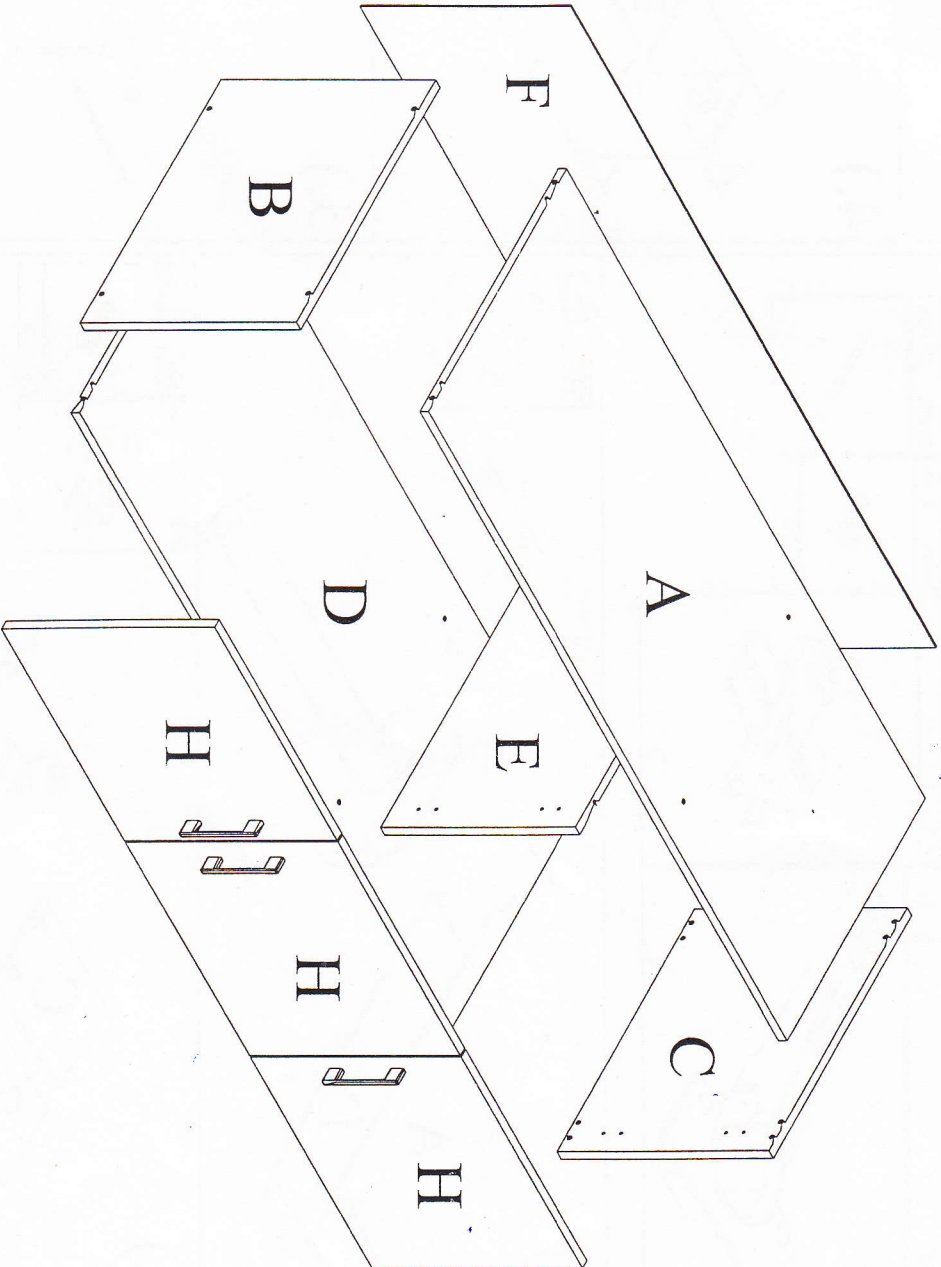

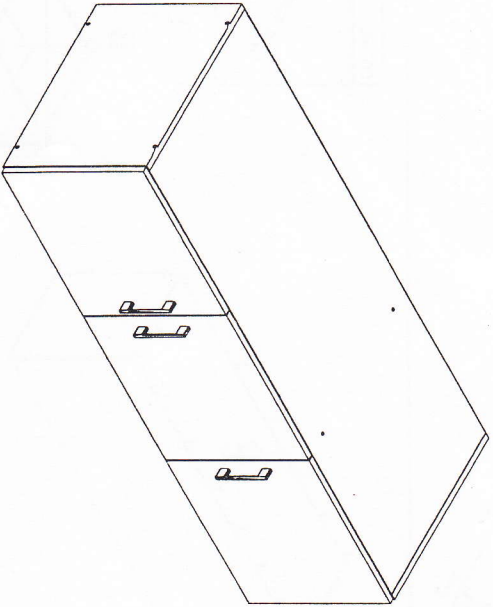
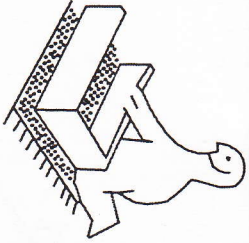
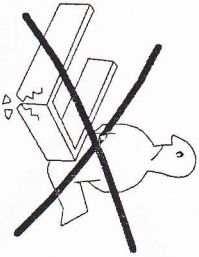
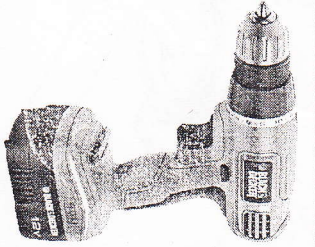
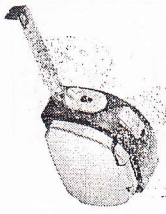

| | | | | | | | | | | | |
|-------|----|-------|-----|-------|-----|-------|------|-------|----|-------|----|
| 0013K | 1x | 0005V | 12x | 0008K | 10x | 0001K | 8x | 0004V | 6x | 0017U | 3x |
| | | | | | | | | | | | |
| | | 7x50 | | | | | 8x40 | 4x30 | | | |
| 0015K | 6x | 0014K | | 0001V | 24x | 0016K | 40x | | | | |
| | | | | | | | | | | | |

1.)

| | |
|-------|------|
| 0001K | 8x |
| | 8x40 |

2.)

| | | | |
|-------|----|-------|------|
| 0014K | 6x | 0001V | 12x |
| | | | 4x16 |

3.)

| | | | |
|-------|----|-------|------|
| 0015K | 6x | 0001V | 12x |
| | | | 4x16 |

4.)

| | |
|-------|----|
| 0013K | 1x |
| | |

| | | | |
|-------|-----|-------|------|
| 0008K | 10x | 0005V | 12x |
| | | | 7x50 |

5.)

| | |
|-------|-----|
| 0016K | 40x |
| | |

6.)

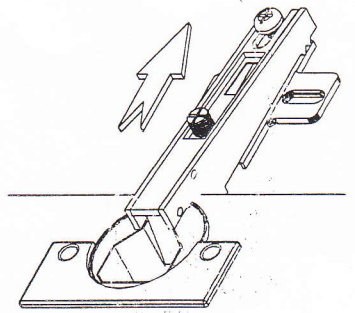
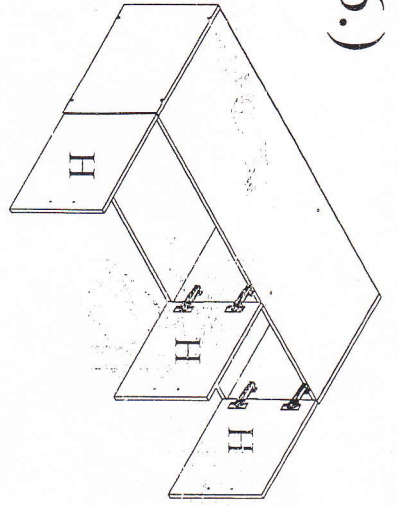

7.)

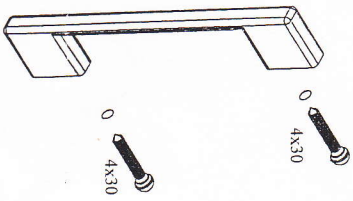
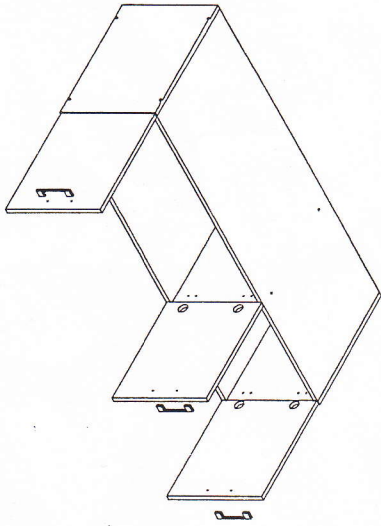

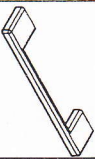
| | | | |
|---|----|--|----|
| 0004V | 6x | 0017U | 3x |
|  4x30 | |  | |

