

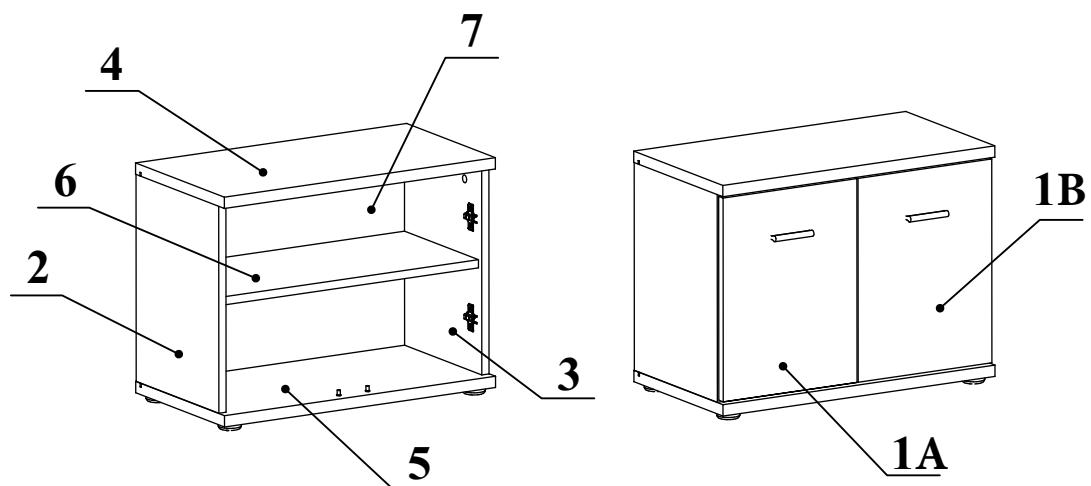

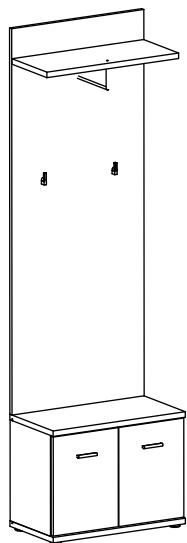

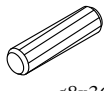



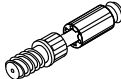

montážny návod Mario

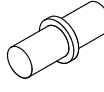
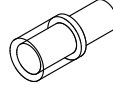
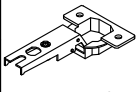
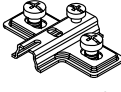
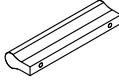
MARIOTYP 3

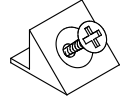
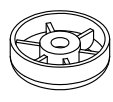

A1 X8  ø8x36	B11 X4  Ø7x50	G4 X4 	B4 X4 	B5 X4  ø15x12	G5 X4 
G7 X4 	G20 X2 	E1 X4  H=0	E2 X4  H=0	K7 X2 	U6 X4  UPØ4x30
Z2 X4  ø5	S4 X6 	I11 X4 	D1 X8  USØ3,5x13	D11 X4  USØ3,5x25	G2 X1 

MARIOTYP 3

1

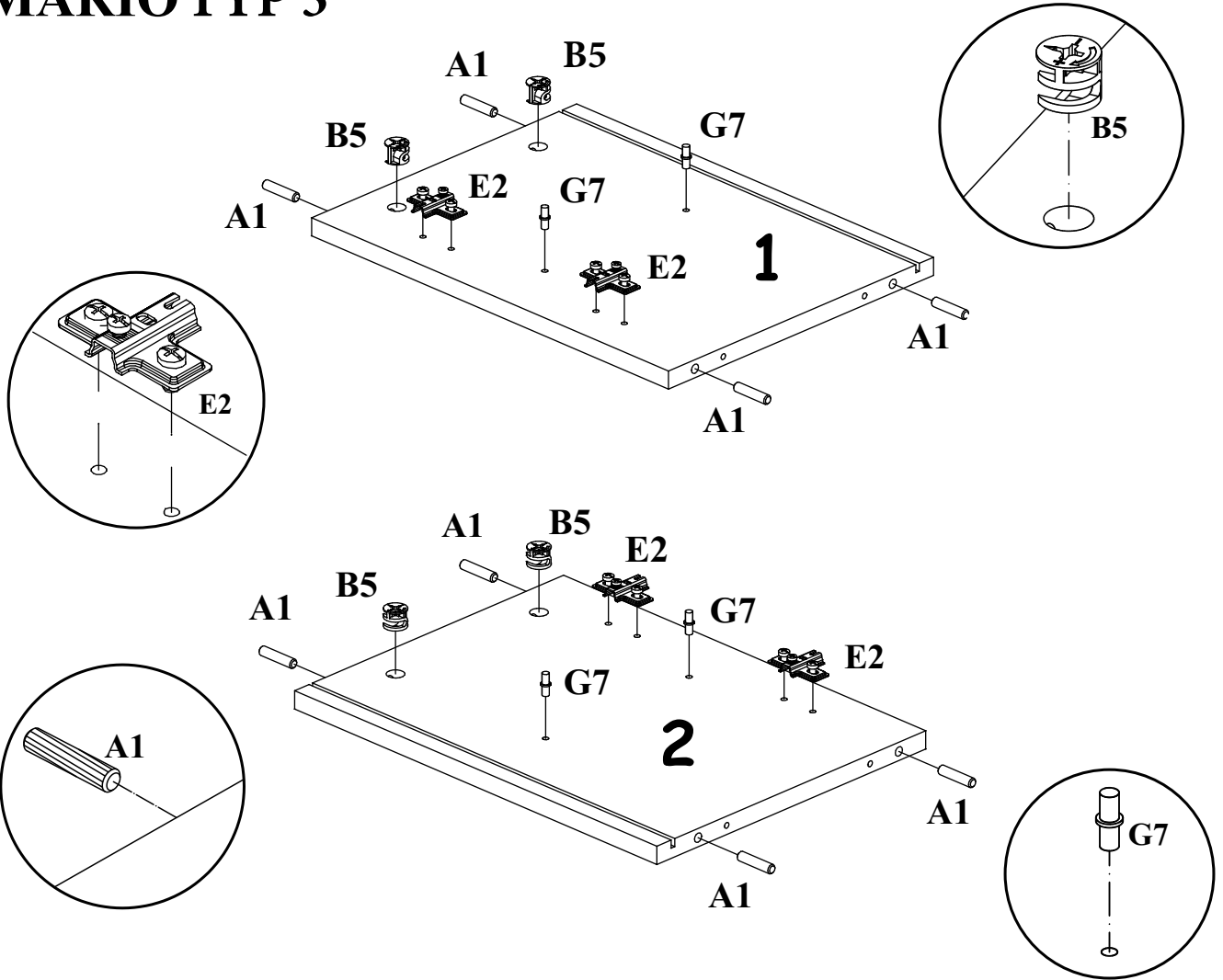

2

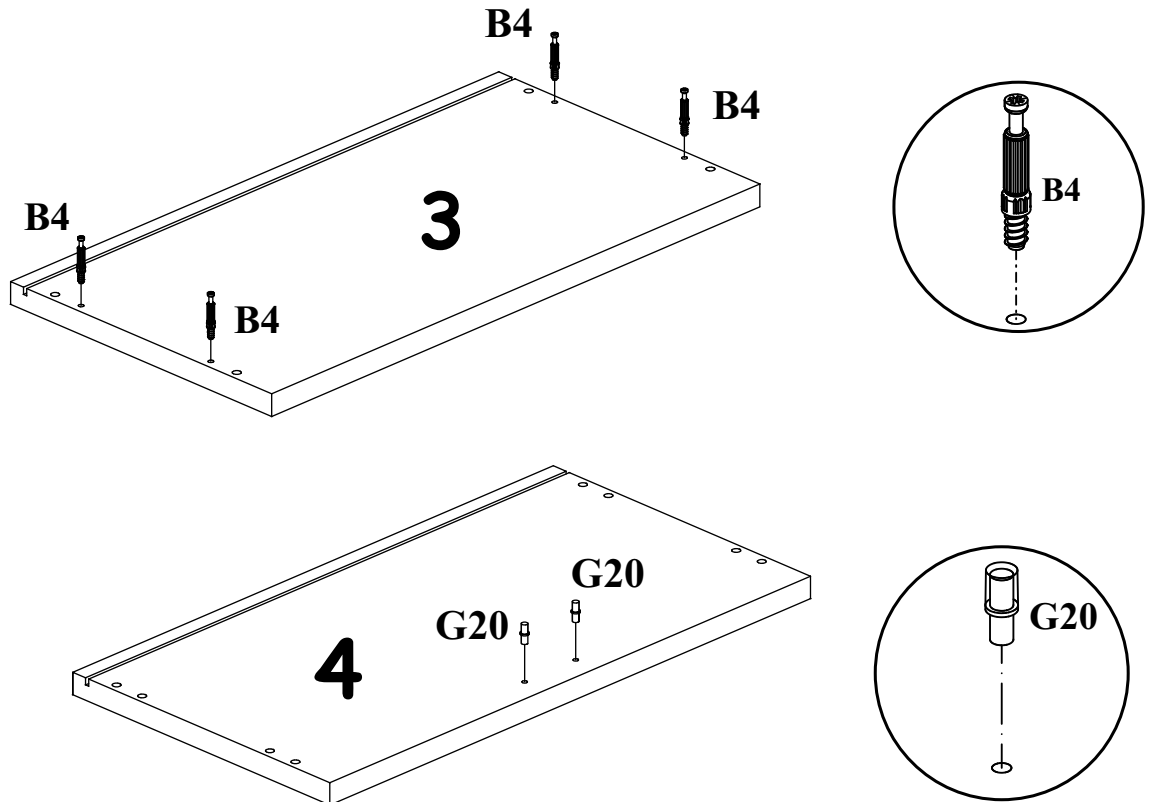

MARIO TYP 3

3

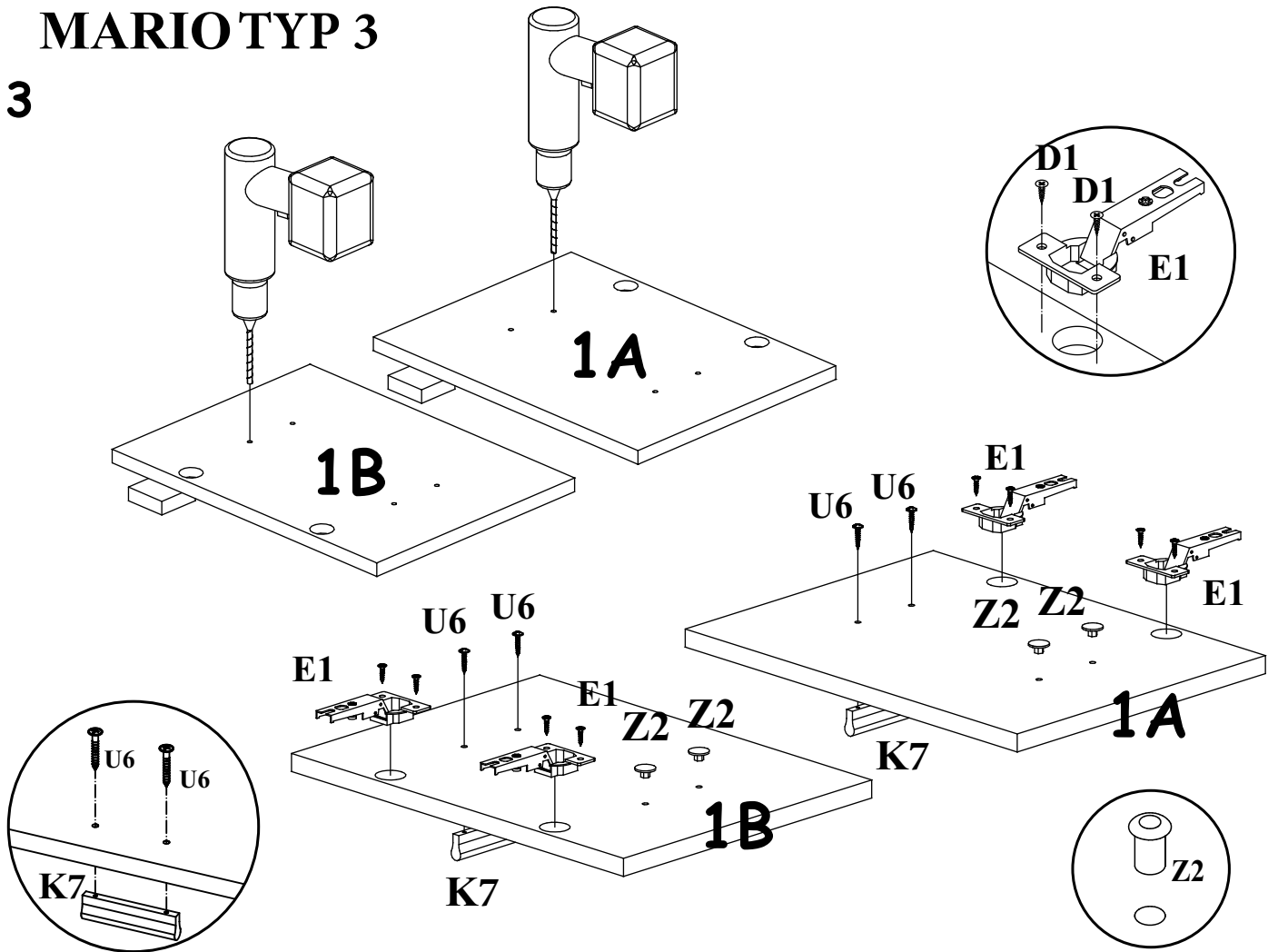

4

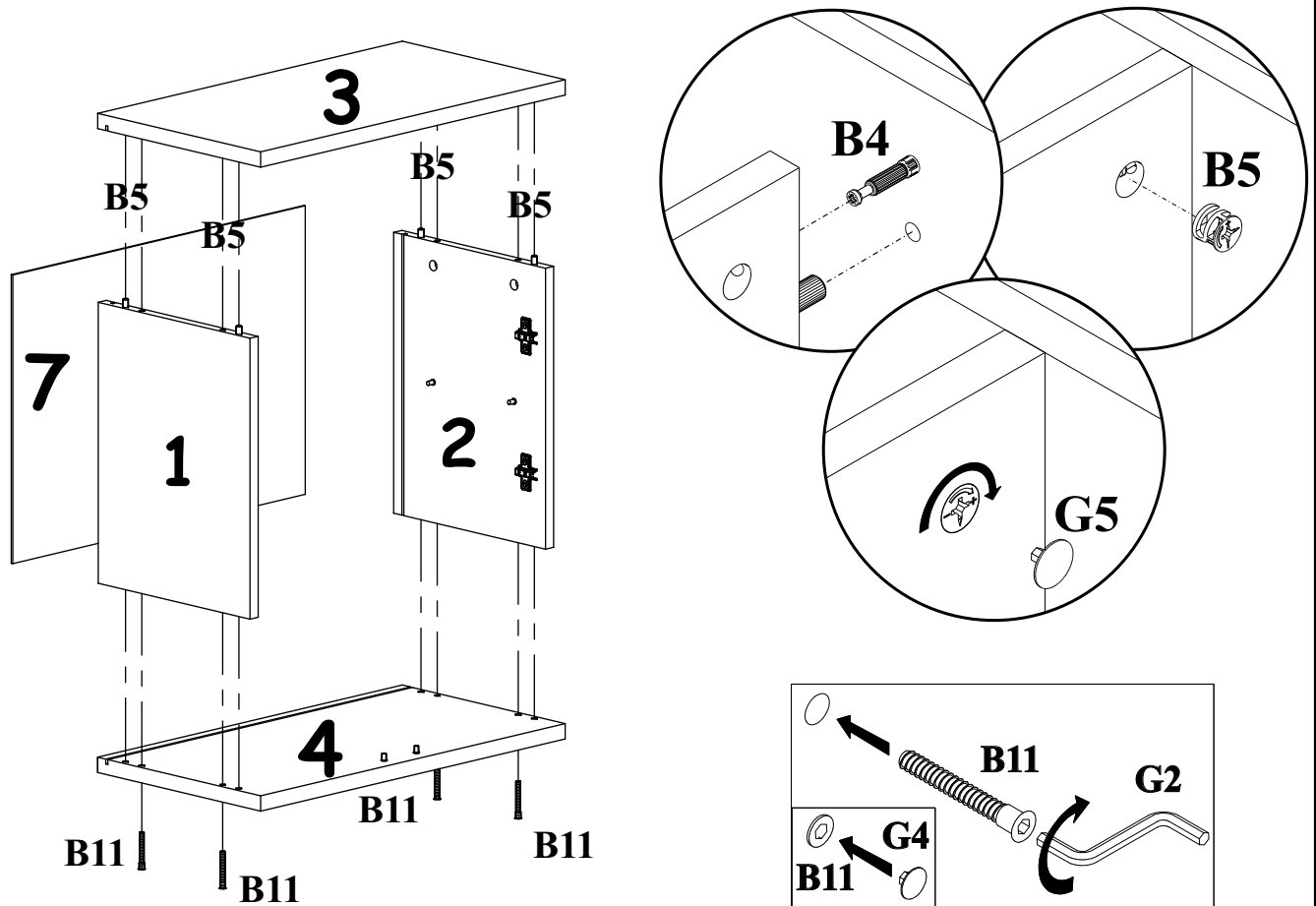

MARIO TYP 3

5

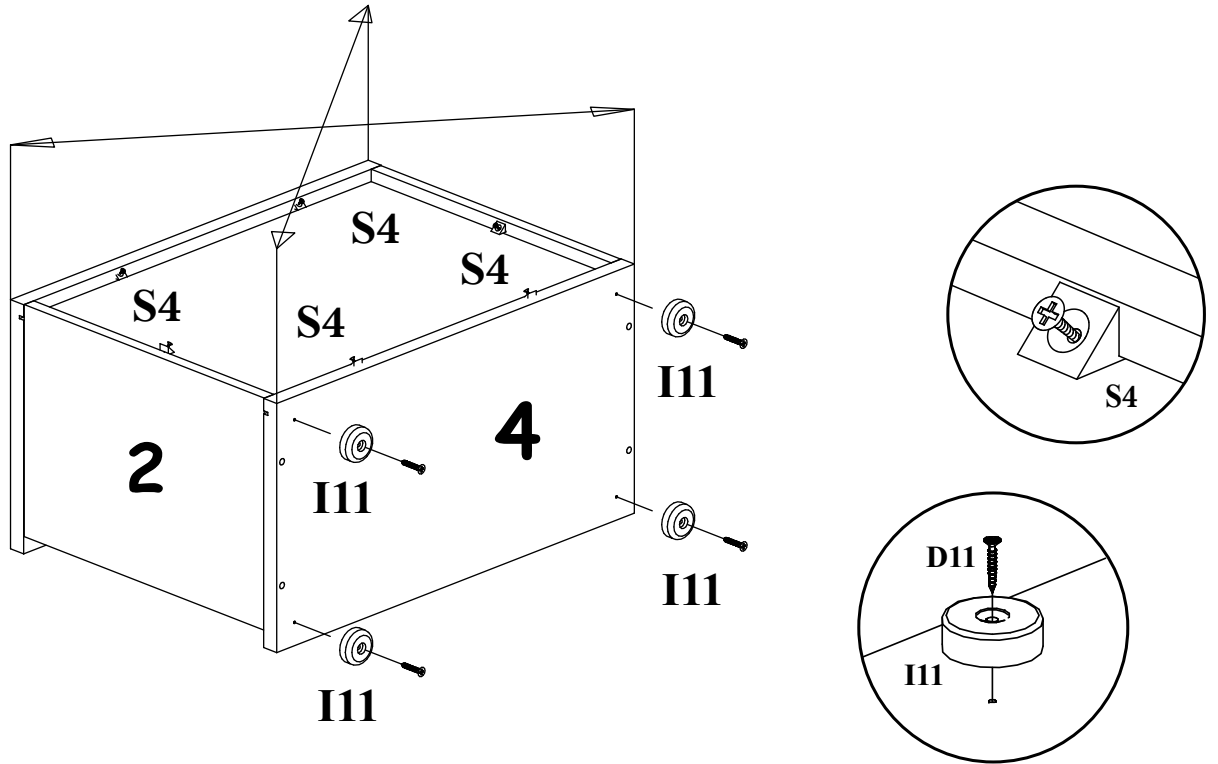

6

