

SK NÁVOD NA MONTÁŽ
CZ MONTÁŽNÍ NÁVOD
HU SZERELÉSI UTASÍTÁS
DE MONTAGEANLEITUNG

WAW NEW OS

	1880	mm
	1850	
	300	

1.

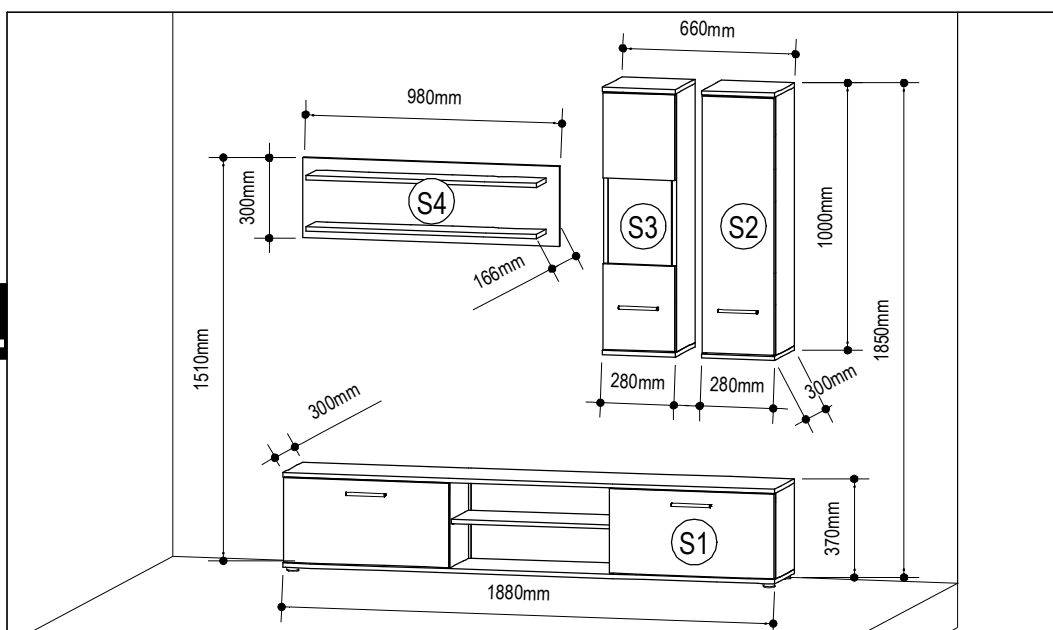

2.

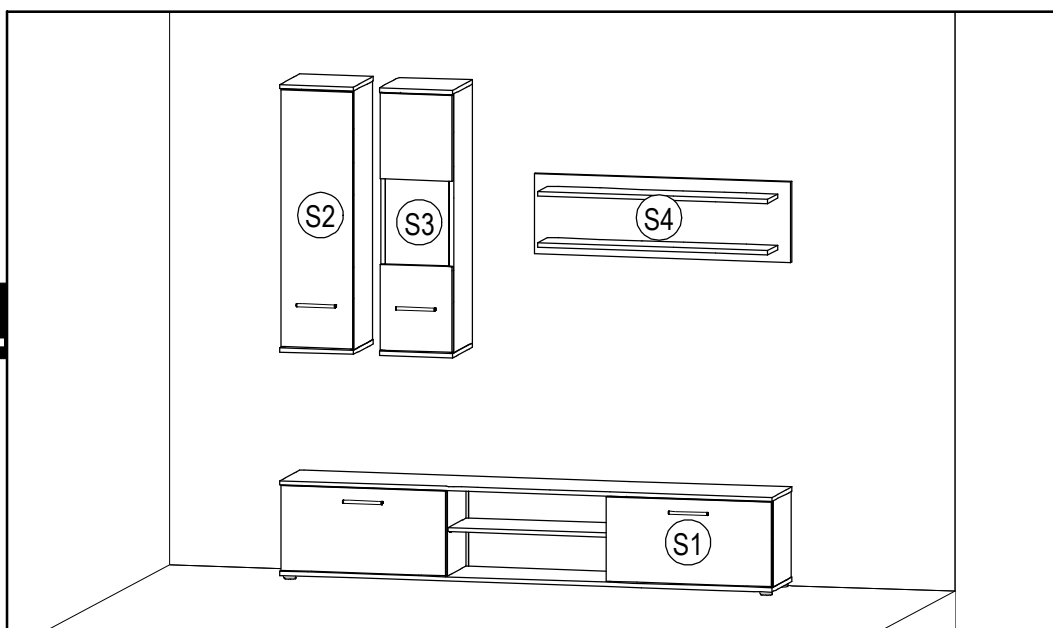

3.

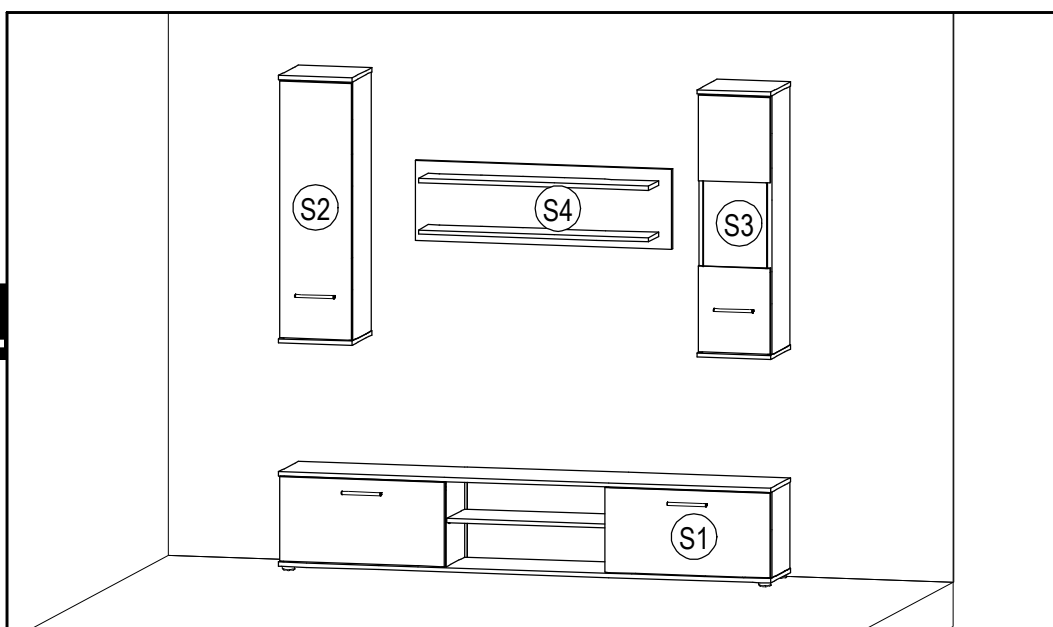

SK NÁVOD NA MONTÁŽ
 CZ MONTÁŽNÍ NÁVOD
 HU SZERELÉSI UTASÍTÁS
 DE MONTAGEANLEITUNG

WAW NEW OS - S1

	1880	mm
	370	
	300	

	 60 min		 PZ2		 3m	 600 mm
--	------------	--	---------	--	--------	------------



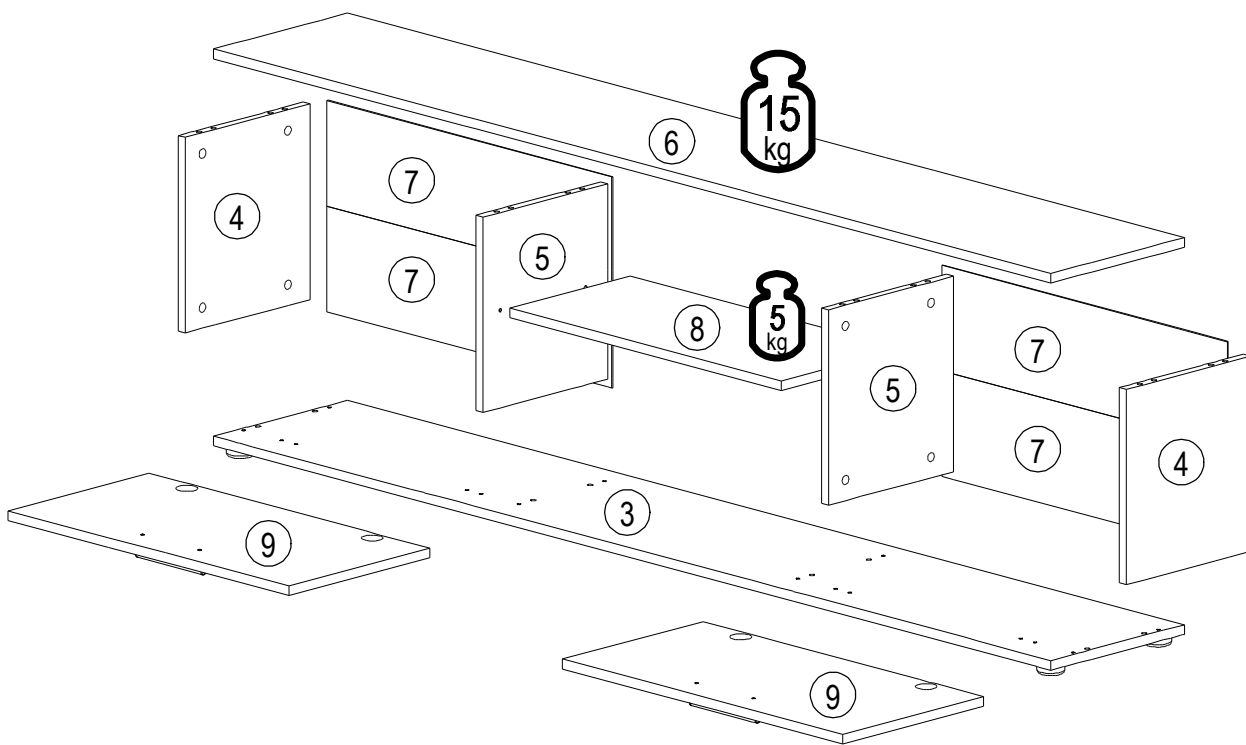
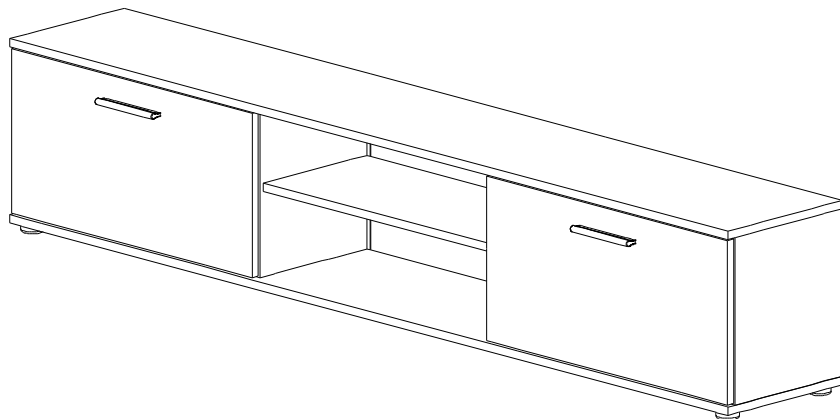



13408	3	1880*300*16	1x	2/2
13409	4	322*280*16	2x	2/2
13410	5	322*280*16	2x	2/2
13411	6	1880*300*16	1x	2/2
13412	7	640*174*2,5	4x	2/2
13413	8	610*270*16	1x	2/2
13414	9	630*316*16	2x	2/2

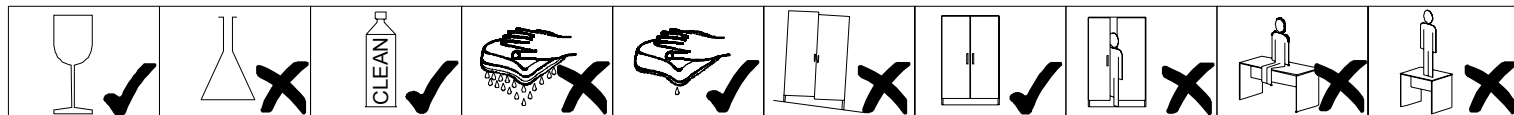





 Ø4x25		 Ø8x30		 Ø3,5x15	 Ø44x15			 Ø1,2x20	
A 6x	B 16x	C 16x	D 2x	E 8x	F 6x	G 16x	H 16x	J 36x	K 4x

		 Ø4x25
L 4x	M 4x	N 4x

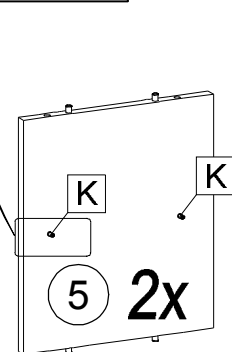
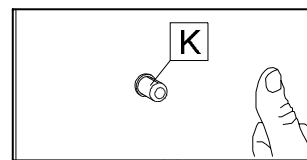
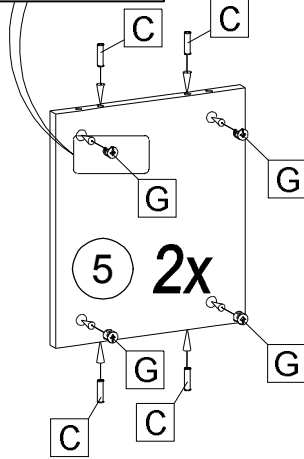
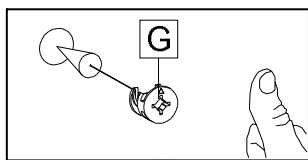
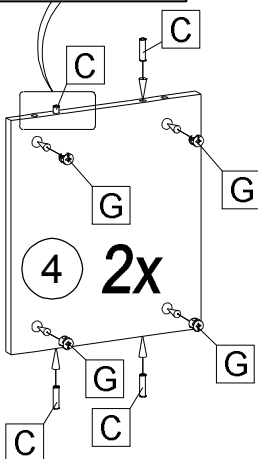
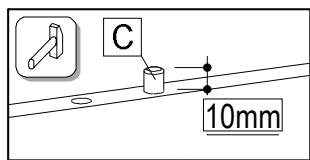
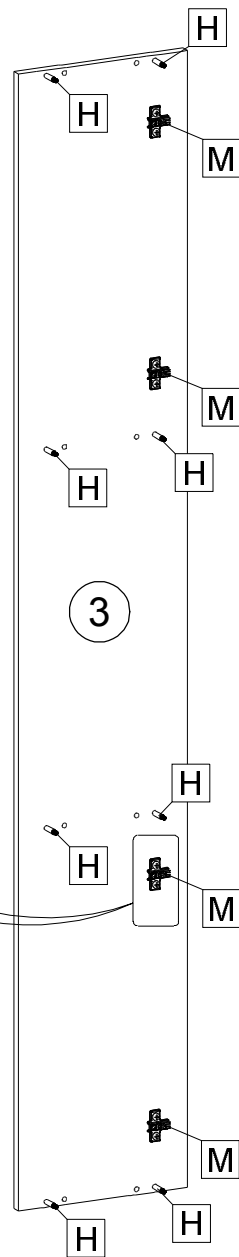
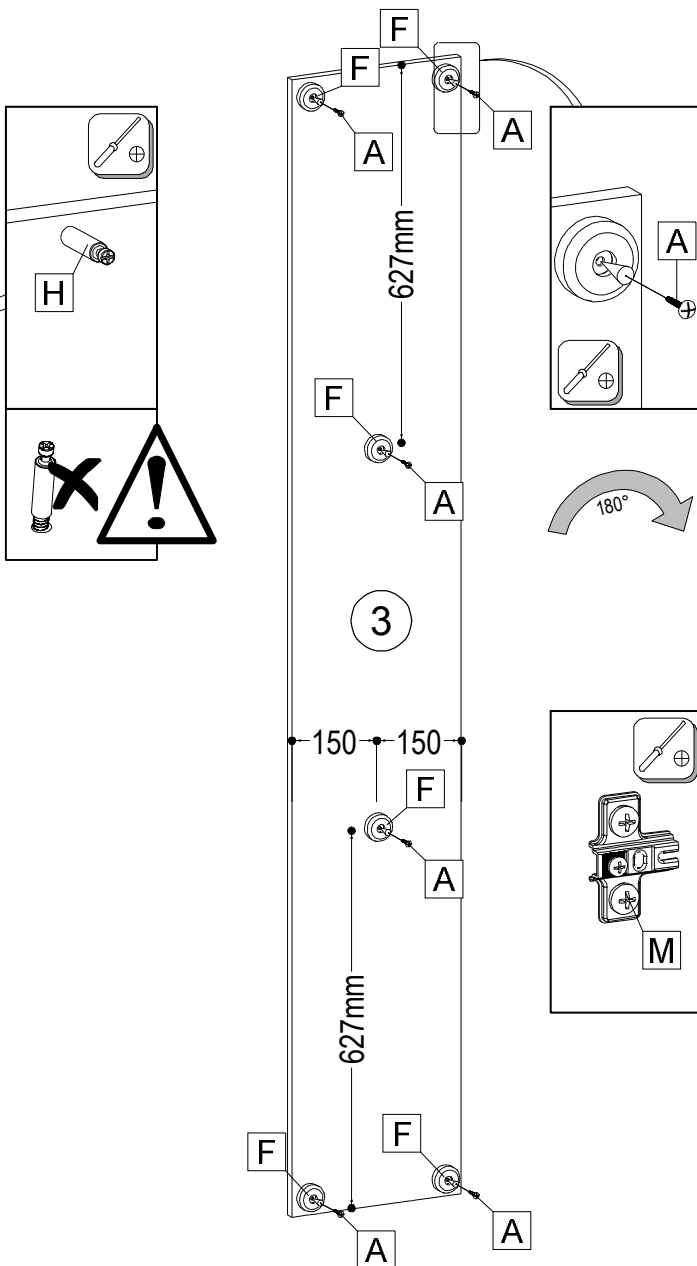
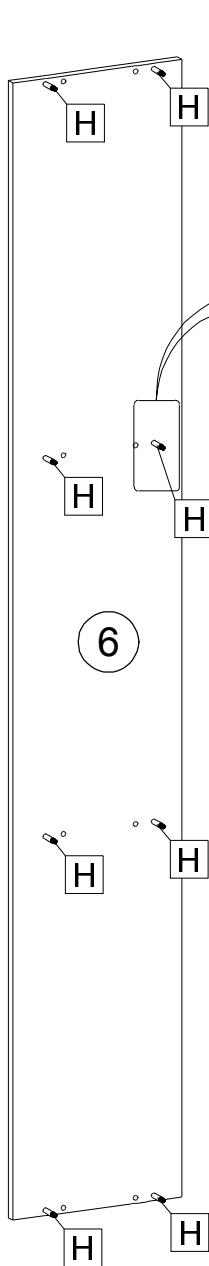

						
Ø4x25	Ø8x30	Ø44x15				
A 6x	C 16x	F 6x	G 16x	H 16x	K 4x	M 4x

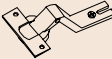

			
	Ø3,5x15		Ø4x25
D 2x	E 8x	L 4x	N 4x

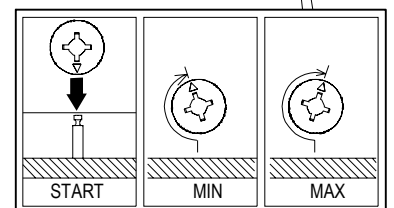
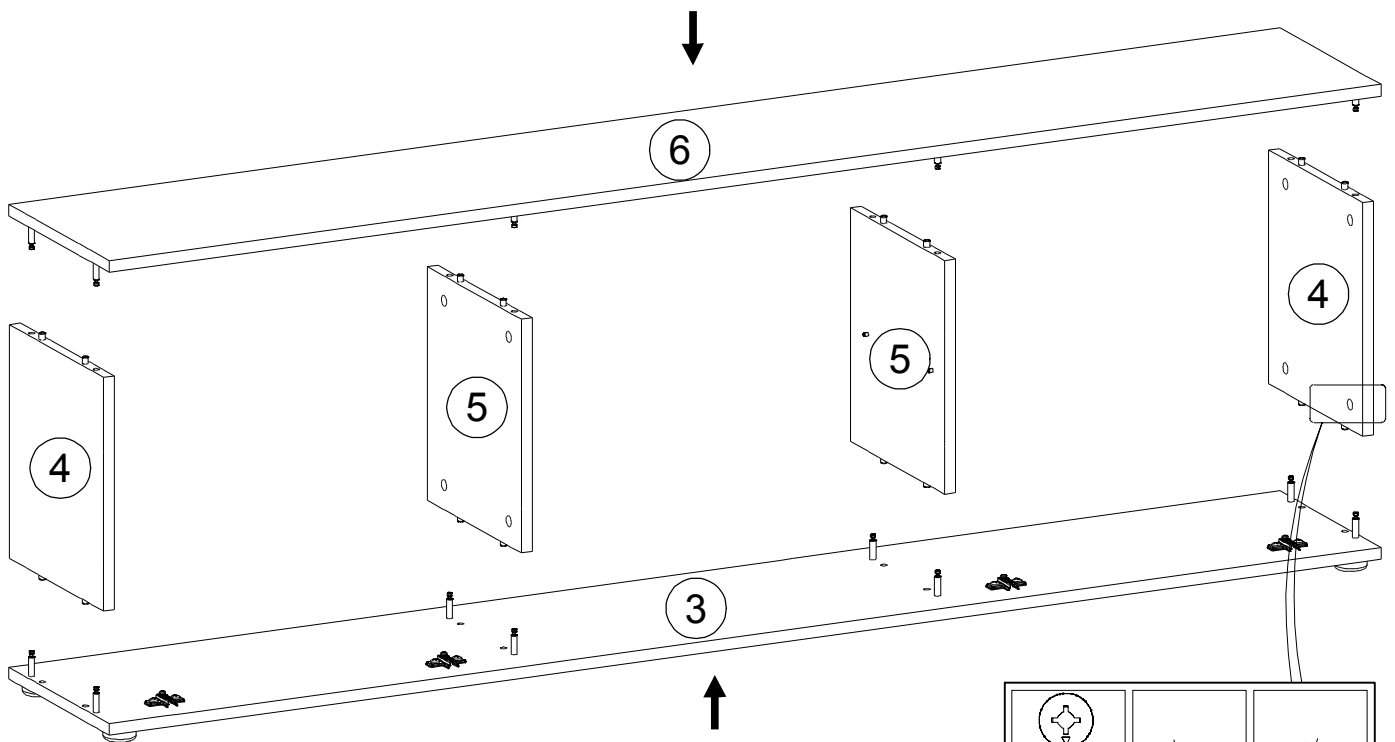
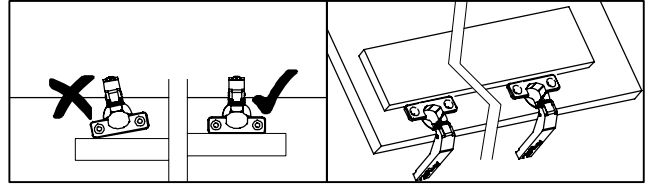
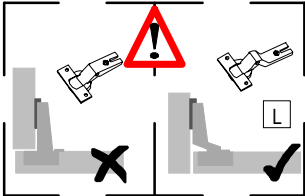
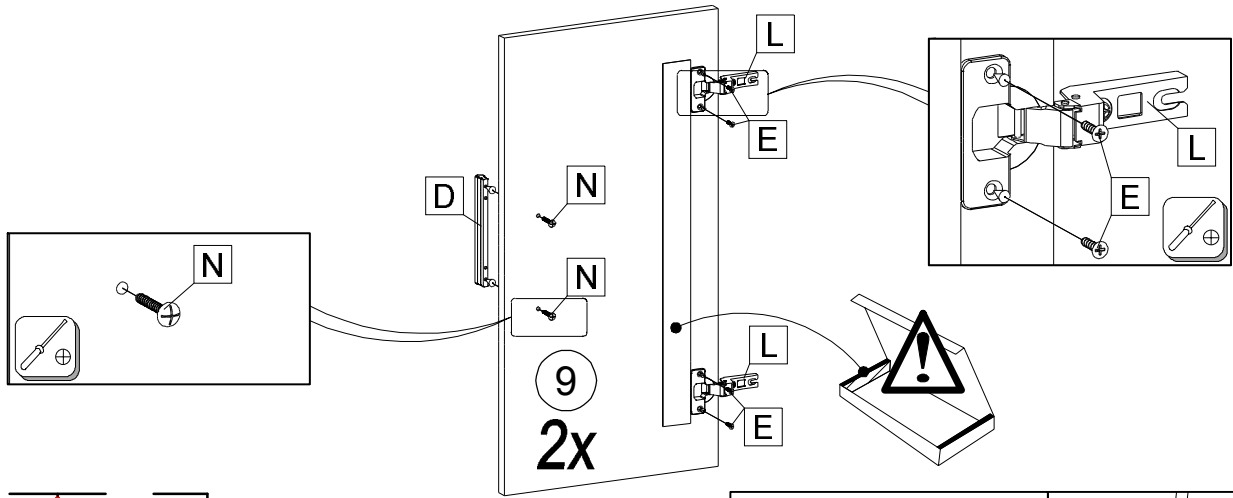

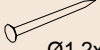
	Ø1,2x20
J	36x

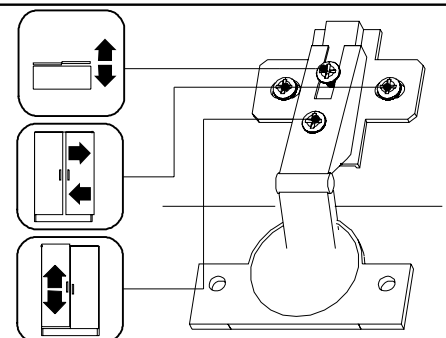
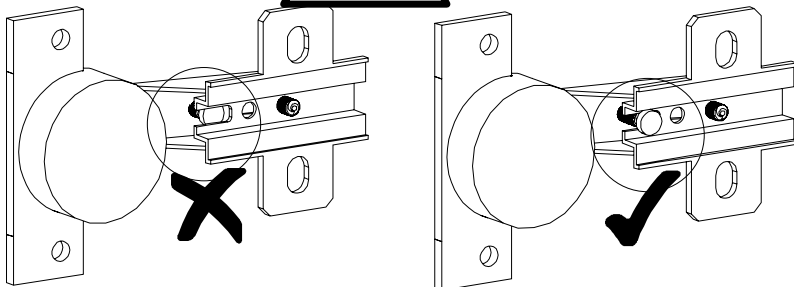
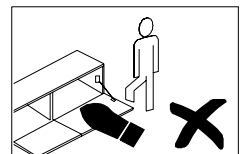
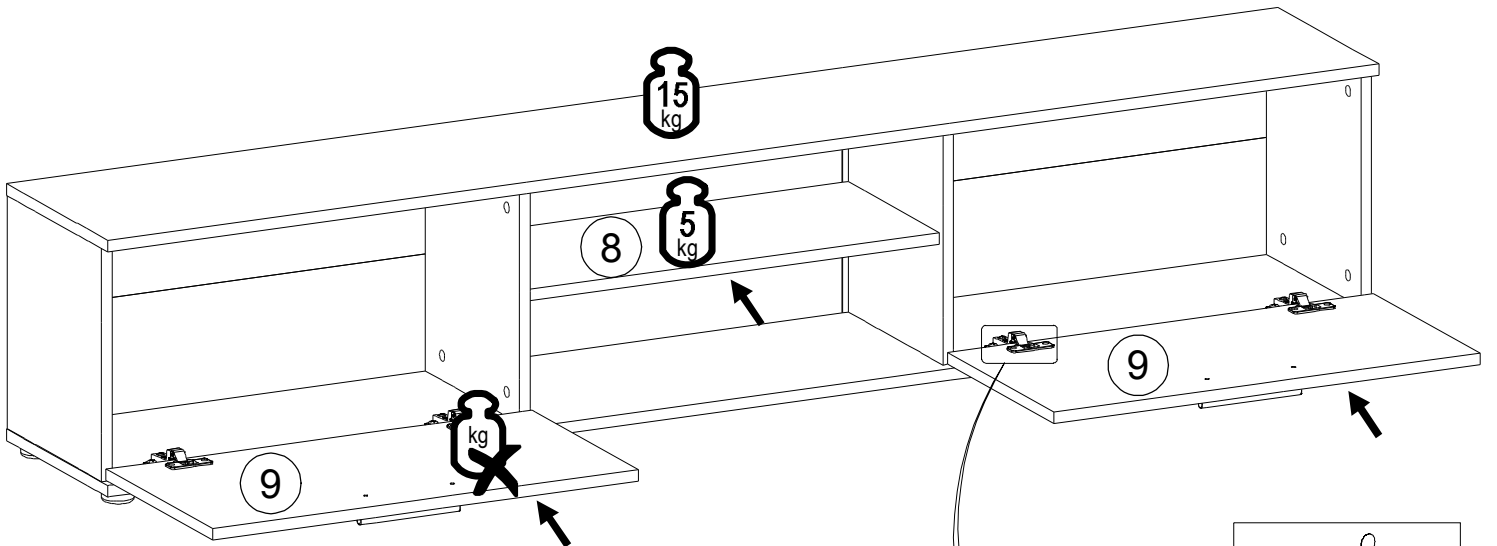
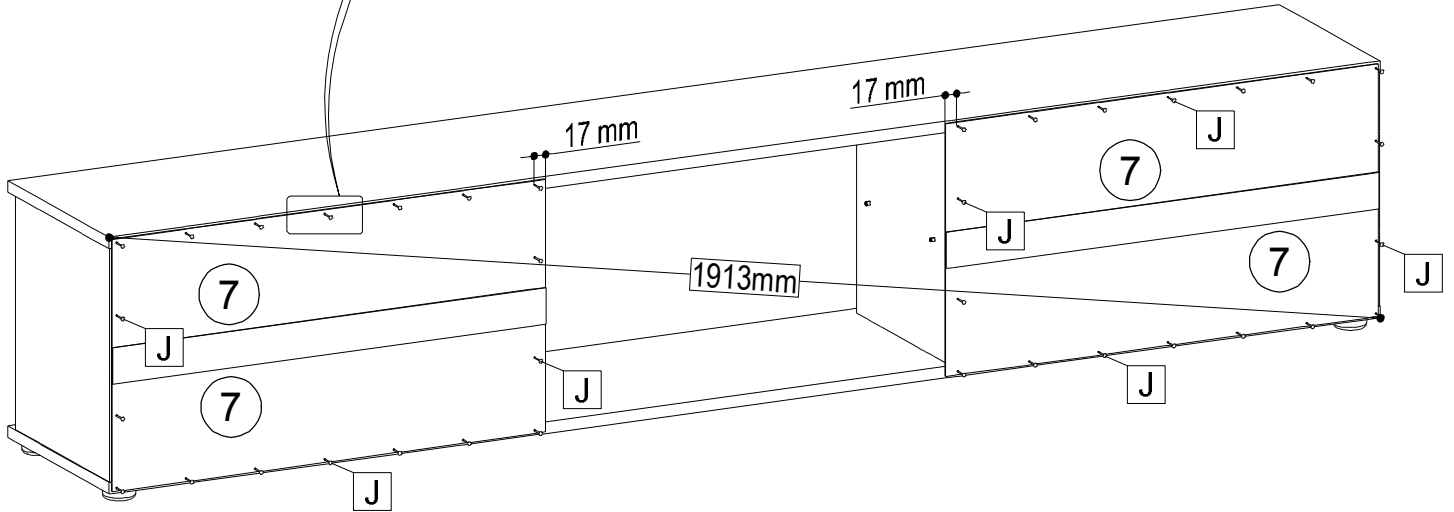
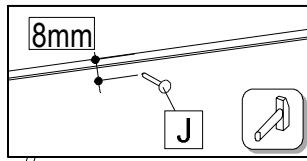

SK NÁVOD NA MONTÁŽ
 CZ MONTÁŽNÍ NÁVOD
 HU SZERELÉSI UTASÍTÁS
 DE MONTAGEANLEITUNG

WAW NEW OS - S2/S3

	280	mm
	1000	
	300	

	100 min		0,5 kg		600 mm	3m	Ø5, Ø10	
--	---------	--	--------	--	--------	----	---------	--

ID	ID			
13415	(11)	968*280*16	4x	1/2
13416	(12)	280*300*16	4x	1/2
13417	(13)	994*274*2,5	2x	1/2
13418	(14)	246*270*16	2x	1/2
13418	(14)	246*270*16	2x	2/2
13419	(15)	960*274*16	1x	1/2
13420	(16)	320*274*16	1x	1/2
13421	(17)	320*274*16	1x	1/2
13422	(18)	380*242*4	1x	1/2

A S2 A S3 B S2 B S3

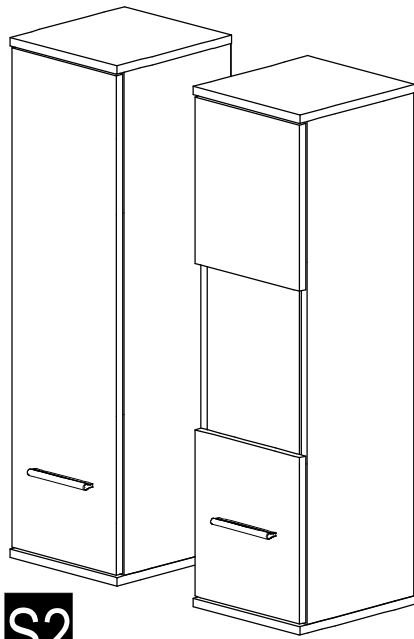
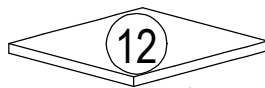
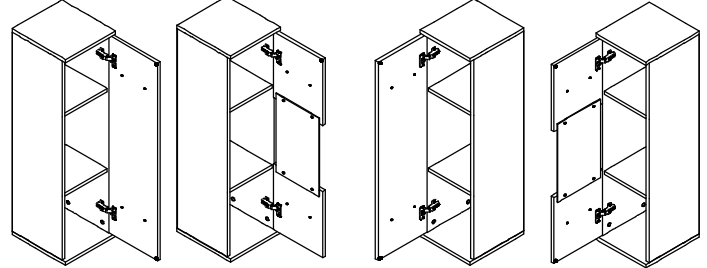

S2

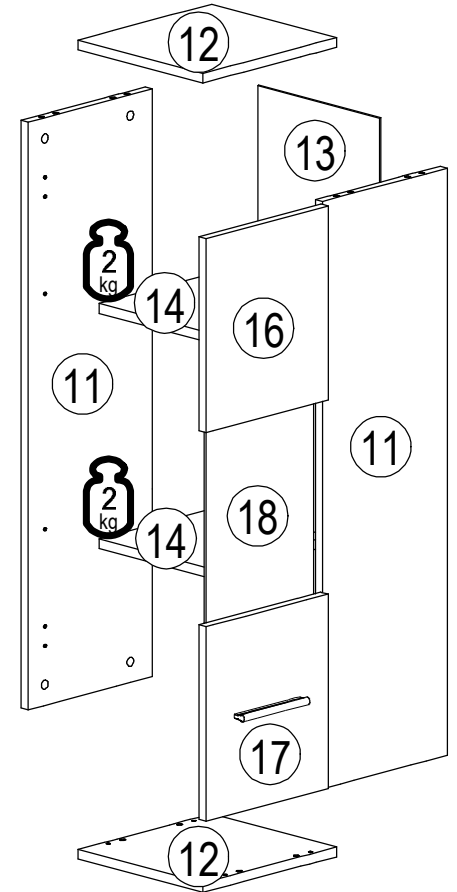
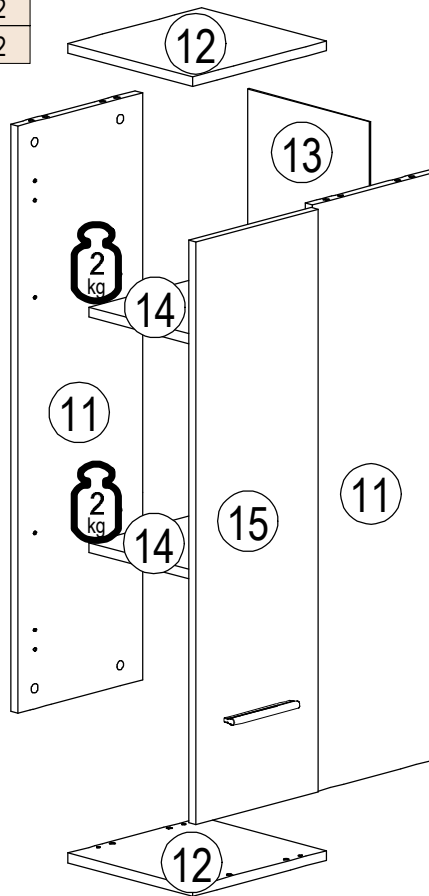

S3

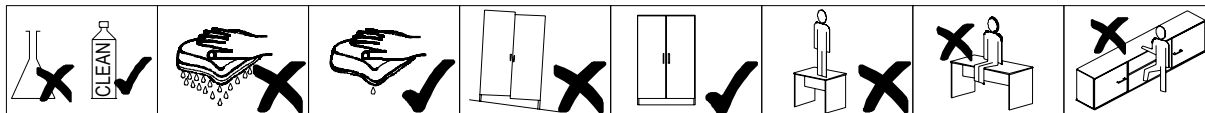

22243.00 Ø3,5x15	22430.00 Ø4x25	27000.00 Ø8x30	35101.01 	70013.01 	70021.01 		36002.07 	36002.07 	32030.00
A 8x	B 4x	C 16x	D 16x	E 16x	F 16x	G 16x	H 4x	J 4x	K 2x

21102.00 Ø1,2x20	31000.01 	24101.00 Ø10	22206.00 Ø5x60	22244.01 Ø3,5x16	35214.00 	8402.03 	35009.01
L 50x	M 4x	N 4x	P 4x	Q 4x	R 4x	S 4x	T 4x

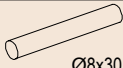

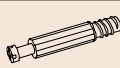
			
Ø8x30			
C 16x	D 16x	E 16x	F 16x

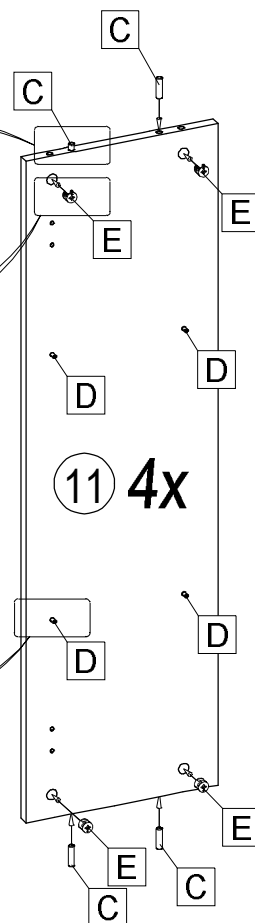
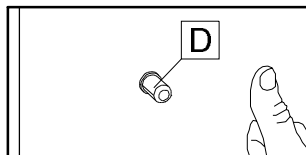
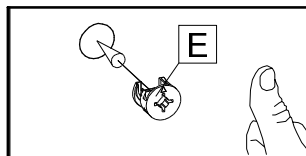
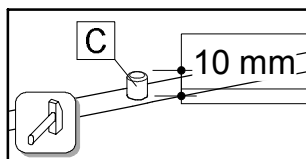
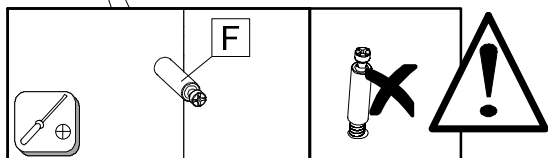
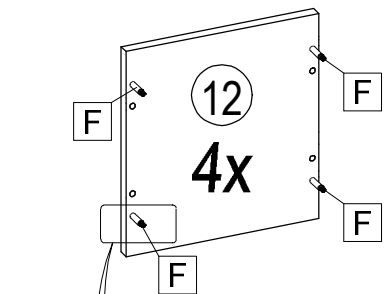

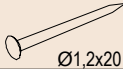
Ø1,2x20
L 50x

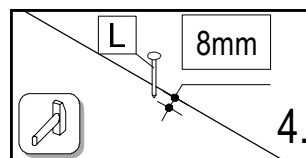
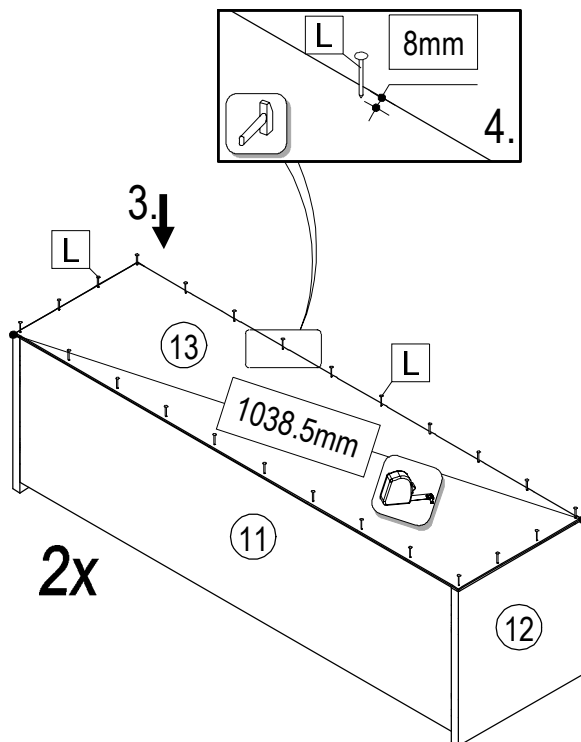
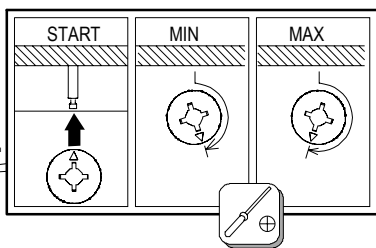
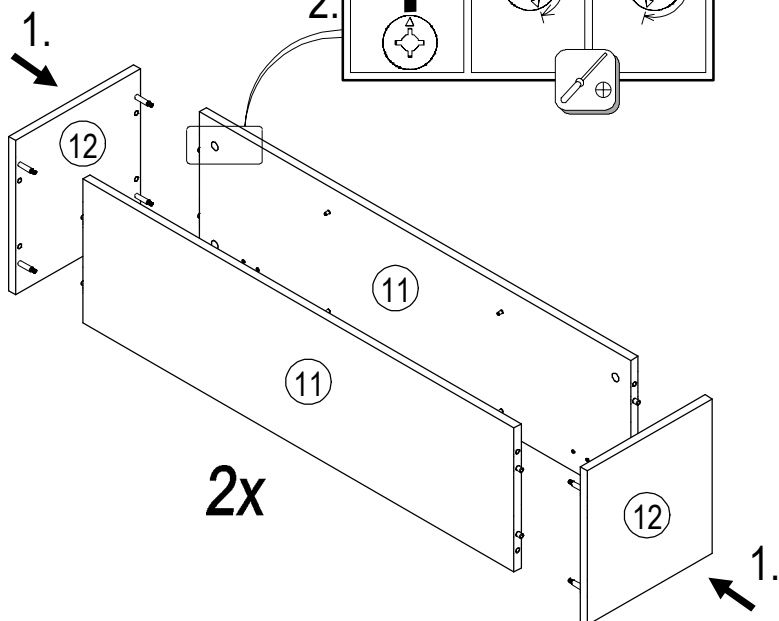

A 8x	M 4x
N 4x	P 4x

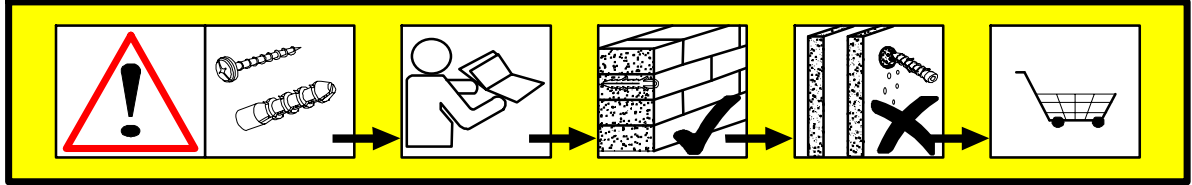



Achtung! Die Wandbeschaffenheit ist vor der Montage unbedingt zu prüfen. Die beigelegten Universaldübel sind ausschließlich nur zur Verwendung für festes Mauerwerk wie Beton/Ziegel. Die Mauerdübel dürfen nicht bei Mauerwerk wie Hohlraumziegel, Leichtbausteinen, Gipskartonplatte oder anderer Rahmenbauweise verwendet werden. Bei diesen Mauerwerken sind gegebenenfalls Spezialdübel zu verwenden! Diese sind in einem Fachgeschäft (Baumarkt) erhältlich. Bei Nichteinhaltung wird seitens Produzenten/Händler und Importeur keine Haftung übernommen.

Vigyázat! Szerelés előtt a falfelületet feltétlenül vizsgálja meg. A mellékelt univerzális tipl kizárólag stabil falazathoz használható mint például beton/tégla. A fal tipl nem használható könnyű építőkövek hez, üreg tégla, gipszkarton lapokhoz vagy más favázás építményekhez. Ezekhez a falfelületekhez csak speciális tiplik használhatóak, melyek szaküzletekben (barkácsáruházakban) beszerezhetőek. Fentiek figyelmen kívül hagyása esetén a gyártó/kereskedő vagy forgalmazó nem vállal felelősséget.

Upozornenie! Pevnosť steny sa musí pred montážou bezpodmienečne skontrolovať. Univerzálne hmoždenky, ktoré sú obsiahnuté v balení, používajte jedine pre pevné murivo ako je betón/tehla. Hmoždenky sa nesmú používať v prípade ľahkého staveného muríva, dutina tehla, u sádrokartónových dosiek alebo iných konštrukcií rámu. U týchto murív je nutné použiť špeciálne hmoždenky! Tieto je možné dostať v špeciálnych predajniach so stavebným materiálom (stavebniny). Pri nedodržaní pokynov nepreberajú výrobcovia/predajci a dodávateľa zodpovednosť za vzniknuté škody.

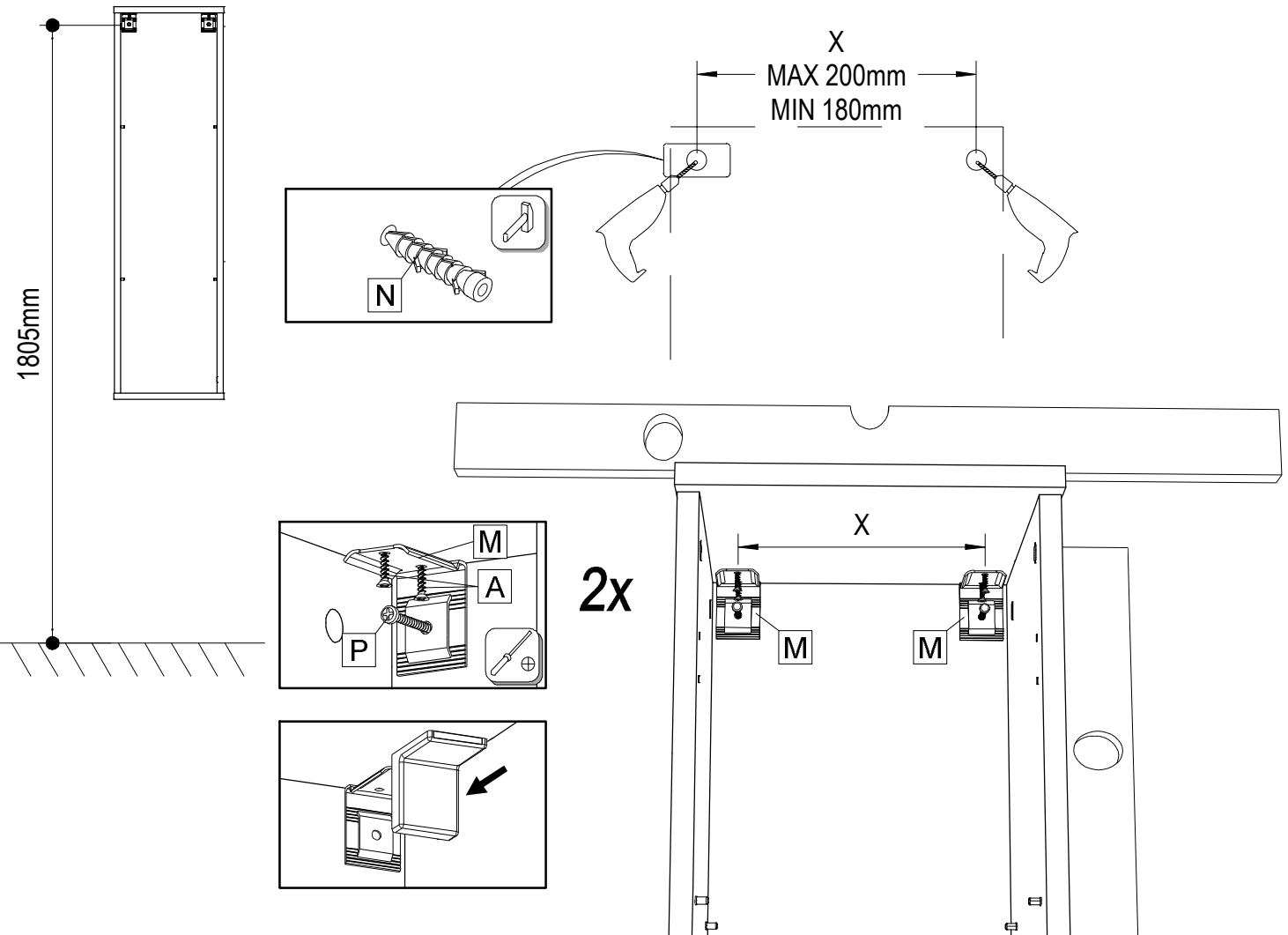

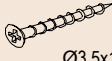
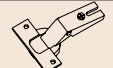

Upozornění! Před montáží je nutné zkontrolovat stav stěny. Přiložené univerzální hmoždinky jsou určeny pouze k použití pro pevné zdivo jako beton/cihly. Hmoždinky do zdi se nesmí používat u dutinová cihla, zdiva jako pórovitý stavební kámen, sádrokartónová deska nebo jiný měkký materiál. U těchto zdív jsou nutné použít speciální hmoždinky! Jsou k dostání v speciálních prodejnách se stavebním materiálem. Při nedodržení těchto pokynů výrobce/prodejece a dovozce neručí za způsobené škody.

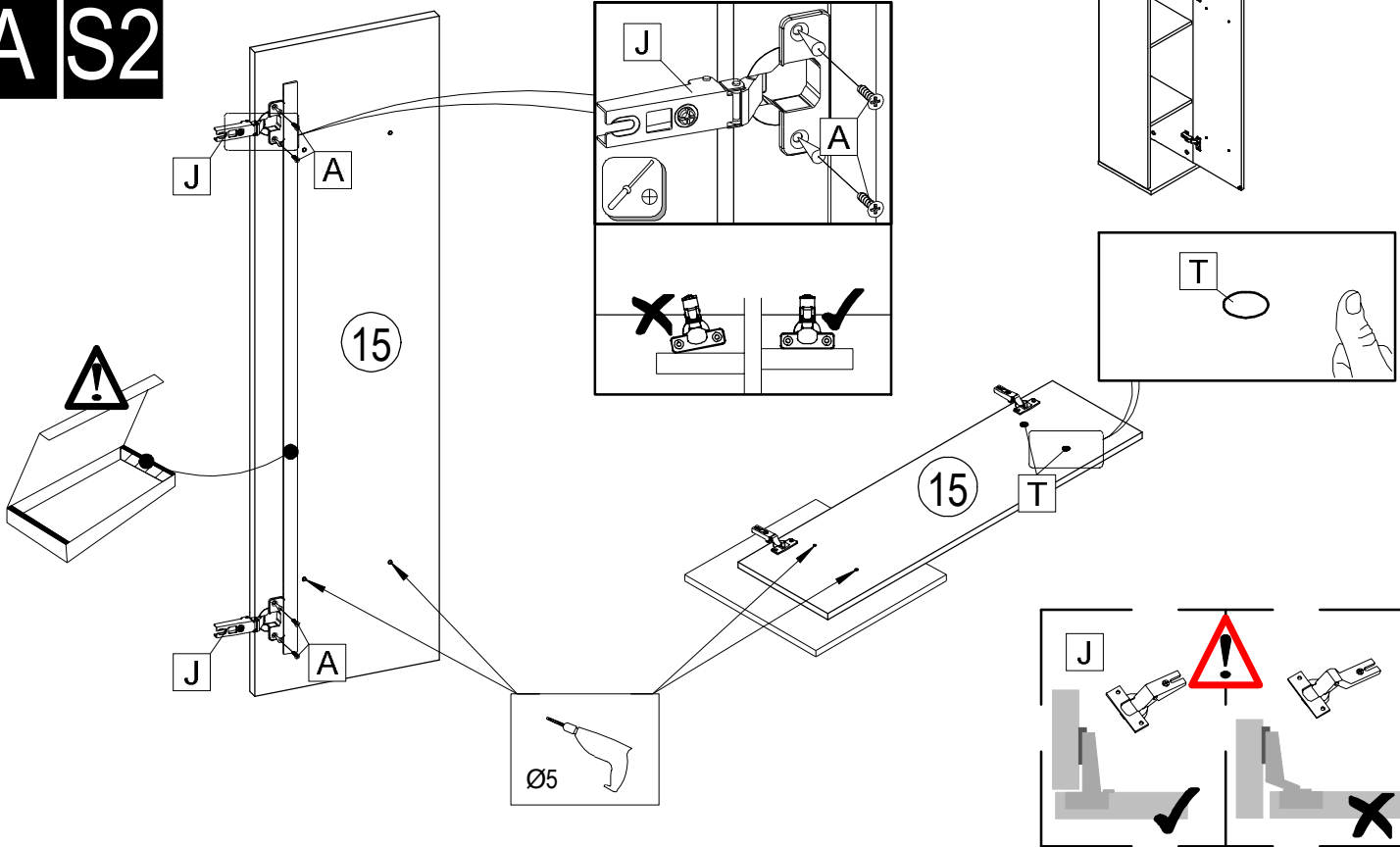

		
Ø3,5x15		
A 4x	J 2x	T 2x

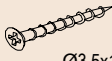
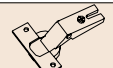



A S2

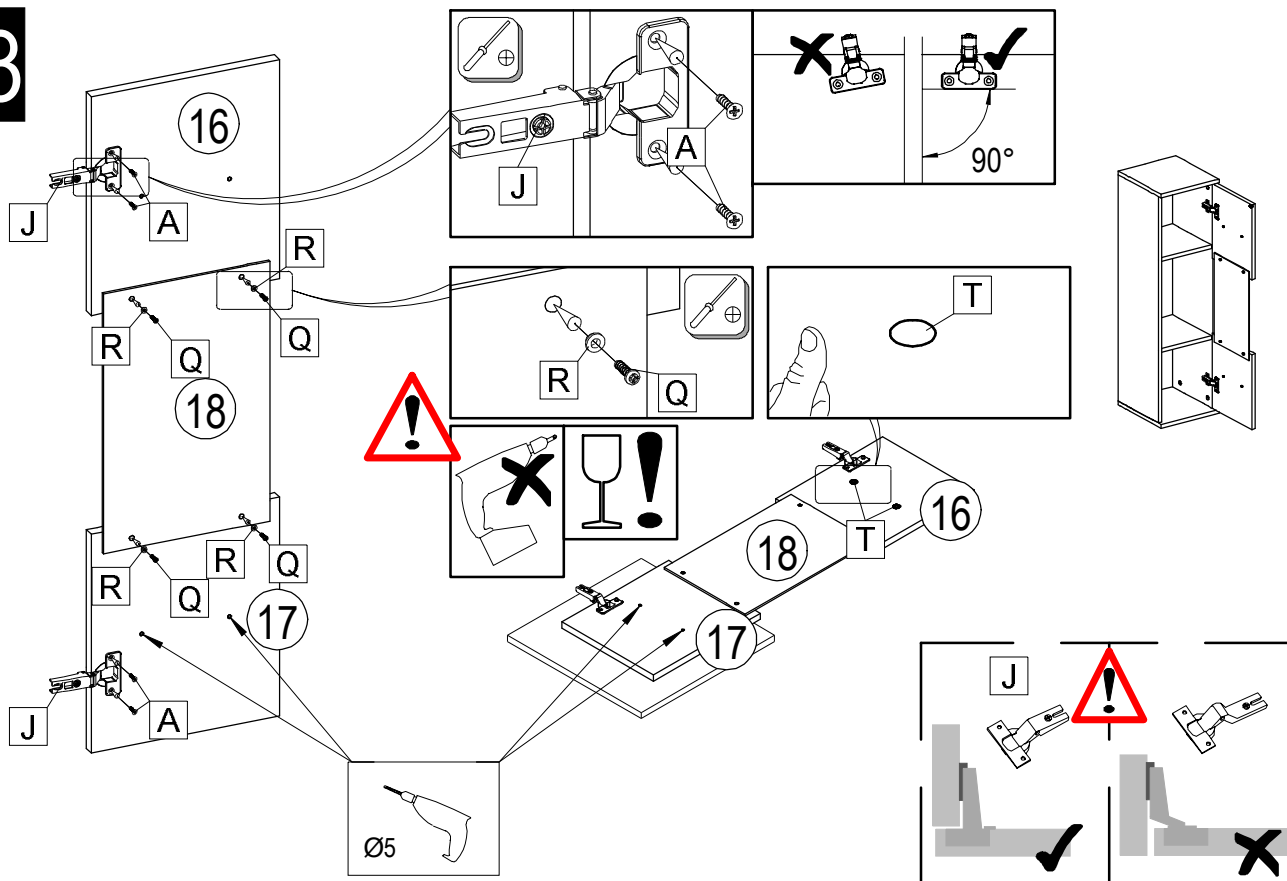

				
Ø3,5x15		Ø3,5x16		
A 4x	J 2x	Q 4x	R 4x	T 2x





A S3

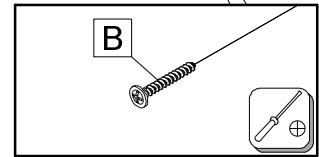
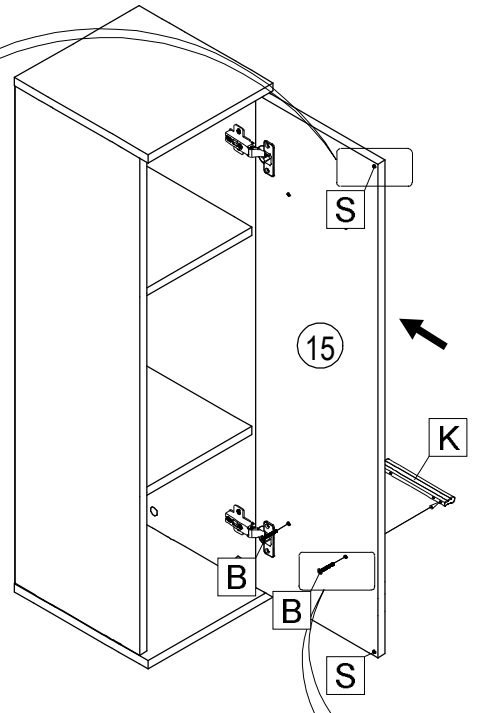
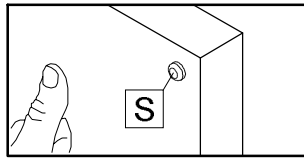
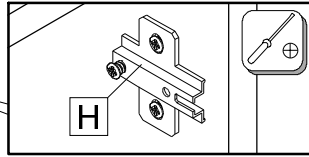
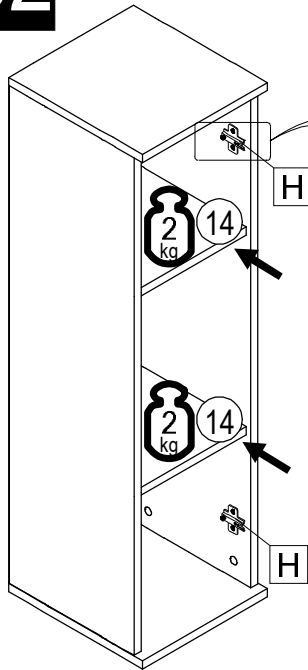

			
Ø4x25			
B 2x	H 2x	K 1x	S 2x



A S2



			
Ø4x25			
B 2x	H 2x	K 1x	S 2x

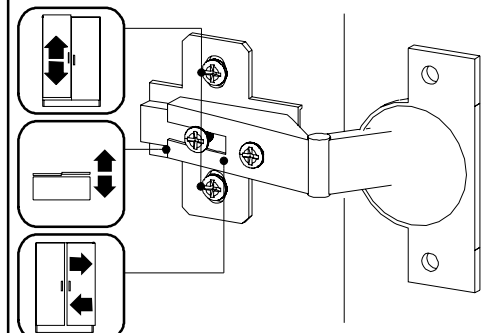
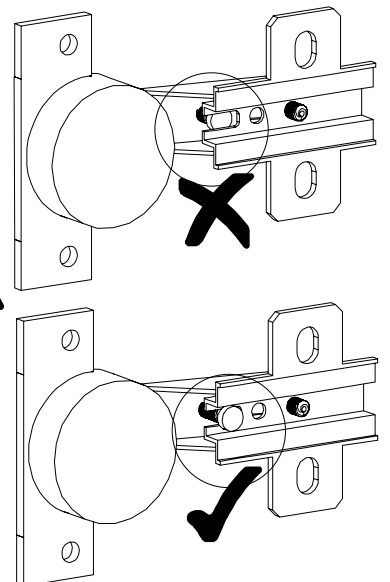
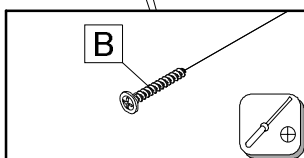
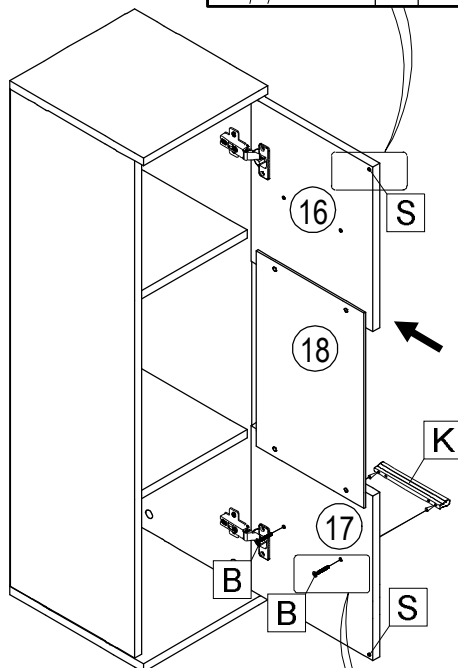
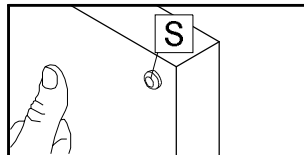
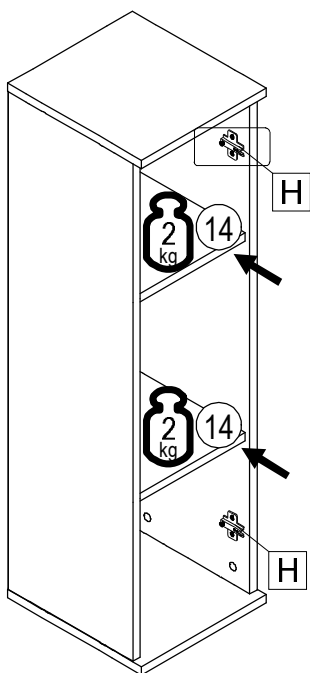
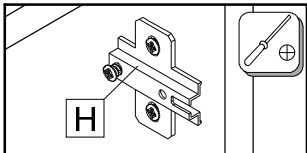

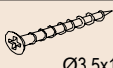
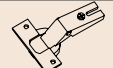
A S3



		
Ø3,5x15		
A 4x	J 2x	T 2x

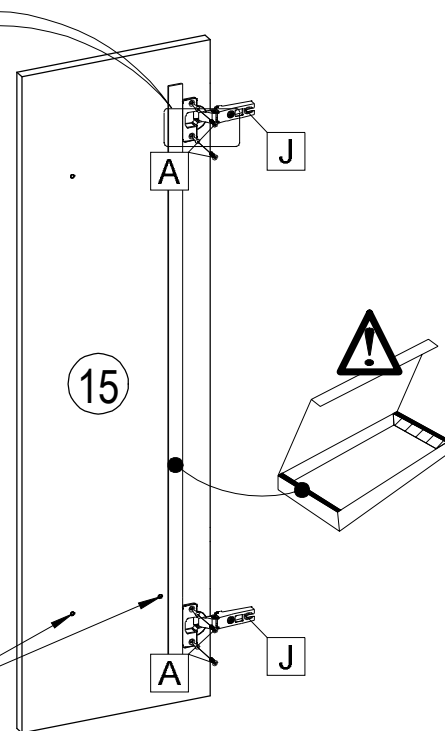
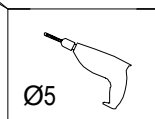
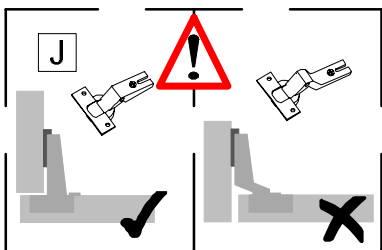
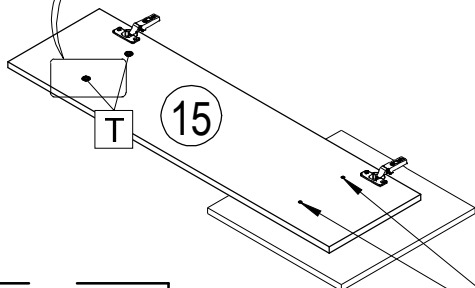
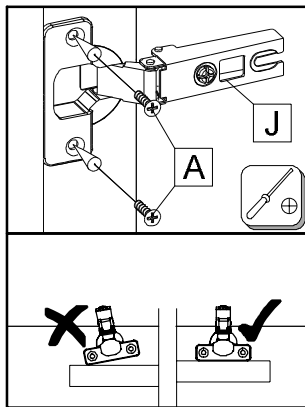
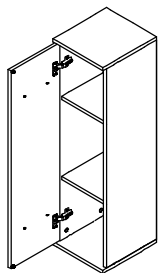
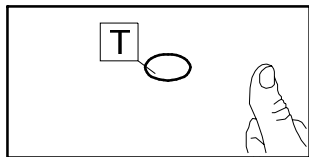

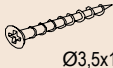
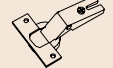
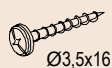

B S2

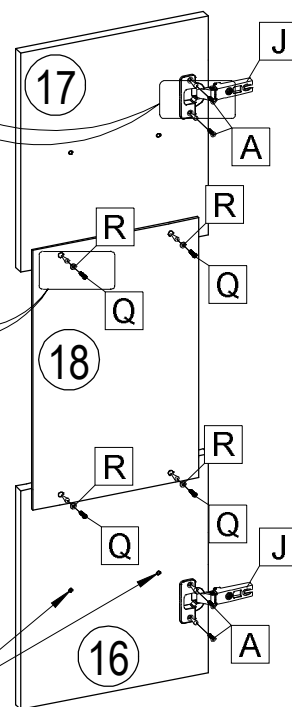
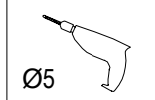
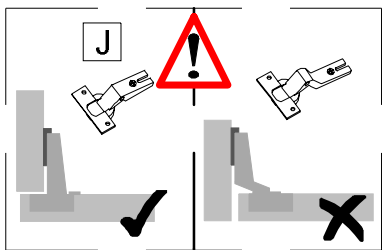
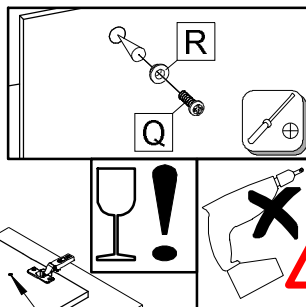
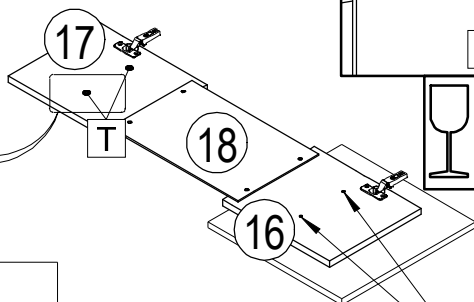
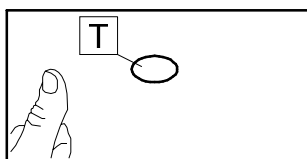
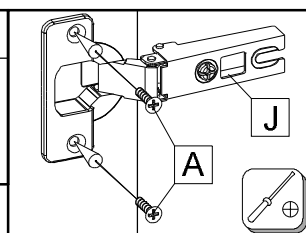
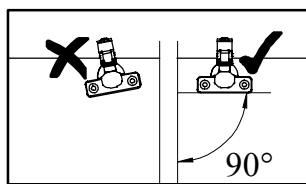
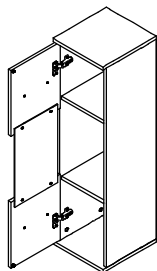

				
Ø3,5x15		Ø3,5x16		
A 4x	J 2x	Q 4x	R 4x	T 2x





B S3

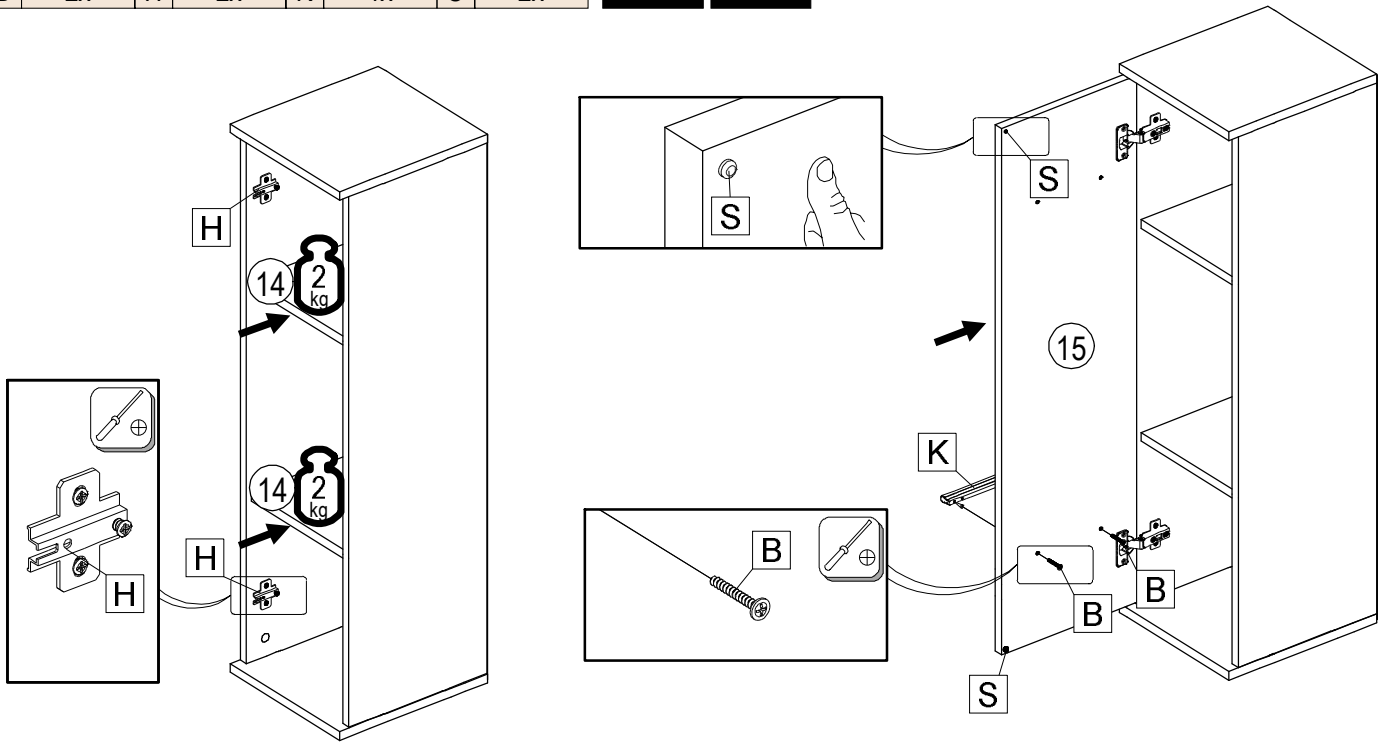

			
Ø4x25			
B 2x	H 2x	K 1x	S 2x

B S2



			
Ø4x25			
B 2x	H 2x	K 1x	S 2x

B S3

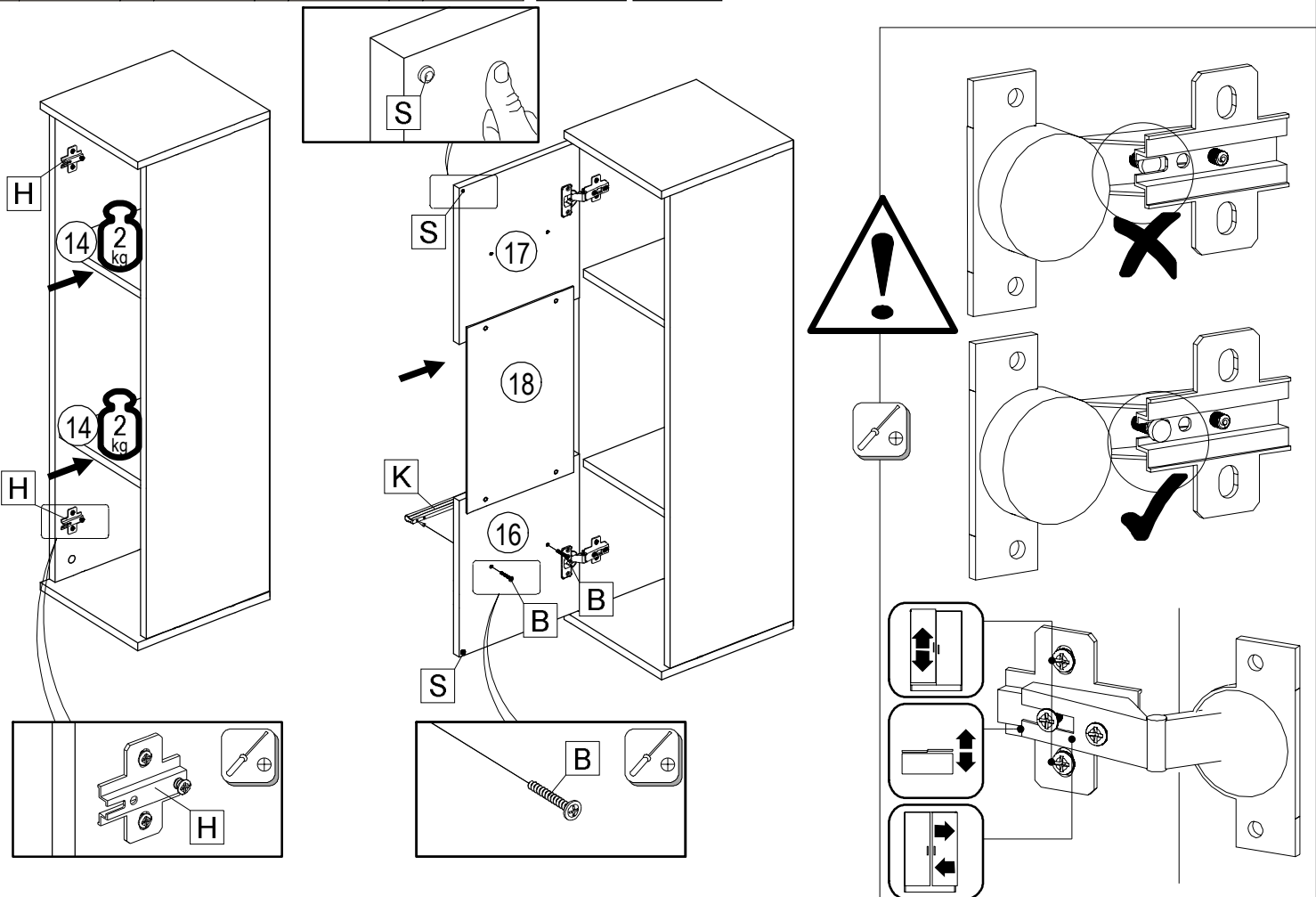

SK NÁVOD NA MONTÁŽ
 CZ MONTÁŽNÍ NÁVOD
 HU SZERELÉSI UTASÍTÁS
 DE MONTAGEANLEITUNG

WAW NEW OS - S4

	1500	mm
	230	
	202	

13423	20	980*300*16	1x	2/2
13424	21	880*150*16	2x	2/2

22300,00	24102,02	70789,00	36517,00	22705,00
Ø7x50	Ø12	Ø5,8x50		Ø6,3x8
A 12x	B 2x	C 2x	D 2x	E 4x
			24010,00	22243,00
			F 4x	G 4x
				Ø3,5x15

	0h 30min	
4	≤ 0,5 kg	3m
600 mm		PZ 2

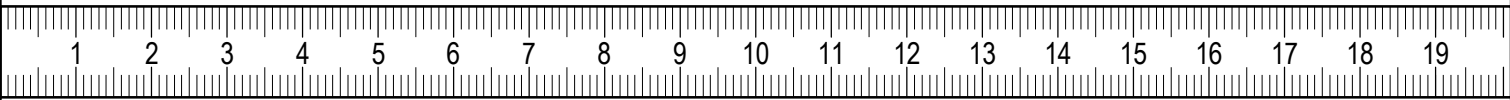
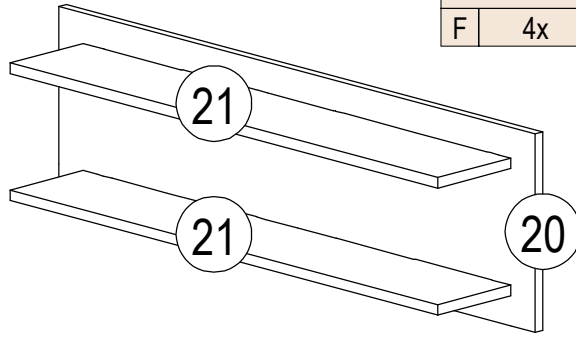

--	--	--	--	--	--	--	--

D 2x	E 6x	F 4x	G 4x
	Ø6,3x8		Ø3,5x15

1.

2.

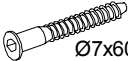
	Ø7x60
A	12x

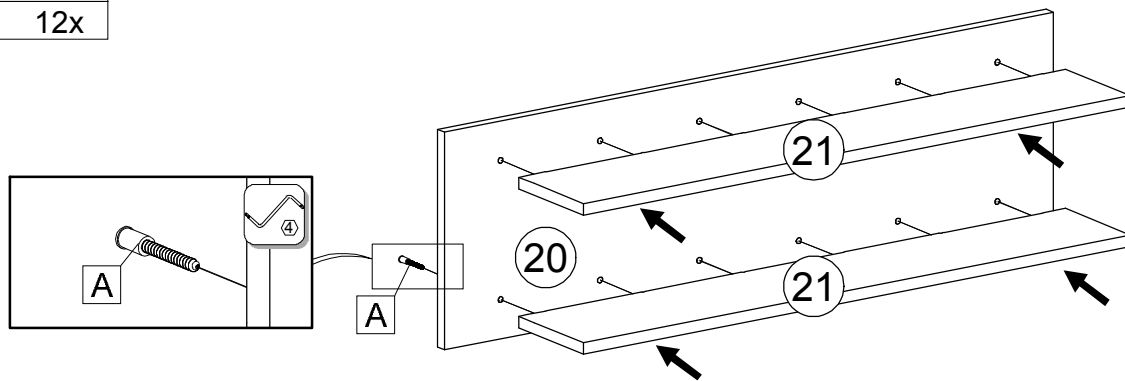

1.

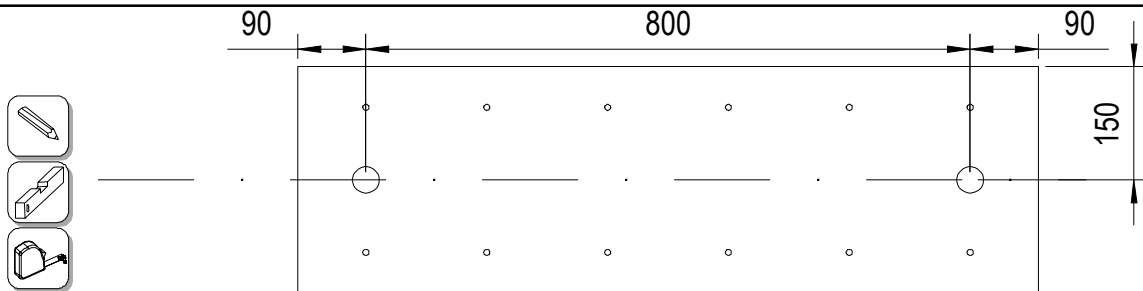

2.

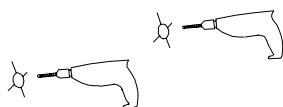

3.

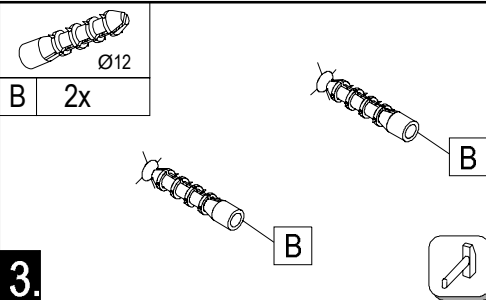

4.

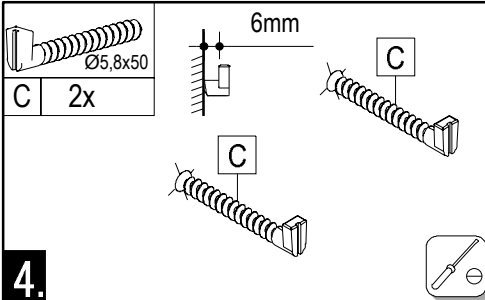

Upozornění! Před montáží je nutné zkontrolovat stav stěny. Přiložené univerzální hmoždinky jsou určeny pouze k použití pro pevné zdivo jako beton/cihly. Hmoždinky do zdi se nesmí používat u dutinové cihly, zdiva jako pórovitý stavební kámen, sádrokartonové desky nebo jiný měkký materiál. U těchto zdí jsou nutné použít speciální hmoždinky! Jsou k dostání v speciálních prodejních se stavebním materiálem. Při nedodržení těchto pokynů výrobce/prodejce a dopravce neručí za způsobené škody.

Achtung! Die Wandbeschaffenheit ist vor der Montage unbedingt zu prüfen. Die beigelegten Universaldübel sind ausschließlich nur zur Verwendung für festes Mauerwerk wie Beton/Ziegel. Die Mauerdübel dürfen nicht bei Mauerwerk wie Hohlraumziegel, Leichtbausteinen, Gipskartonplatte oder anderer Rahmenbauweise verwendet werden. Bei diesen Mauerwerken sind gegebenenfalls Spezialdübel zu verwenden! Diese sind in einem Fachgeschäft (Baumarkt) erhältlich. Bei Nichterhaltung wird seitens Produzenten/Händler und Importeur keine Haftung übernommen.

Upozornenie! Pevnosť steny sa musí pred montážou bezpodmienečne skontrolovať. Univerzálne hmoždenky, ktoré sú obsiahnuté v balení, používajte jedine pre pevné murivo ako je betón/tehla. Hmoždenky sa nesmú používať v prípade ľahkého stavebného muriva, dutina tehla, u sádrokartonových dosiek alebo iných konštrukcií rámu. U týchto murív je nutné použiť špeciálne hmoždenky! Tieto je možné dostať v špeciálnych predajniach so stavebným materiálom (stavebniny). Pri nedodržaní pokynov nepreberajú výrobcovia/predaja a dodávateľa zodpovednosť za vzniknuté škody.

Vigyázat! Szerelés előtt a falüreltet fel kell vizsgálni meg. A mellékelt univerzális típusú falazathoz használható mint például beton/tégla. A fal típusa nem használható könnyű építőkövekhez, üreg tégla, gipszkarton lapokhoz vagy más lávázás építményekhez. Ezekhez a falüreltekhez csak speciális típusú falazathoz, melyek szaküzletekben (barkácsruházakban) beszerezhetőek. Fentiek figyelmét kívüli hagyása esetén a gyártó/kereskedő vagy forgalmazó nem vállal felelősséget.

5.

