

A	B	C (mm)	D	
1	S228-006	604	192	3/3
2	S228-010	596	604	3/3
3	S228-116	758	431	1/3
4	S228-117	758	431	1/3
5	S228-118	666,5	411	1/3
6	S228-119	666,5	411	1/3
7	S228-206	1955	431	2/3
8	S228-319	1923	411	2/3
9	S228-320	646	400	1/3
10	S228-405	598	60	3/3
11	S228-531	147	100	3/3
12	S228-5518	2000	80	2/3
13	S228-5519	1840	80	2/3
14	S228-5520	1920	40	2/3
15	S228-5537	756	80	2/3
16	S228-5538	756	80	2/3
17	S228-5539	431	80	2/3
18	S228-5540	766	58	2/3
19	S228-5541	756	58	2/3
20	S228-5542	315	80	2/3
21	S228-9902	686	659	3/3
22	S228-9903	686	615	3/3
23	WSP-955	568	358	3/3
24	WSQ4-505	350	140	1/3
25	WSQ4-506	350	140	1/3
26	WTQ-5054	558	127	3/3

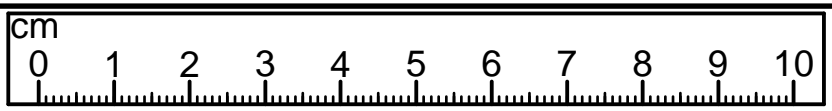

4x a132	2x a133	4x b43	5x c280	8x d1	4x d36	10x e1	8x e2	24 e3	20x e22	33x f1	16x f13	12x f25
10x j30	8x k1	2x k101	21x l1	18x l2	10x n108	1x n14	1x p17	3x p25	3x p35	20x p38	16x p51	5x p8
10x p55	4x p79	18x r1	12x r15	30x r42	3x t35	3x W117L	3x W117P	1x z1	10x s1	8x s2	4x o21	1x f35

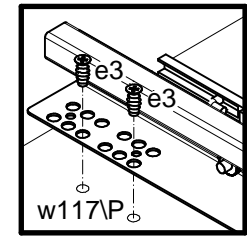

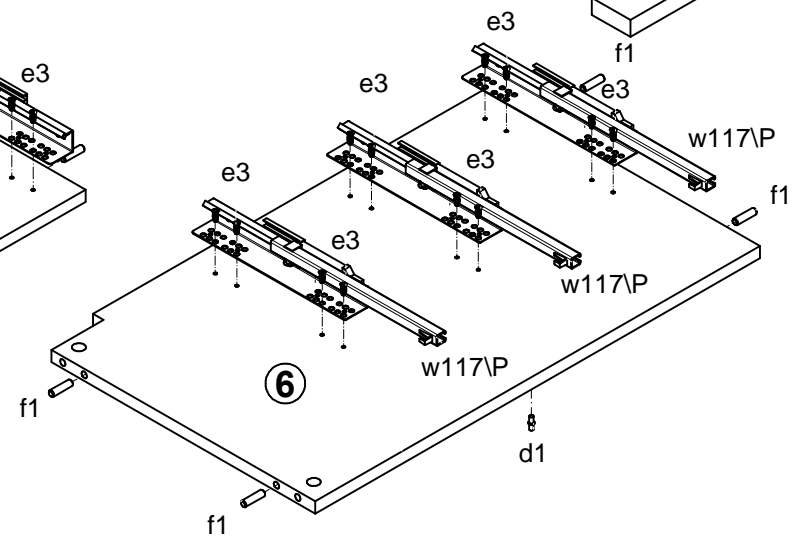
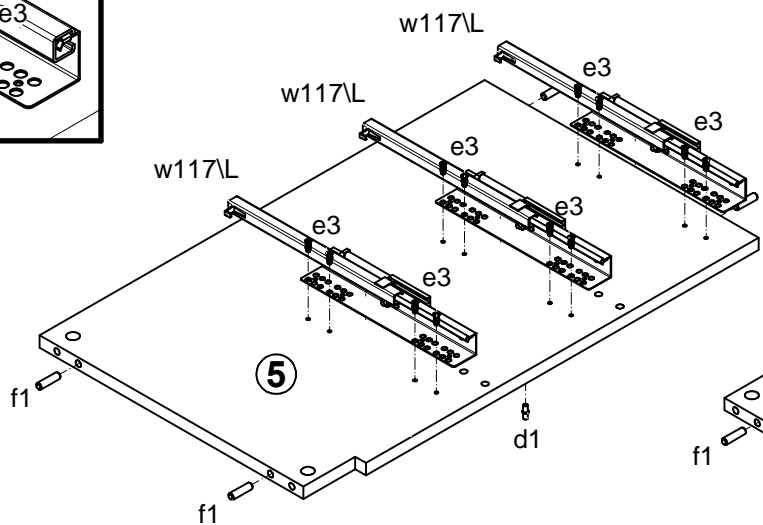
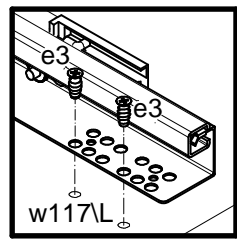
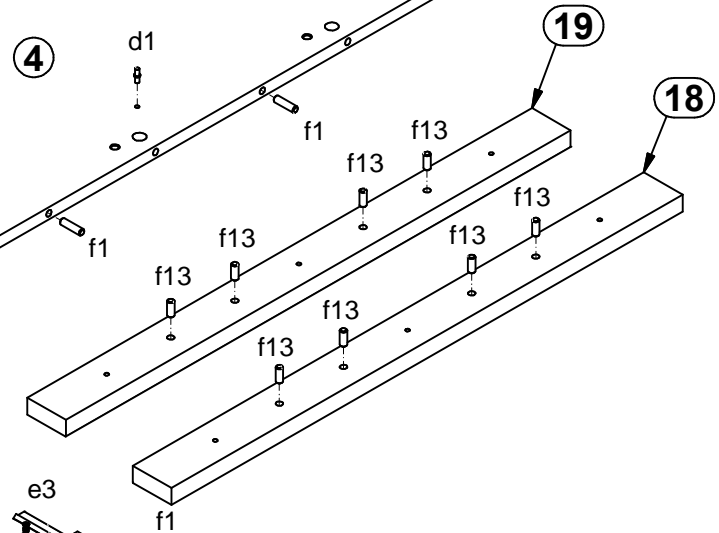
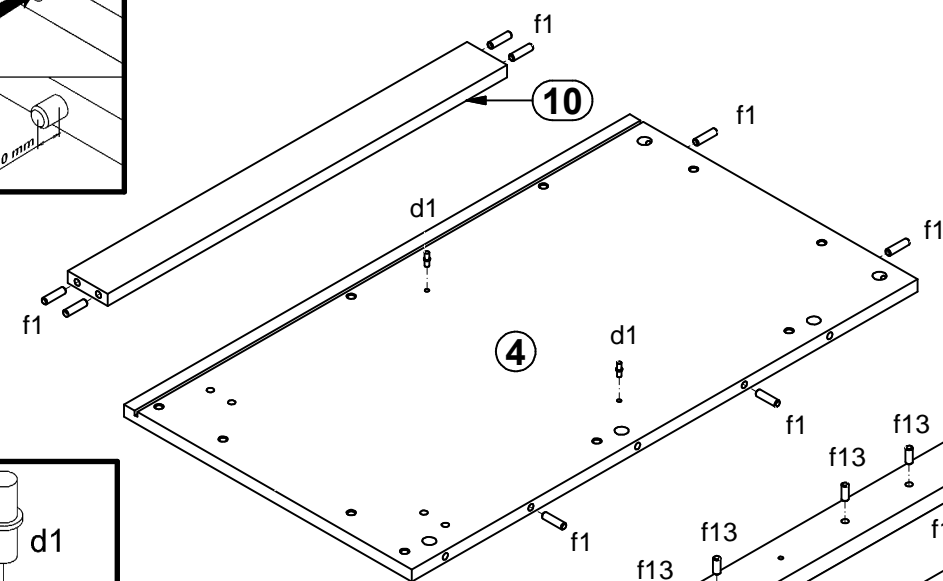
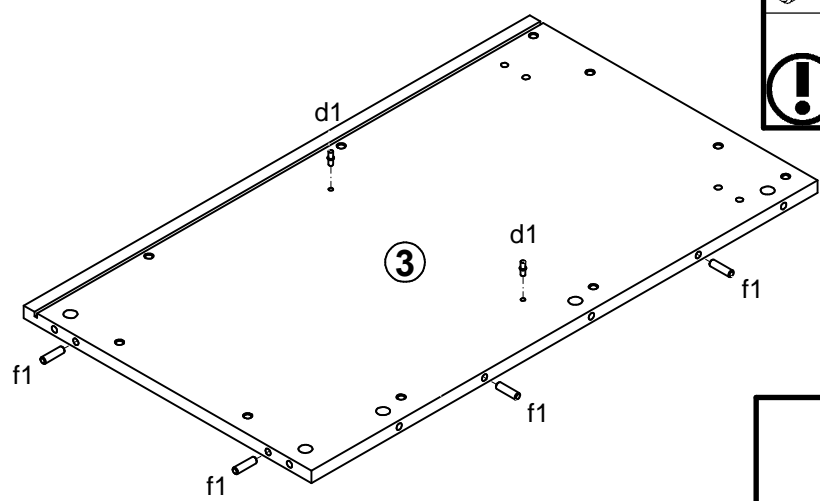
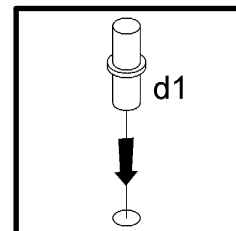
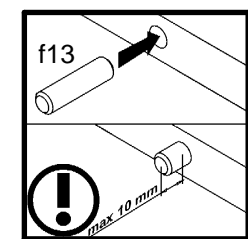
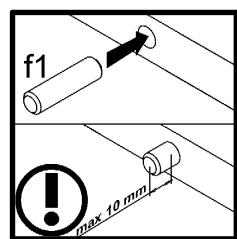
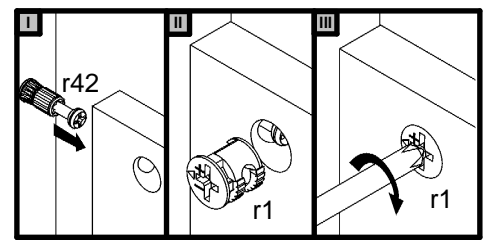
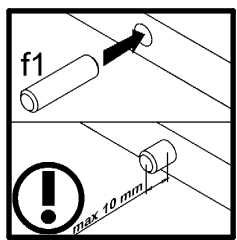
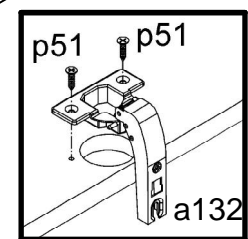
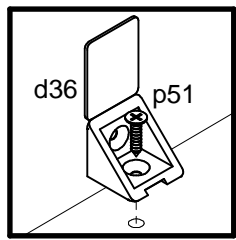
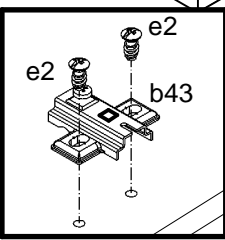
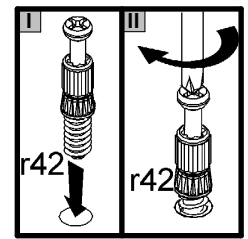
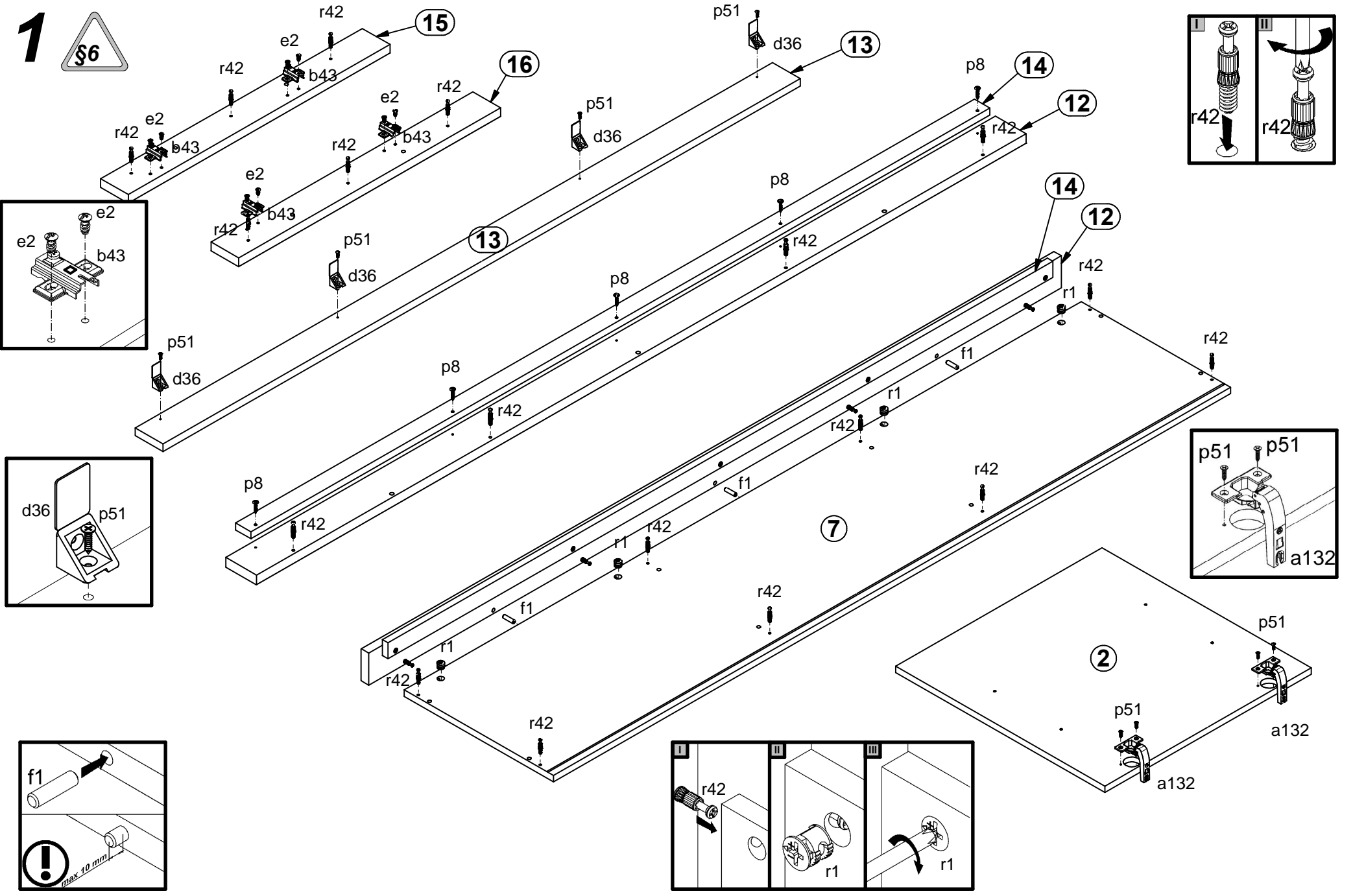

2

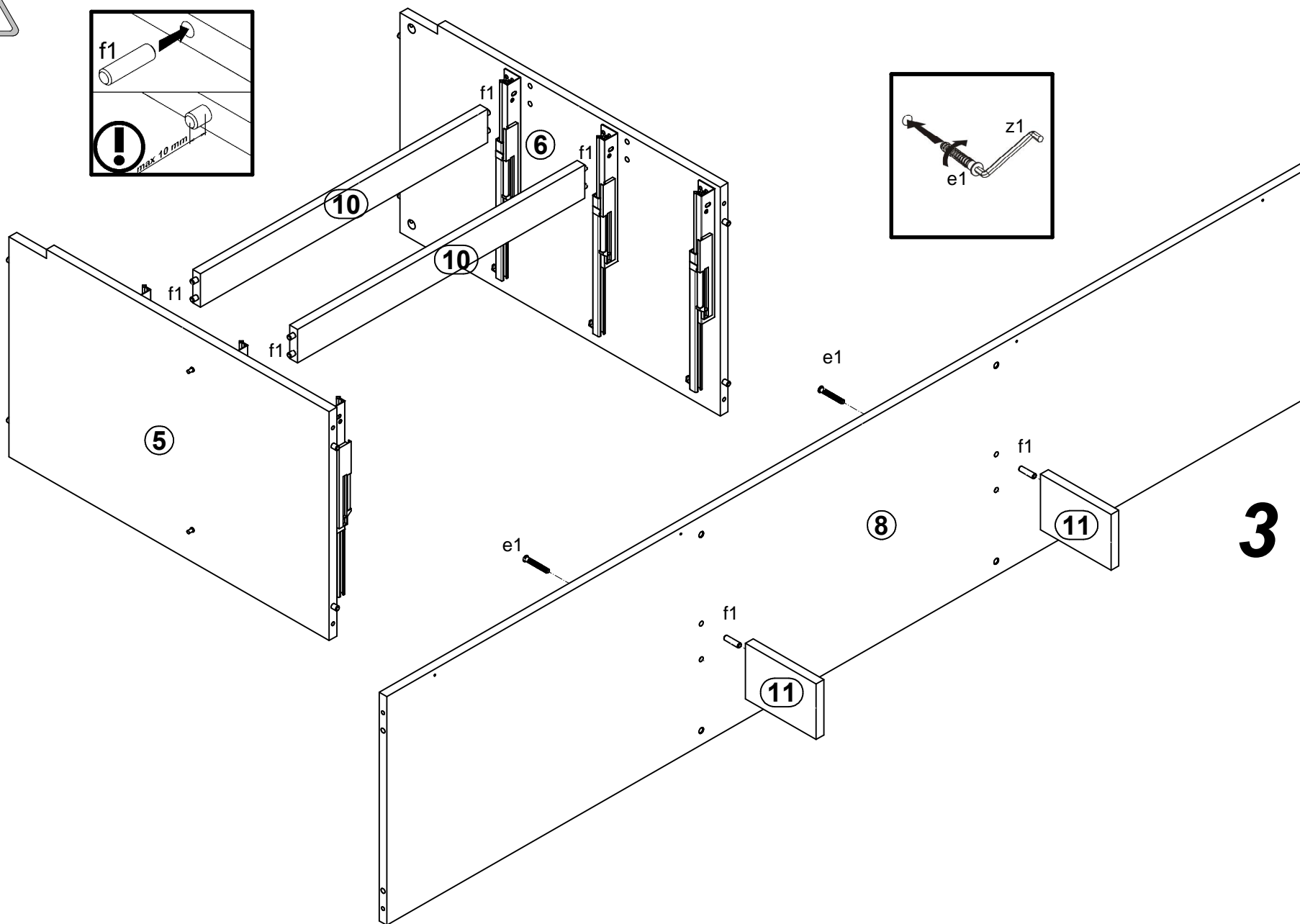
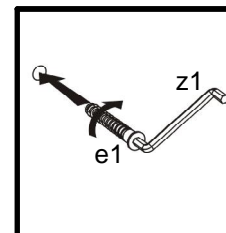
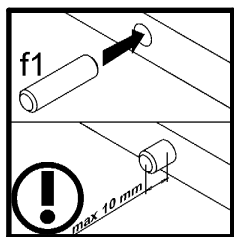



4

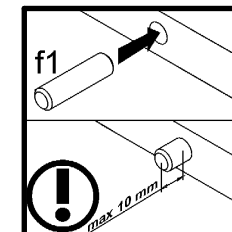
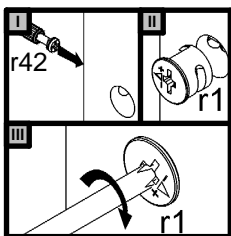
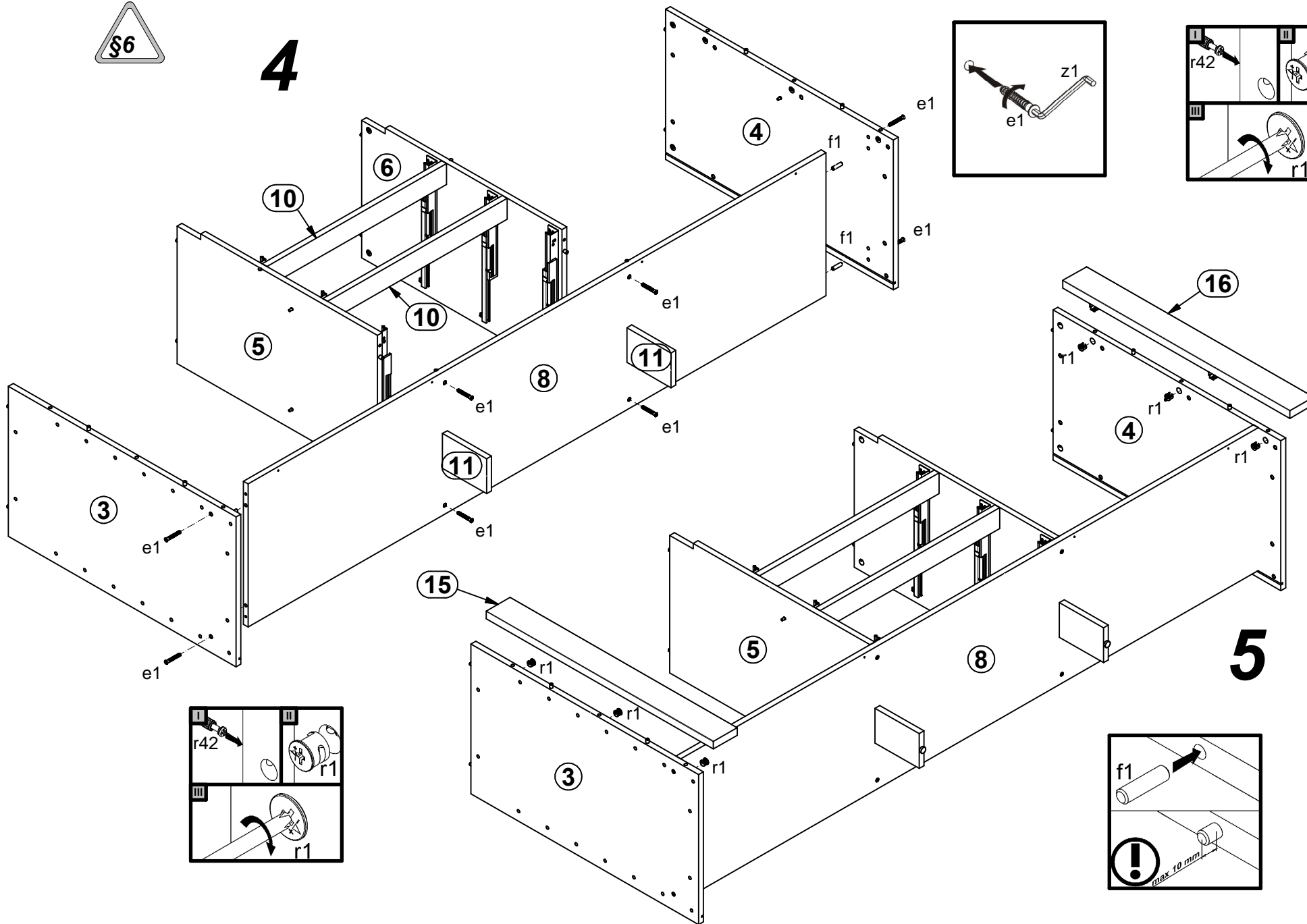
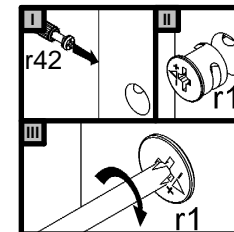
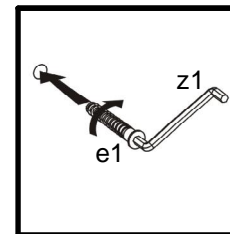

5

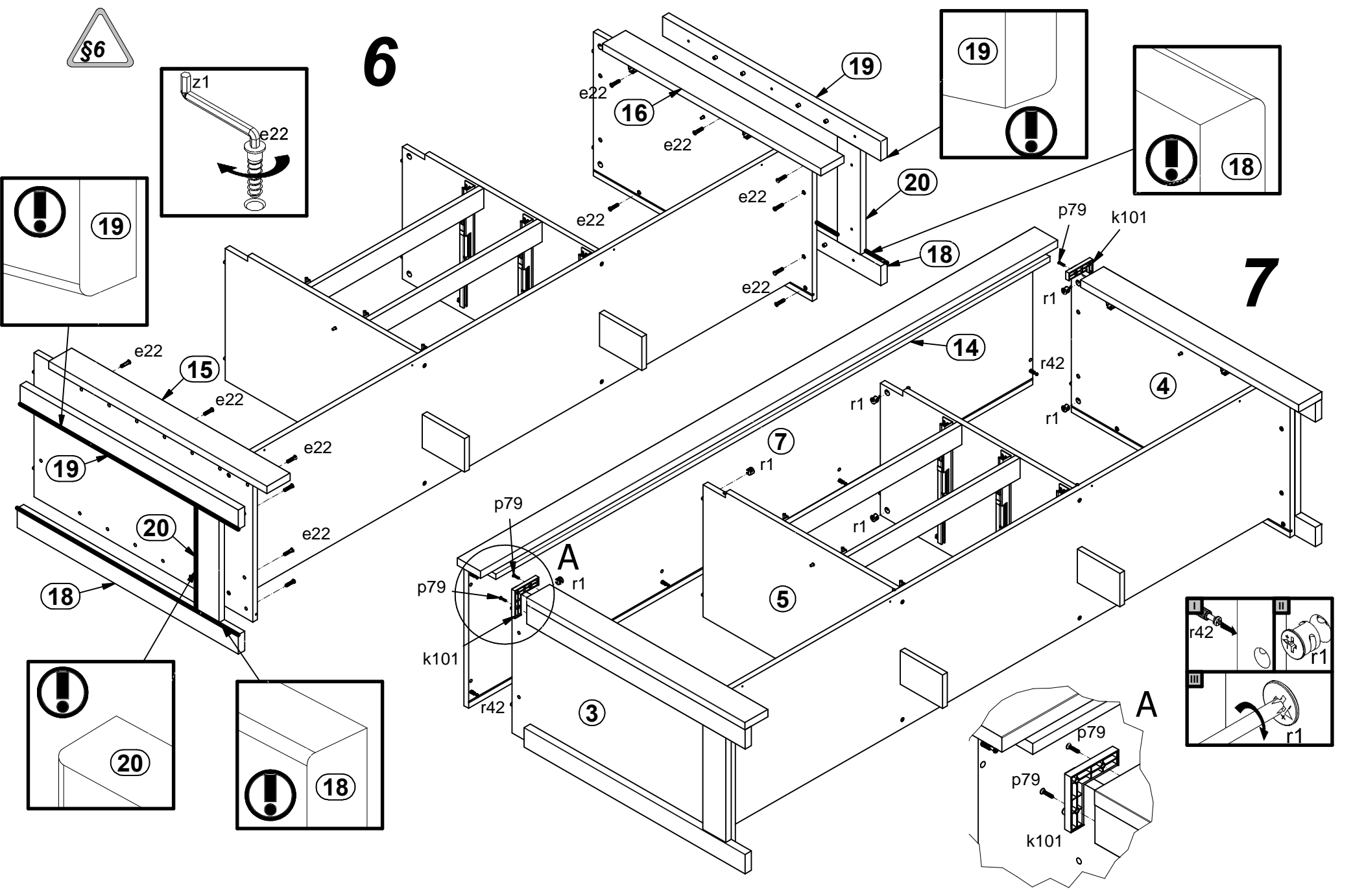

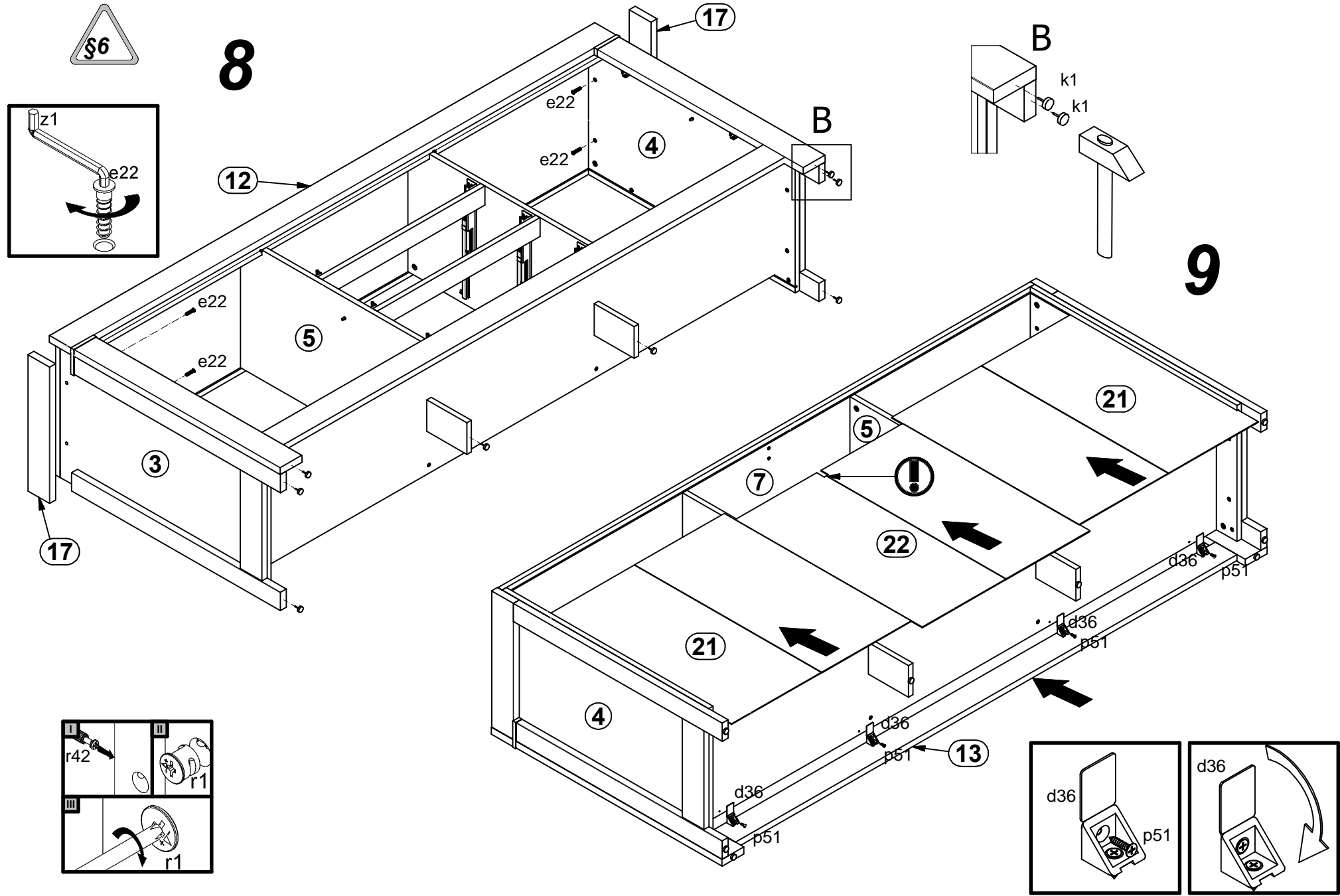

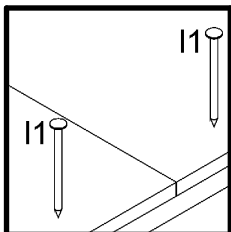

10

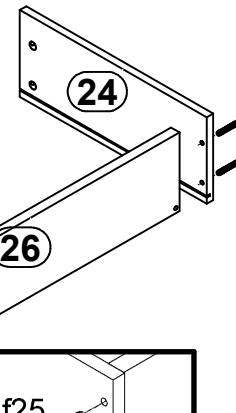
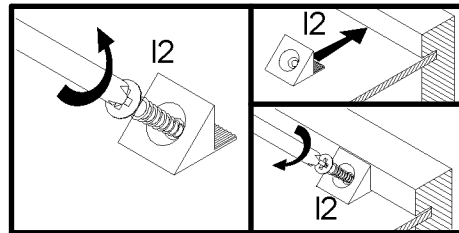
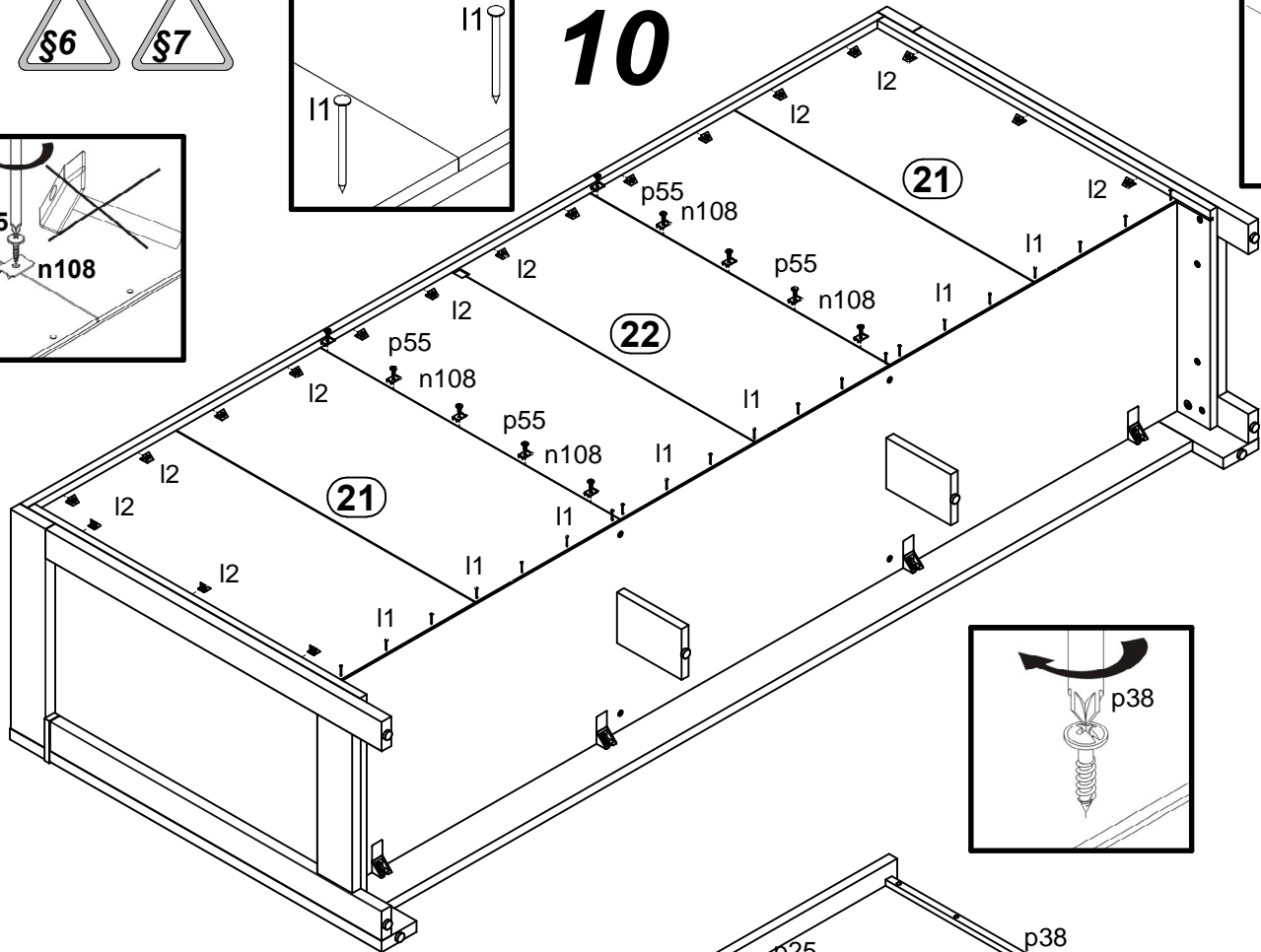
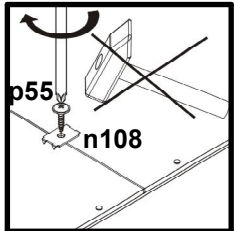

11

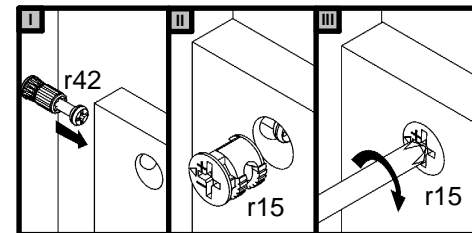
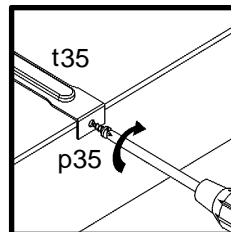
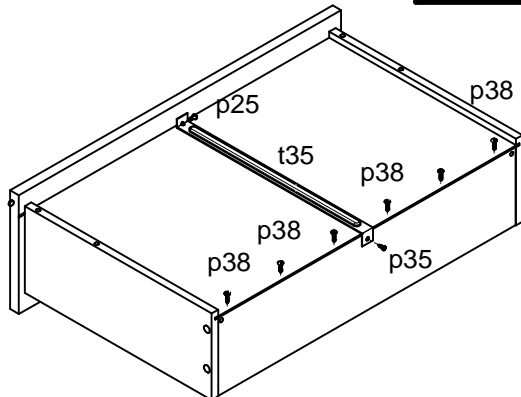
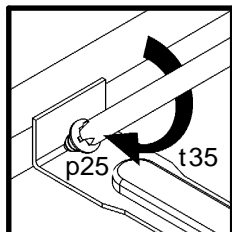
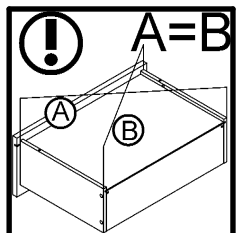
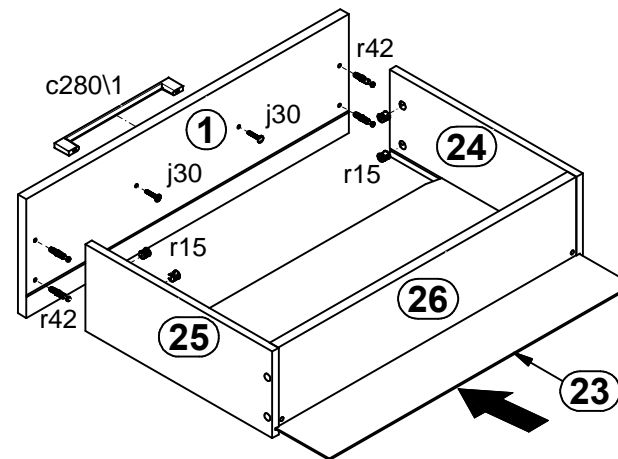
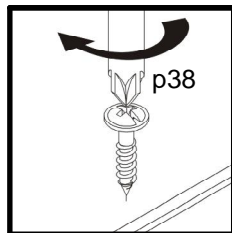
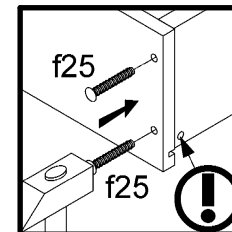

12

