

# NÁVOD NA MONTÁŽ CT-609

30 min  2 x

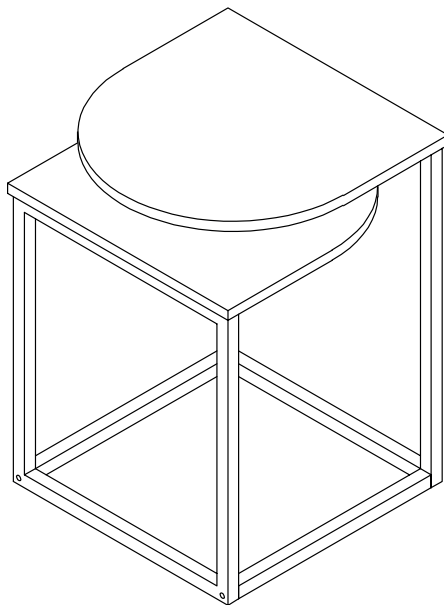

## MONTÁŽNÍ POKYNY

1. Pečlivě ověřte, zda díly před montáží nechybí nebo nejsou poškozené.
2. Při montáži dbejte na přítomnost dětí, aby nedošlo k vdechnutí, spolknutí malých dílů nebo poranění.
3. Šrouby během instalace neutahujte. Po instalaci všech šroubů je rovnoměrně utáhněte.

## POKYNY K POUŽÍVÁNÍ

1. K čištění používejte pouze měkký hadřík a prostředky k tomu určené.
2. Nepoužívejte na místech s nadměrným výskytem vlhkosti nebo teploty.
3. Na stůl nestoupejte, nesedejte ani ho nepřetěžujte.
4. Nepoužívejte stůl k jinému účelu, než je určen.



## MONTÁŽNE POKYNY

1. Starostlivo overte, či diely pred montážou nechybajú alebo nie sú poškodené.
2. Pri montáži dajte pozor na prítomnosť detí, aby nedošlo k vdychnutiu, prehltnutiu malých dielov alebo poraneniu.
3. Skrutky počas inštalácie neufahujte. Po inštalácii všetkých skrutiek ich rovnomerne utiahnite.

## POKYNY NA POUŽÍVANIE

1. Na čistenie používajte iba mäkkú handričku a prostriedky na to určené.
2. Nepoužívajte na miestach s nadmerným výskytom vlhkosti alebo teploty.
3. Na stôl nestúpajte, nesedajte a ani ho nepreťažujte.
4. Nepoužívajte stôl na iný účel, než je určený.

1 x 1

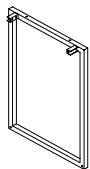

2 x 1

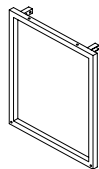

3 x 1

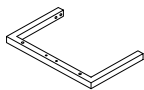

4 x 1

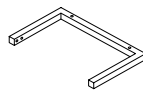

5 x 1

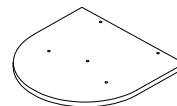

6 x 1

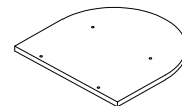

7 x 2

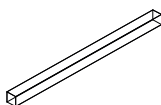

8 x 1

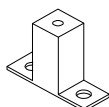

A x 5

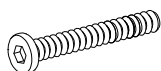

B x 8



C x 10



D x 4



E x 1

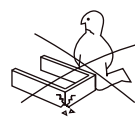
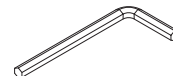

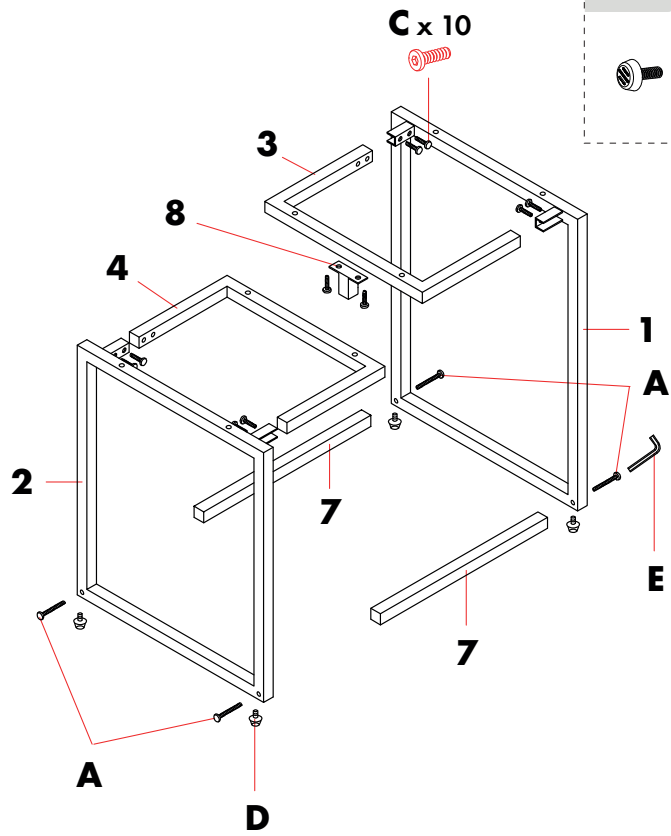
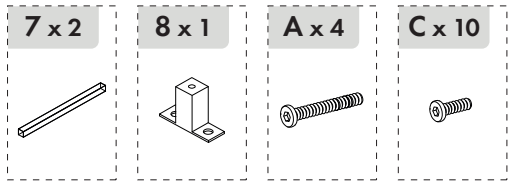
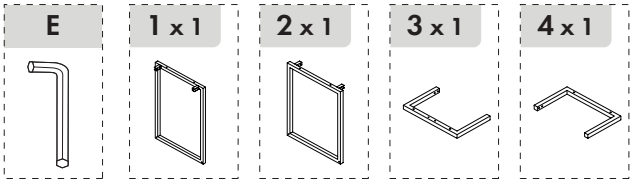
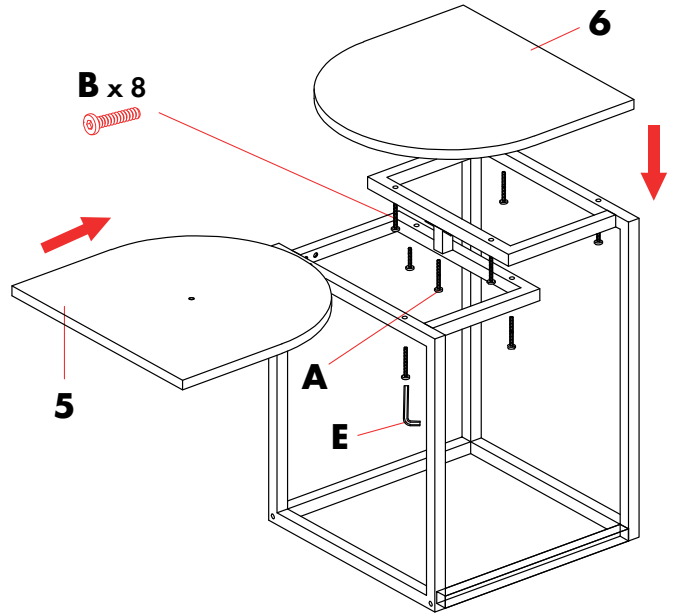
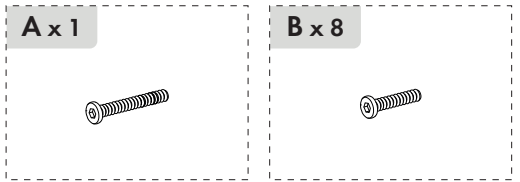
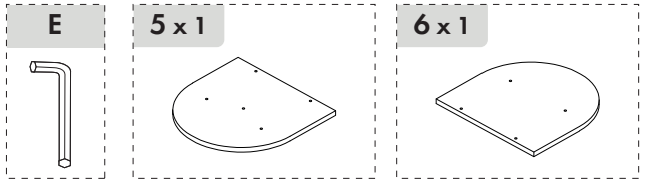
**1****2****3**