

LUGO 2D LU2

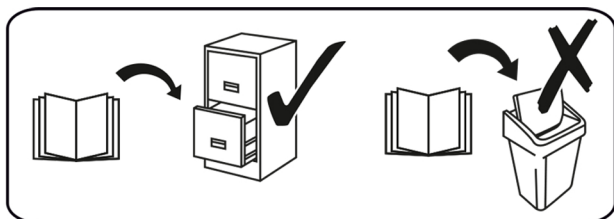

CZ Povrch nábytku čistíte pouze přípravky určenými k ošetřování nábytku.

SK Povrch nábytku čistíte iba prostriedkami určenými na ošetrovanie nábytku.

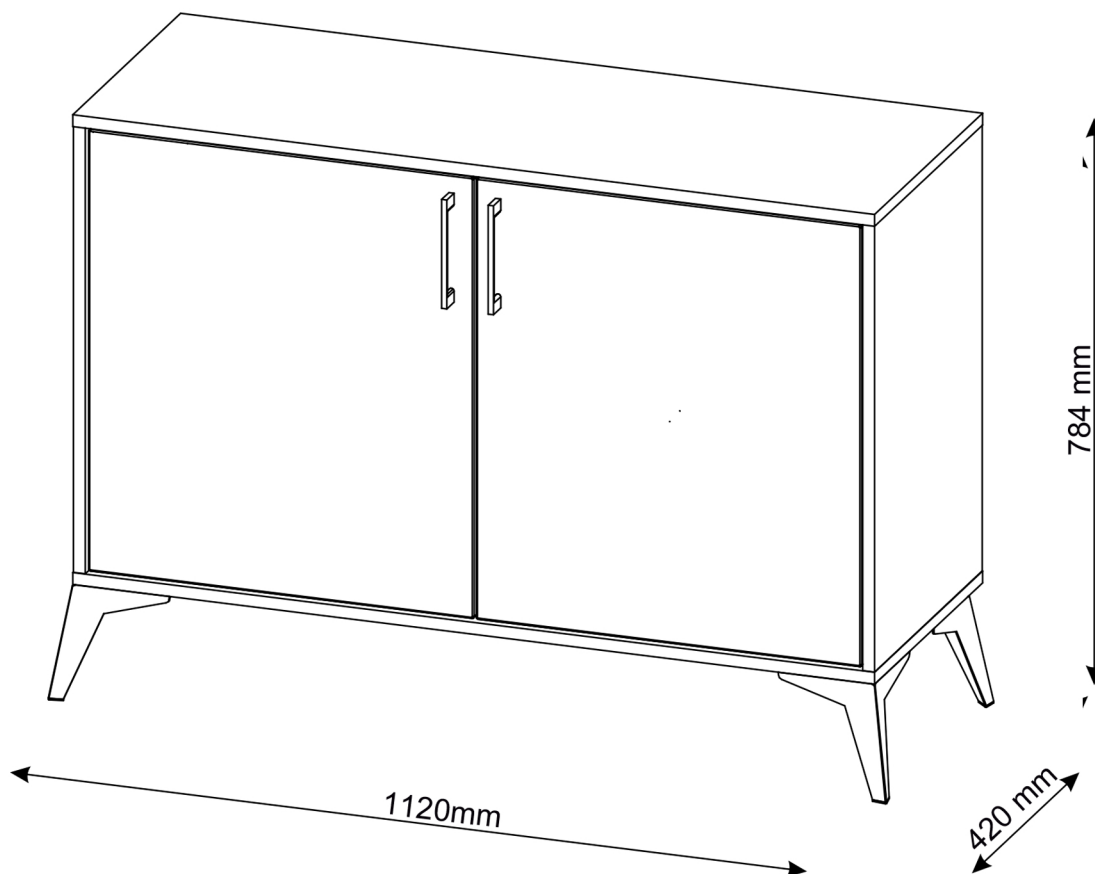
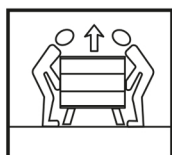







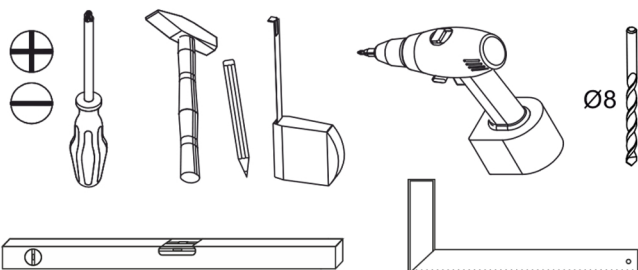

RO Suprafata ei trebuie să fie curătată numai cu substanțe destinate pentru curățarea mobilei.



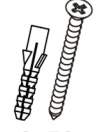

HU A bűtor felületét csak bútórápoló szerekkel szabad tisztítani.

HR Površinu namještaja treba čistiti samo sredstvima za njegu namještaja.

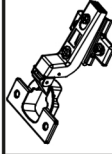
SI Površino pohištva čistite samo s sredstvi za nego pohištva.

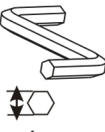

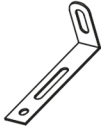
A0  Ø8x30 x12	B4  x2	B1  Ø7x50 x6	C2  x6	C4  x6	C7  16 mm x6	D4  3.5x16 x19	D5  3.5x16 x26	E0  8x50 x2	H2  4x22 x4	J5  x4
--	---	--	---	---	--	--	--	---	---	---

K  4mm x1	L15  x2	M1  x14	P0  x2	Q0  x8	T20  x4
--	--	--	---	---	--

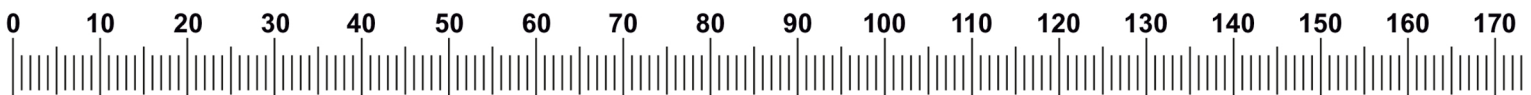
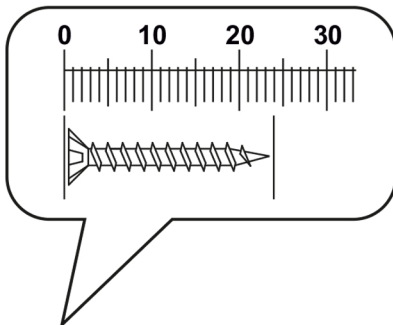
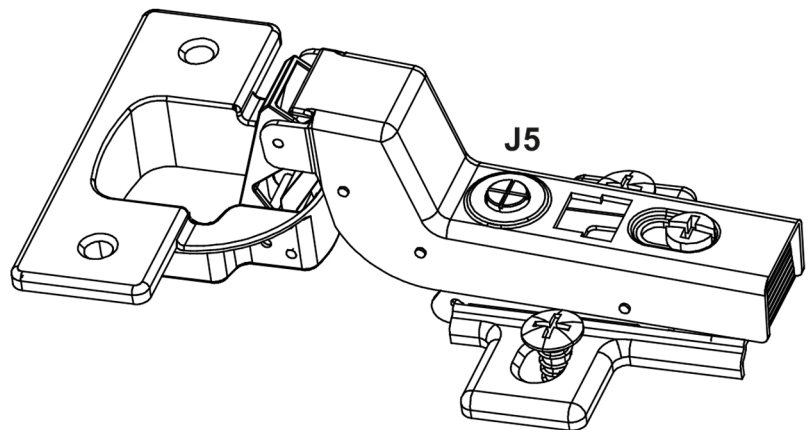
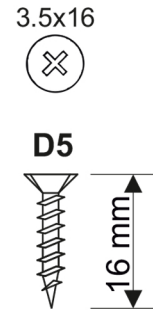
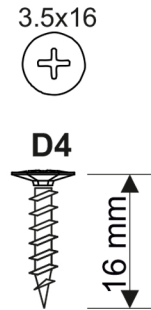
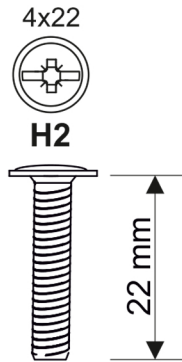

①	1082	400	16	x1	2/2
②	1082	400	16	x1	2/2
③	602	399	16	x1	1/2
④	602	399	16	x1	1/2
⑤	602	358	16	x1	1/2
⑥	515	350	16	x2	1/2
⑦	596	520	18	x1	1/2
⑧	596	520	18	x1	1/2
⑨	612	529	3	x2	1/2
					1/2

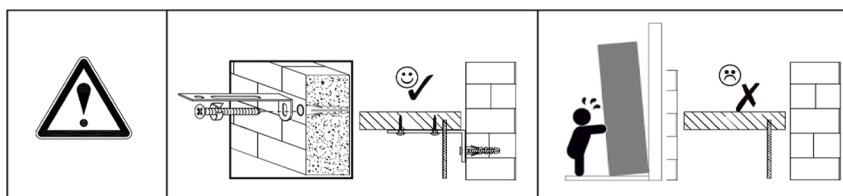
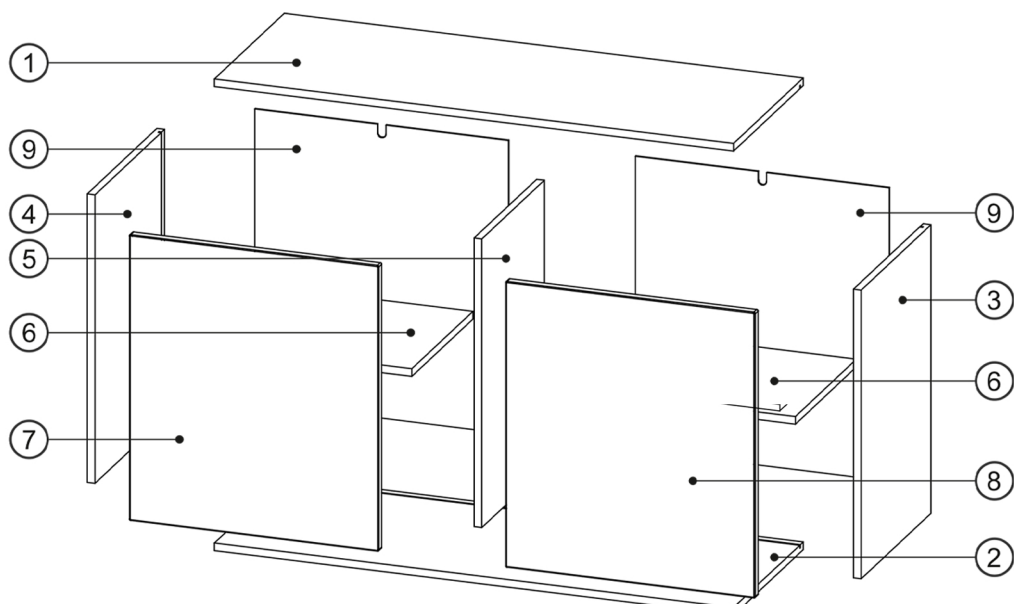

CZ Připevnění ke stěně

Prosím, nesbírejte nábytek, pokud jsou jeho prvky poškozené. Před montáží je nutné pečlivě prohlédnout jednotlivé prvky nábytku. V případě jejich poškození je třeba je nahlásit spolu s fotodokumentací pro posouzení reklamace a přijetí vhodných opatření.

SK Pripevnenie na stenu

Prosím, nezbierajte nábytok, ak sú jeho prvky poškodené. Pred montážou je potrebné dôkladne prezrieť jednotlivé prvky nábytku. V prípade ich poškodenia je potrebné nahlásiť ich spolu s fotodokumentáciou pre posúdenie reklamácie a prijatie nábytku. V prípade ich poškodenia je potrebné nahlásiť ich spolu s fotodokumentáciou pre posúdenie reklamácie a prijatie vhodných opatrení.

RO Atașarea la perete

Vă rugăm să nu colectați mobilier dacă elementele acesteia sunt deteriorate. Înainte de asamblare, este necesar să inspectați cu atenție elementele individuale ale mobilierului. În caz de deteriorare a acestora, trebuie raportat împreună cu documentația foto pentru a lua în considerare reclamația și a lua măsurile corespunzătoare.

HU A falhoz rögzítés

Kérjük, ne gyűjtse össze a bútorokat, ha azok elemei sérültek. Összeszerelés előtt alaposan meg kell vizsgálni a bútor egyes elemeit. Ha megsérülnek, fényképes dokumentációval együtt be kell jelenteni a panasz mérlegelésére és a megfelelő intézkedések megtételére.

HR Montaža na zid



Molimo nemojte skupljati namještaj ako su njegovi dijelovi oštećeni. Prije montaže potrebno je pažljivo pregledati pojedine elemente namještaja. U slučaju oštećenja iste potrebno je prijaviti uz fotodokumentaciju kako bi se reklamacija razmotrila i poduzele odgovarajuće mjere. odgovarajuće mjere.

SI Pritrdite na steno

Ne zbirajte pohištva, če so njegovi elementi poškodovani. Pred montažo je potrebno natančno pregledati posamezne elemente pohištva. V primeru poškodb le-teh je potrebno prijaviti skupaj s fotodokumentacijo, da se reklamacija obravnava in ustrezno ukrepa.

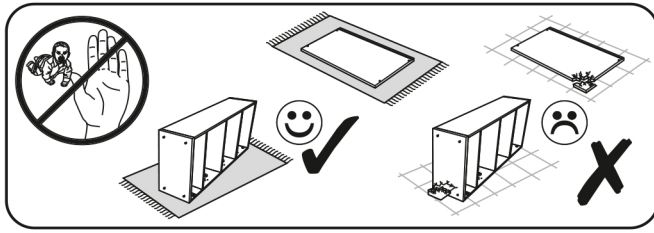
1



A0  Ø8x30 x12	C2  x6	C7  16 mm x6
---	---	--

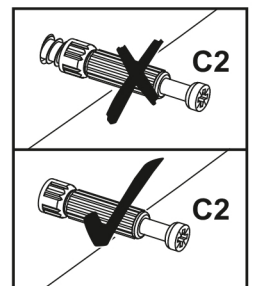
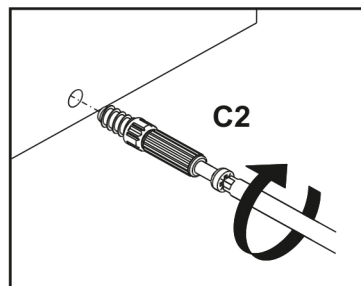
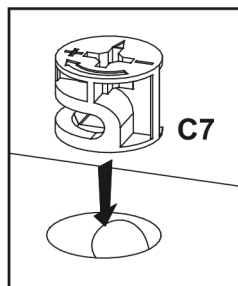
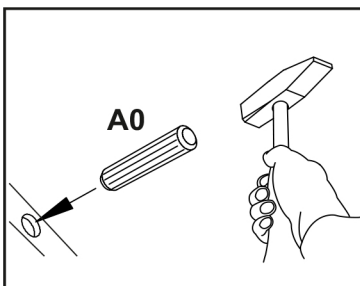
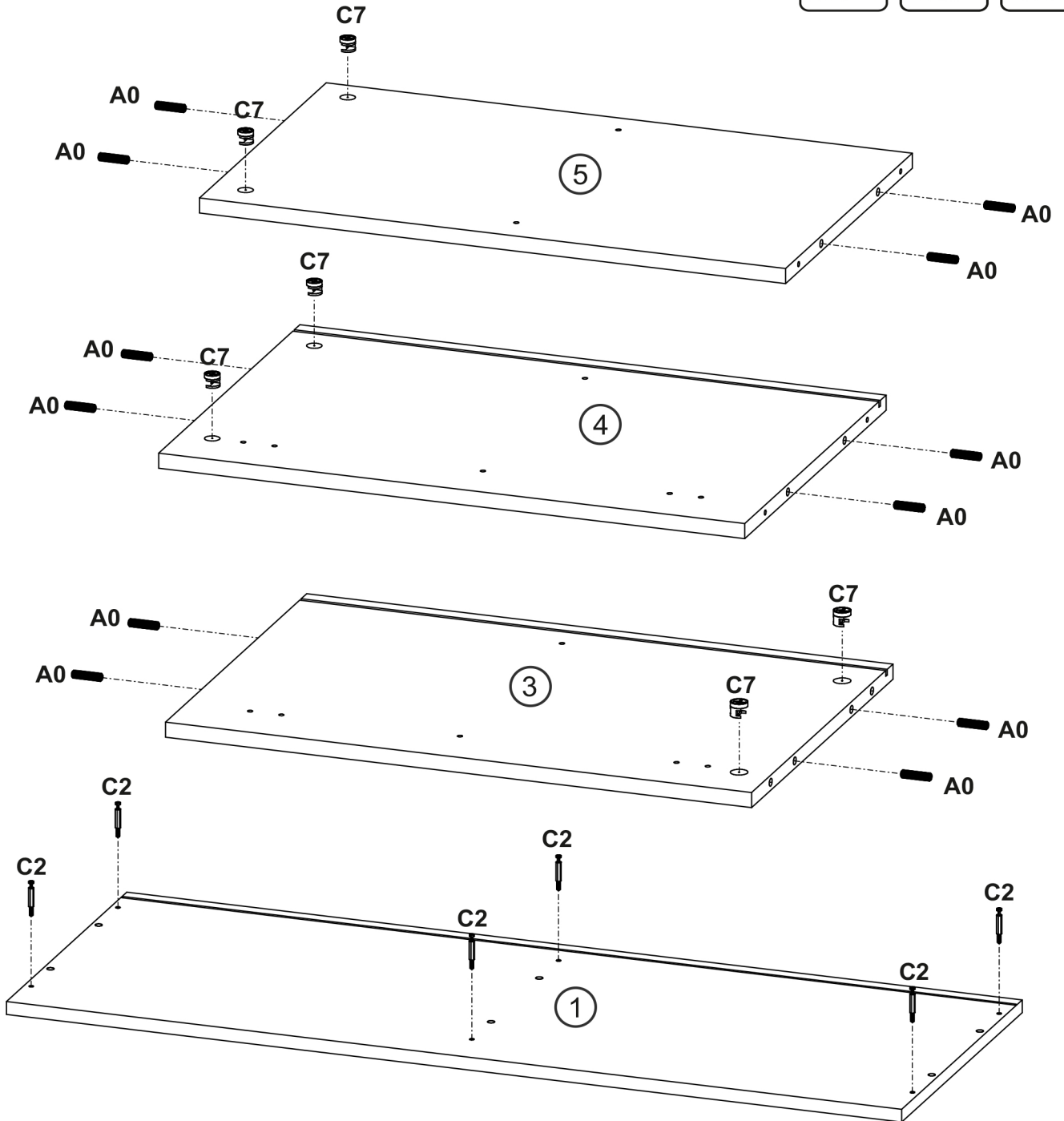

2

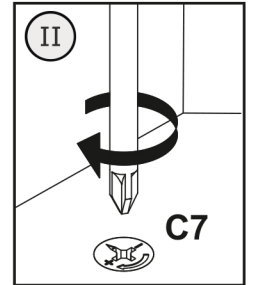
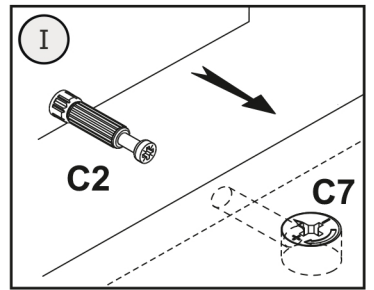
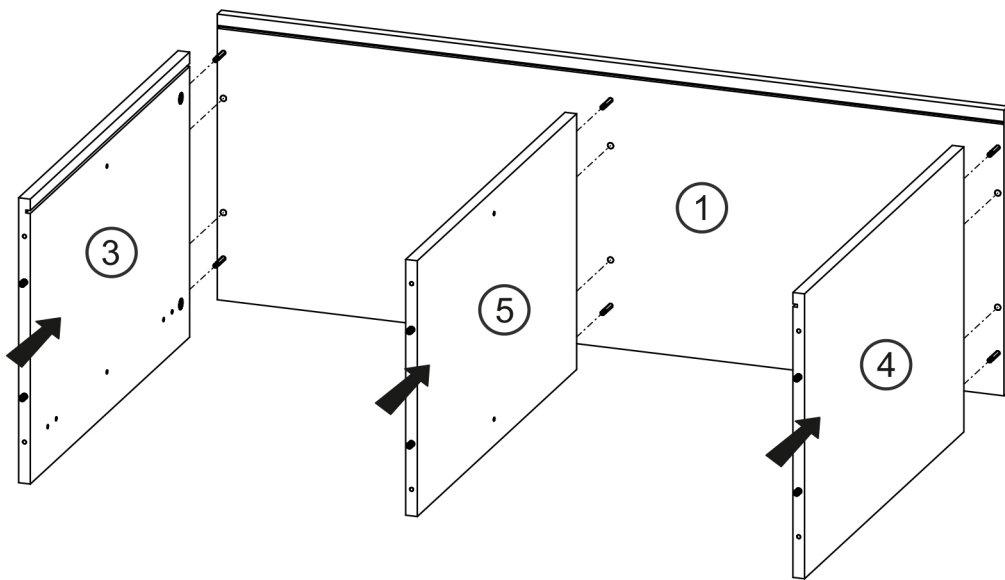

3

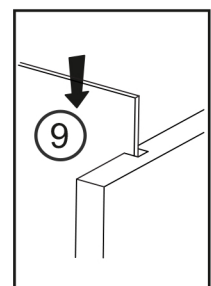
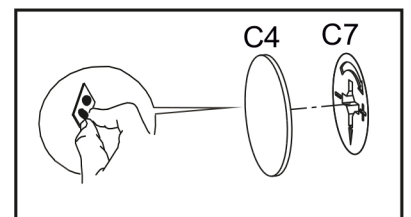
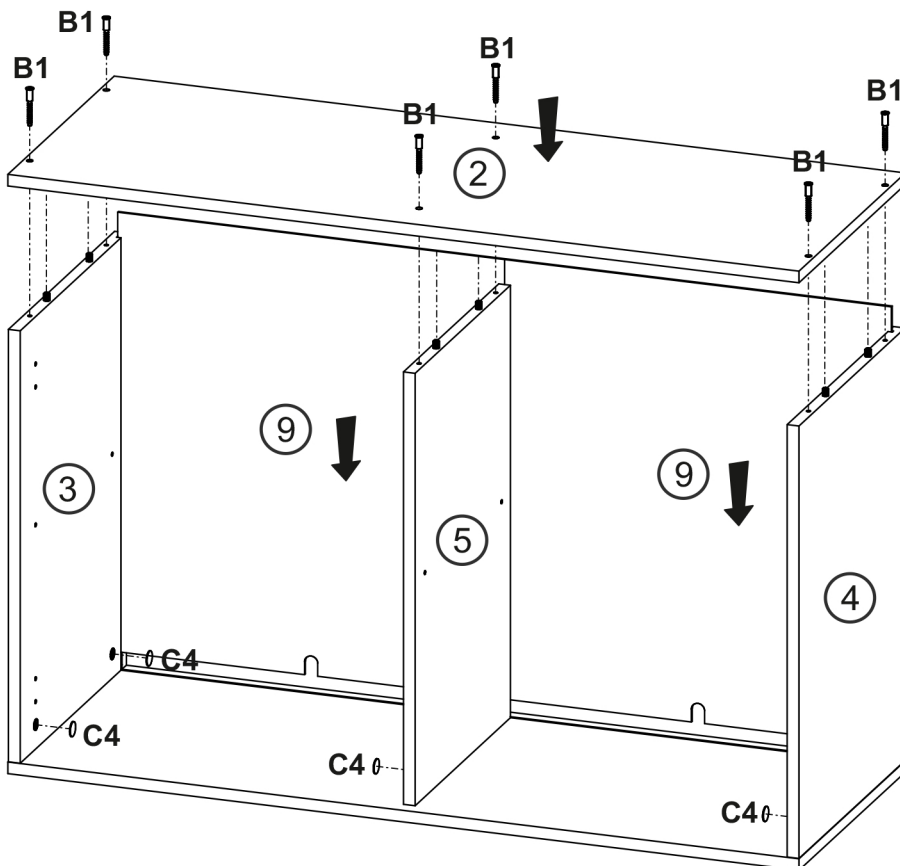
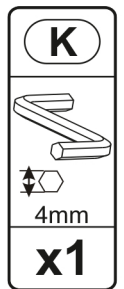
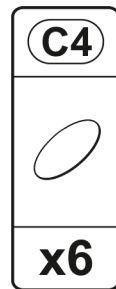
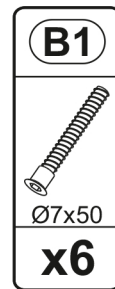
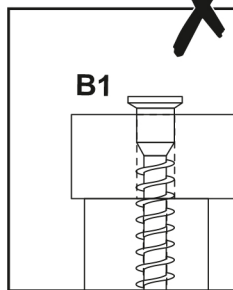
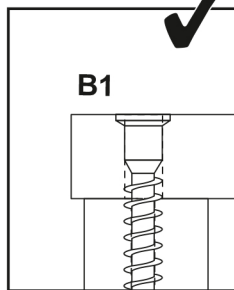
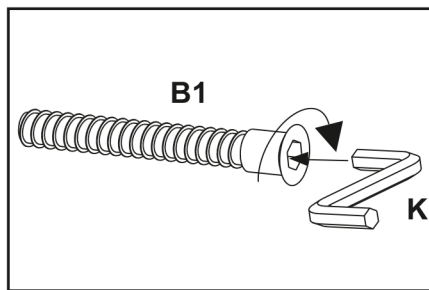

4

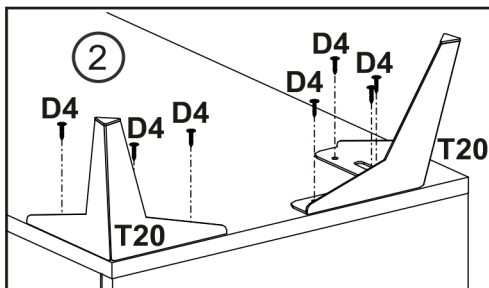

B4	D4	T20
	3.5x16	
x2	x16	x4

3.5x16



3.5x16



D5

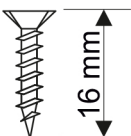

D4

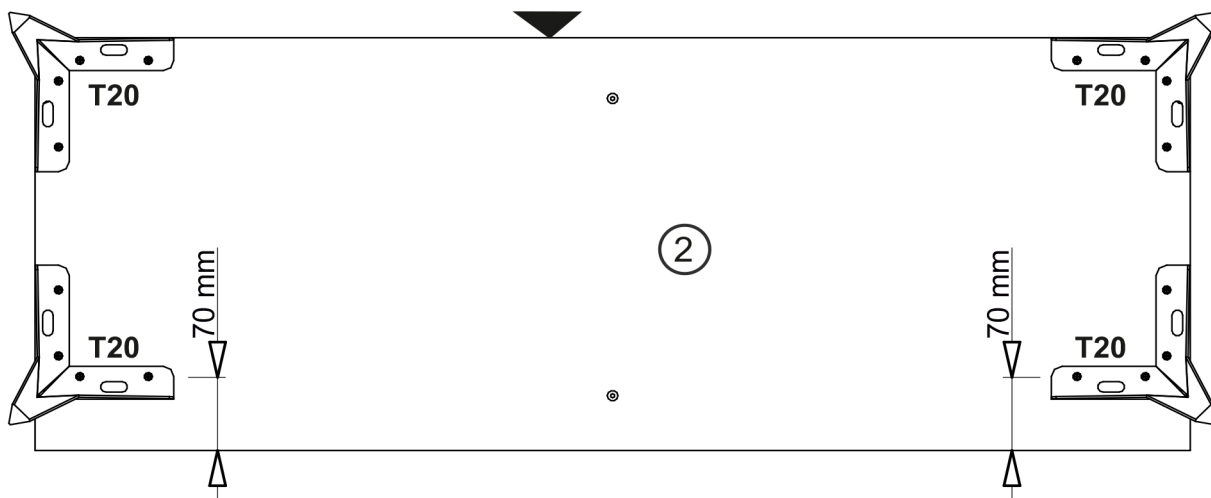
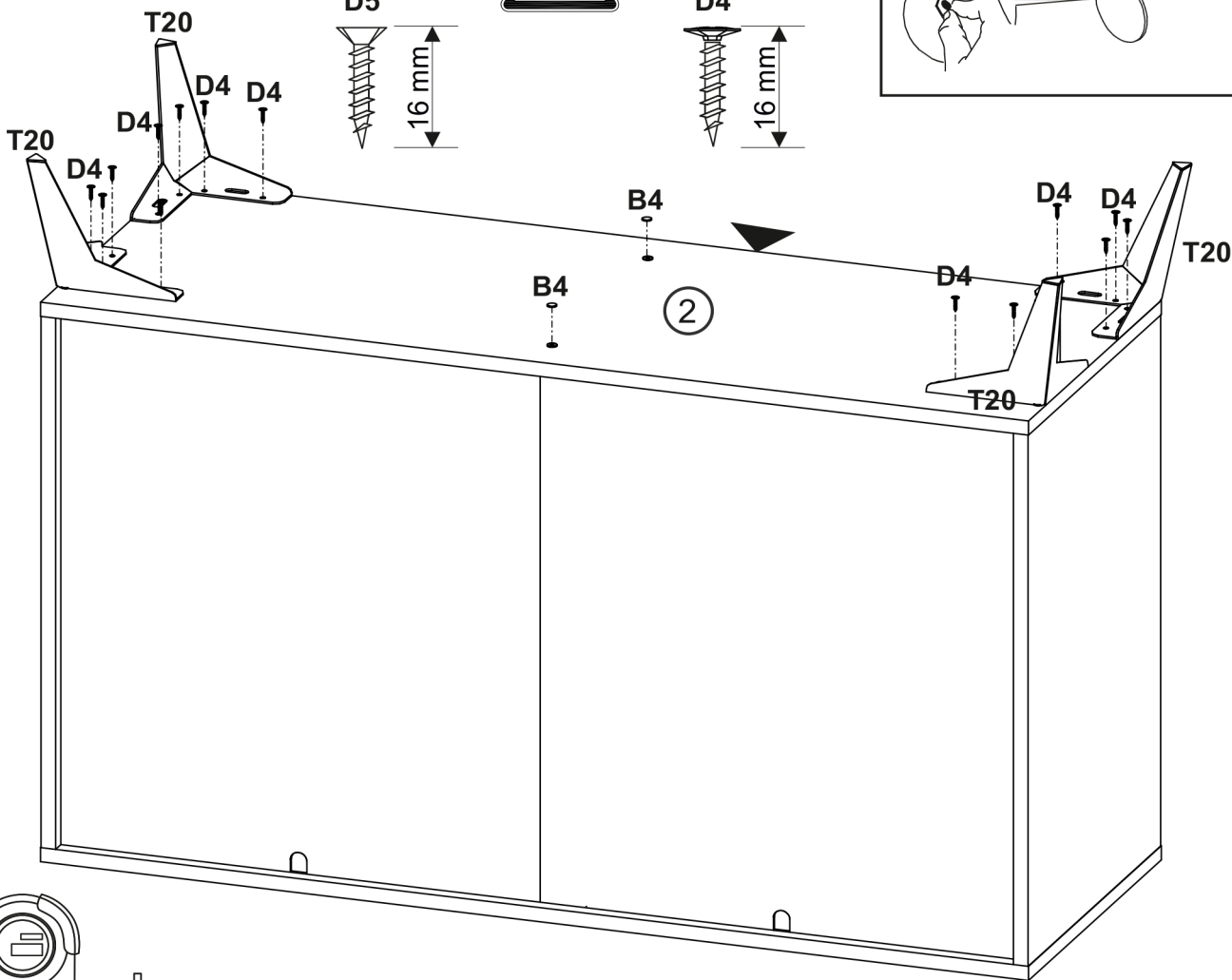
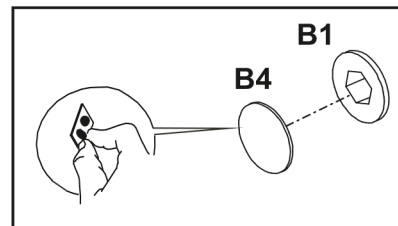
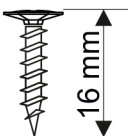

5

3.5x16



D4

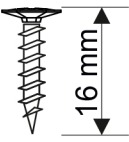

3.5x16



D5

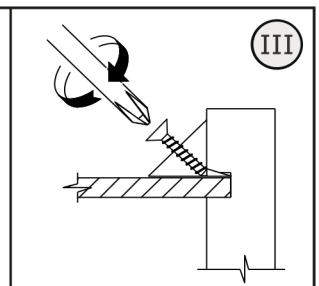
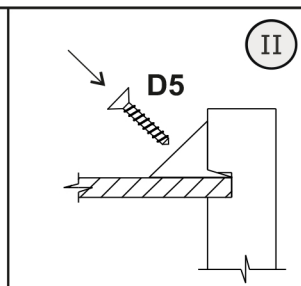
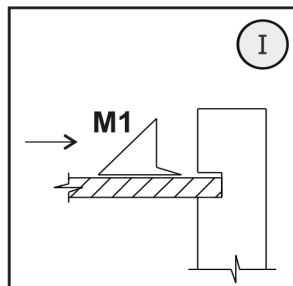
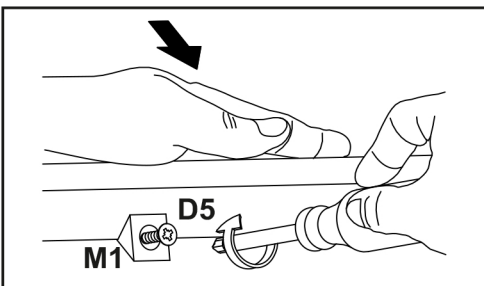
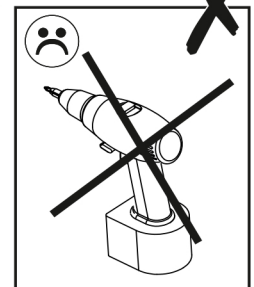
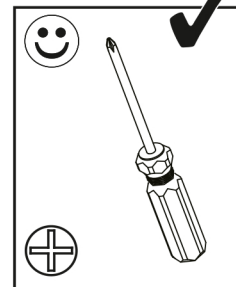
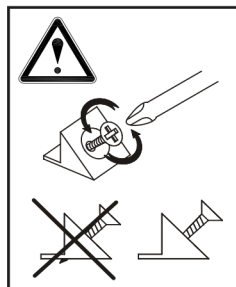
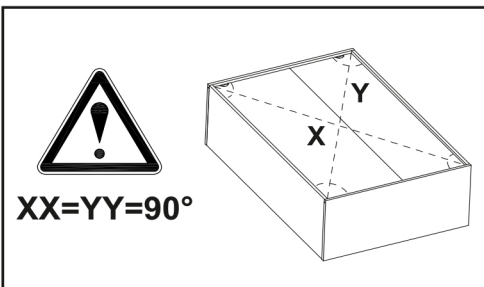
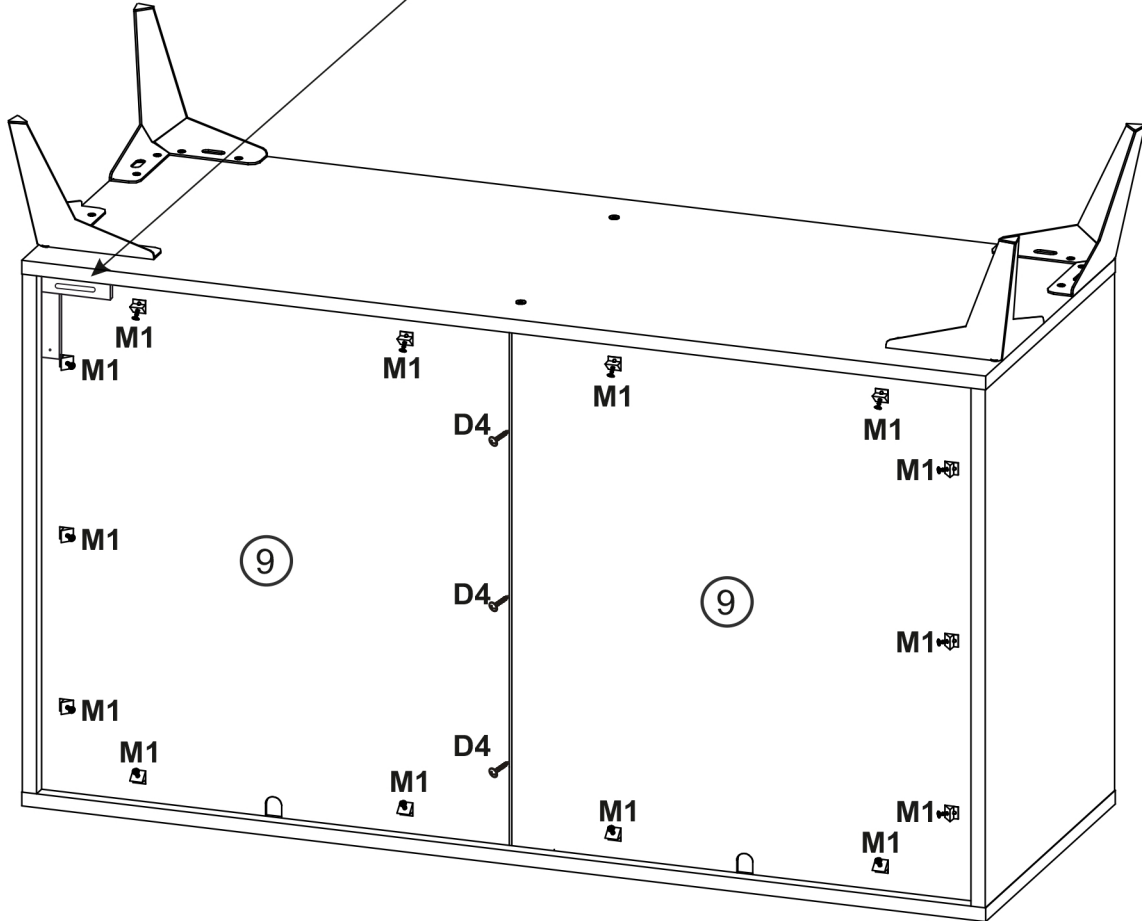
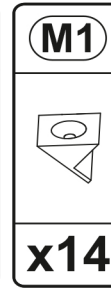
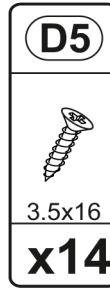
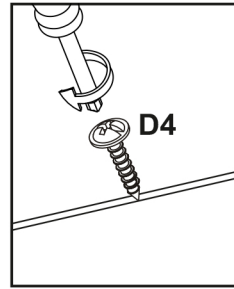
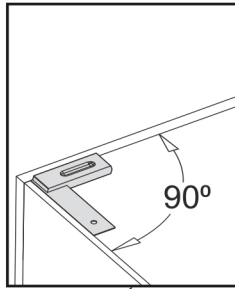
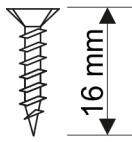



6

3.5x16

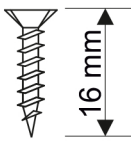

D5

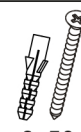
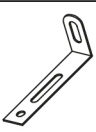

D5	E0	P0
		
3.5x16	8x50	
x4	x2	x2

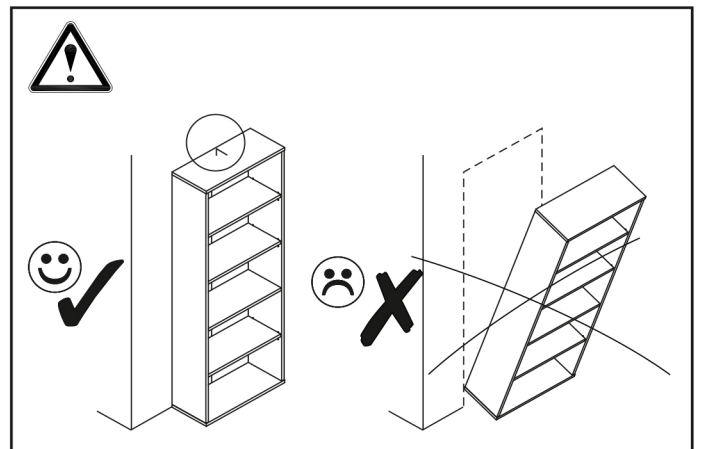
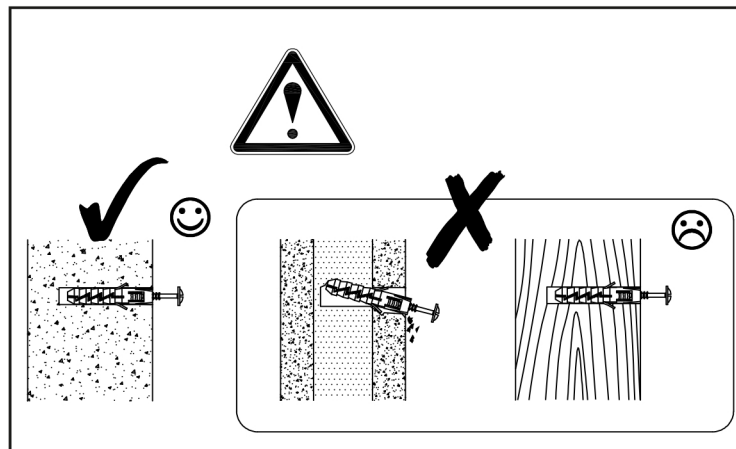
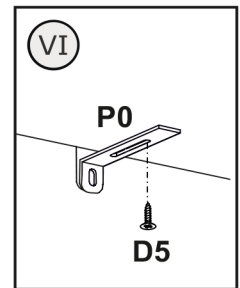
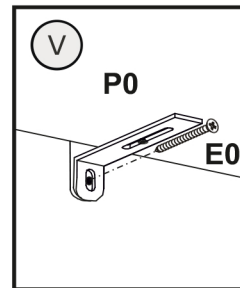
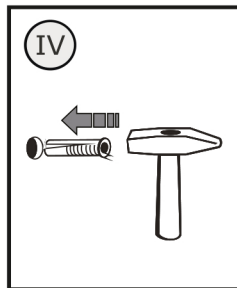
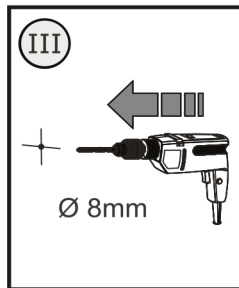
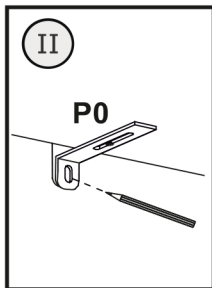
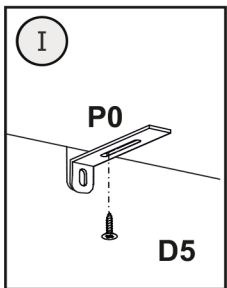
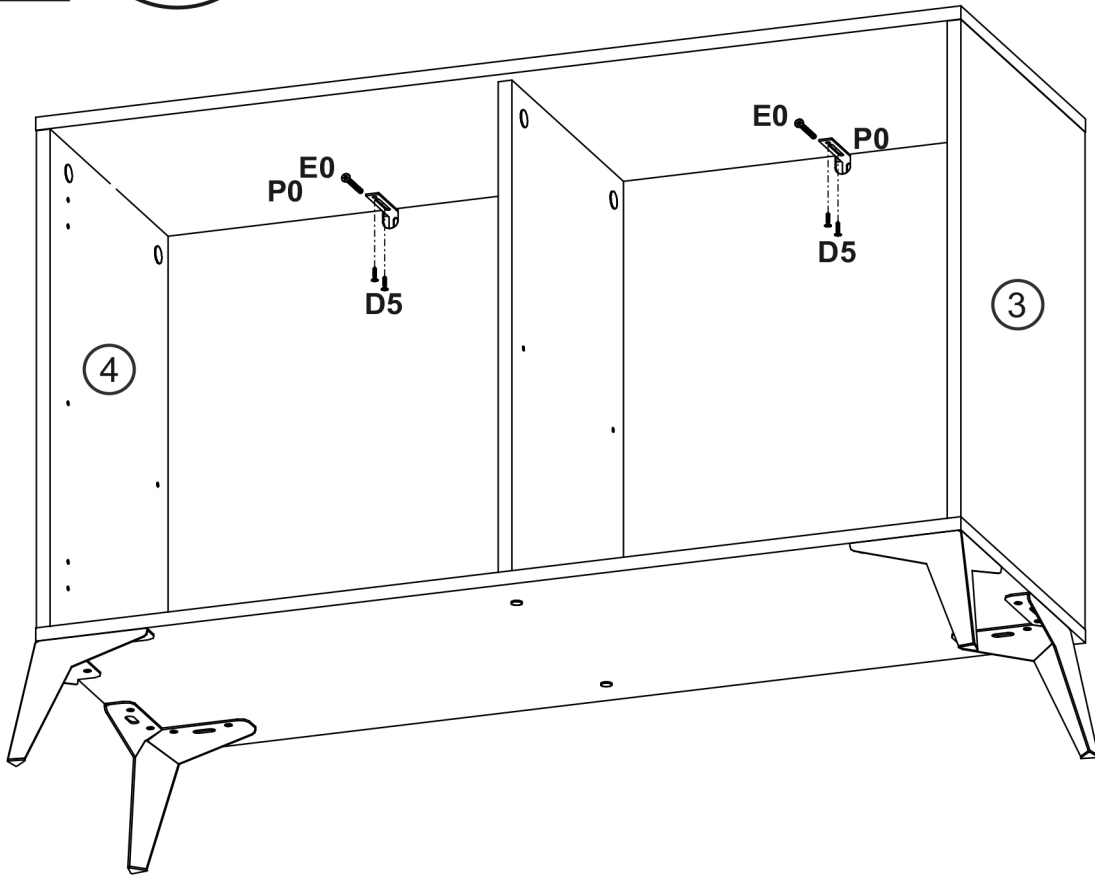
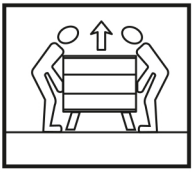

7

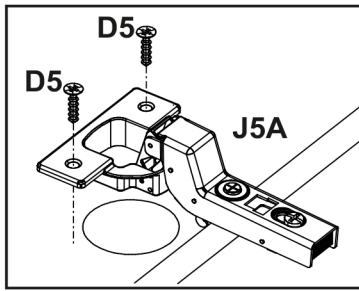
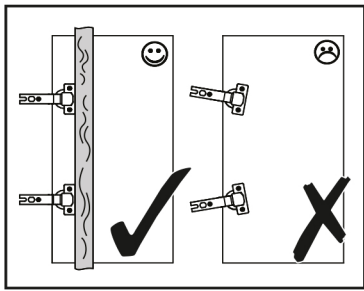

3.5x16



D5

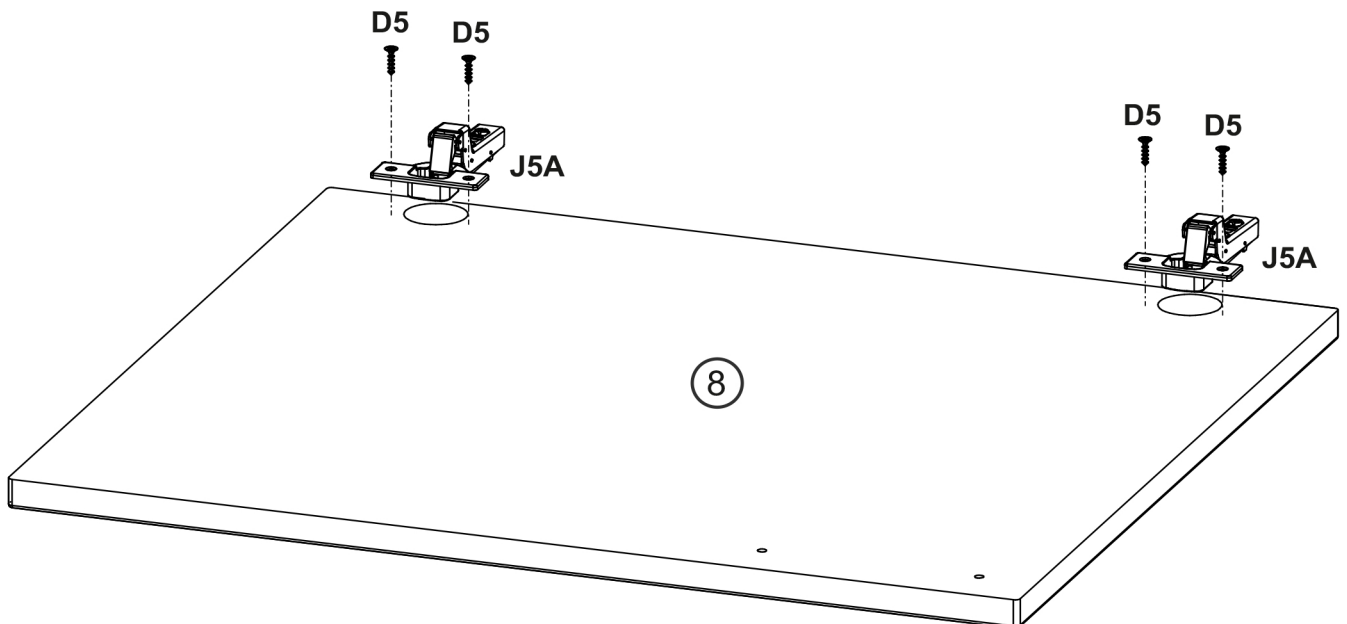
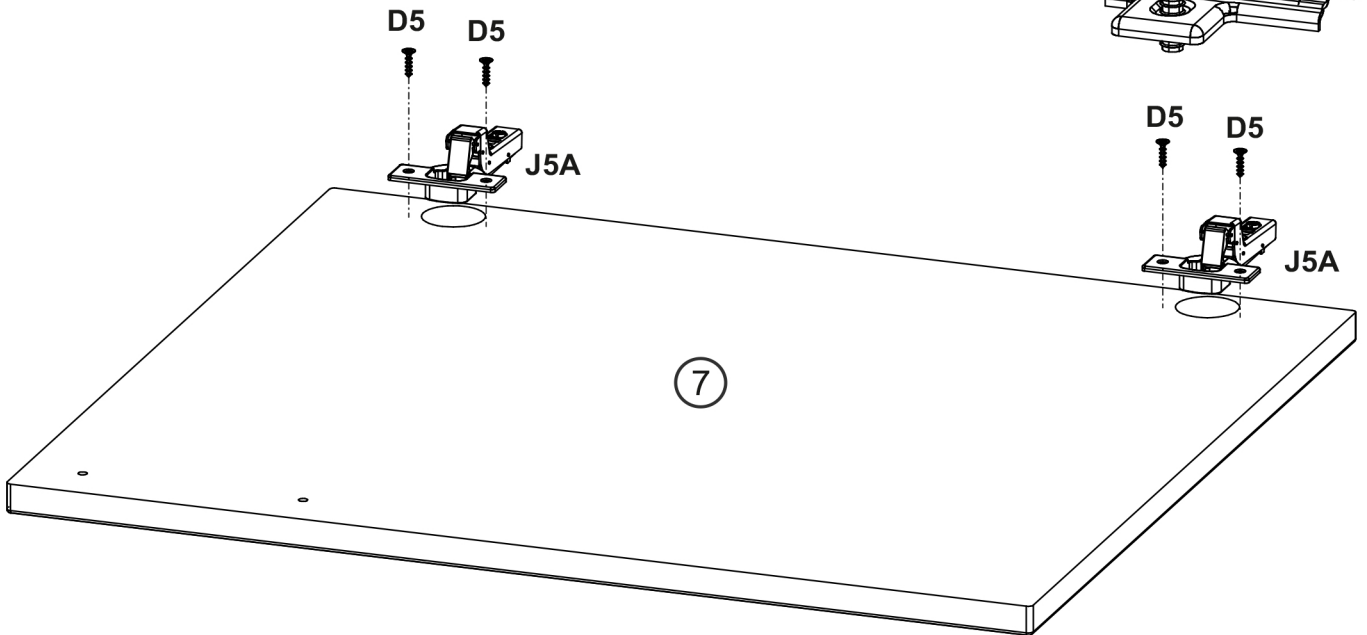
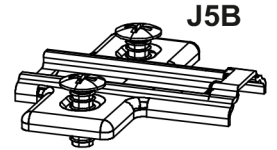
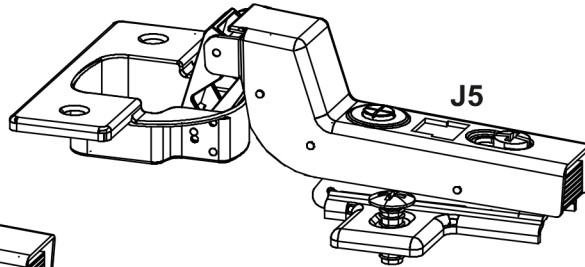
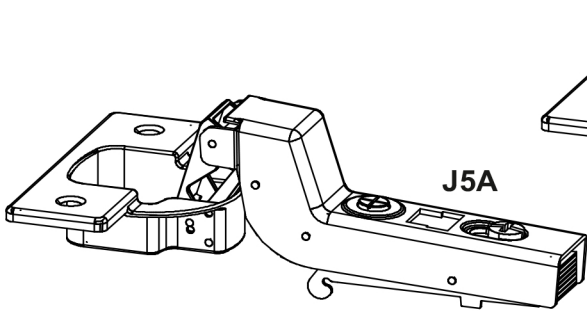
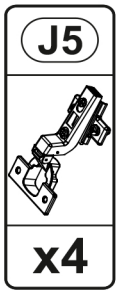
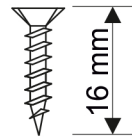

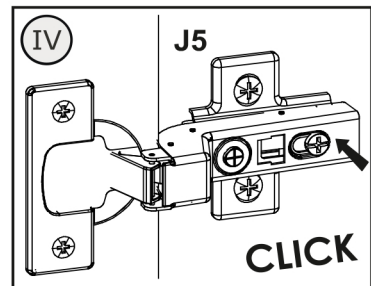
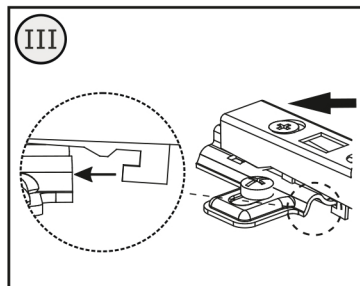
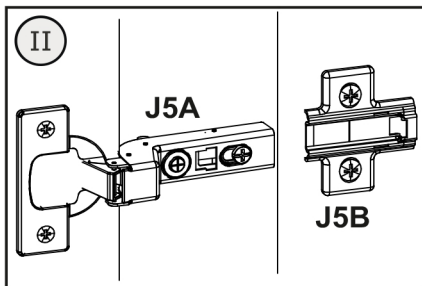
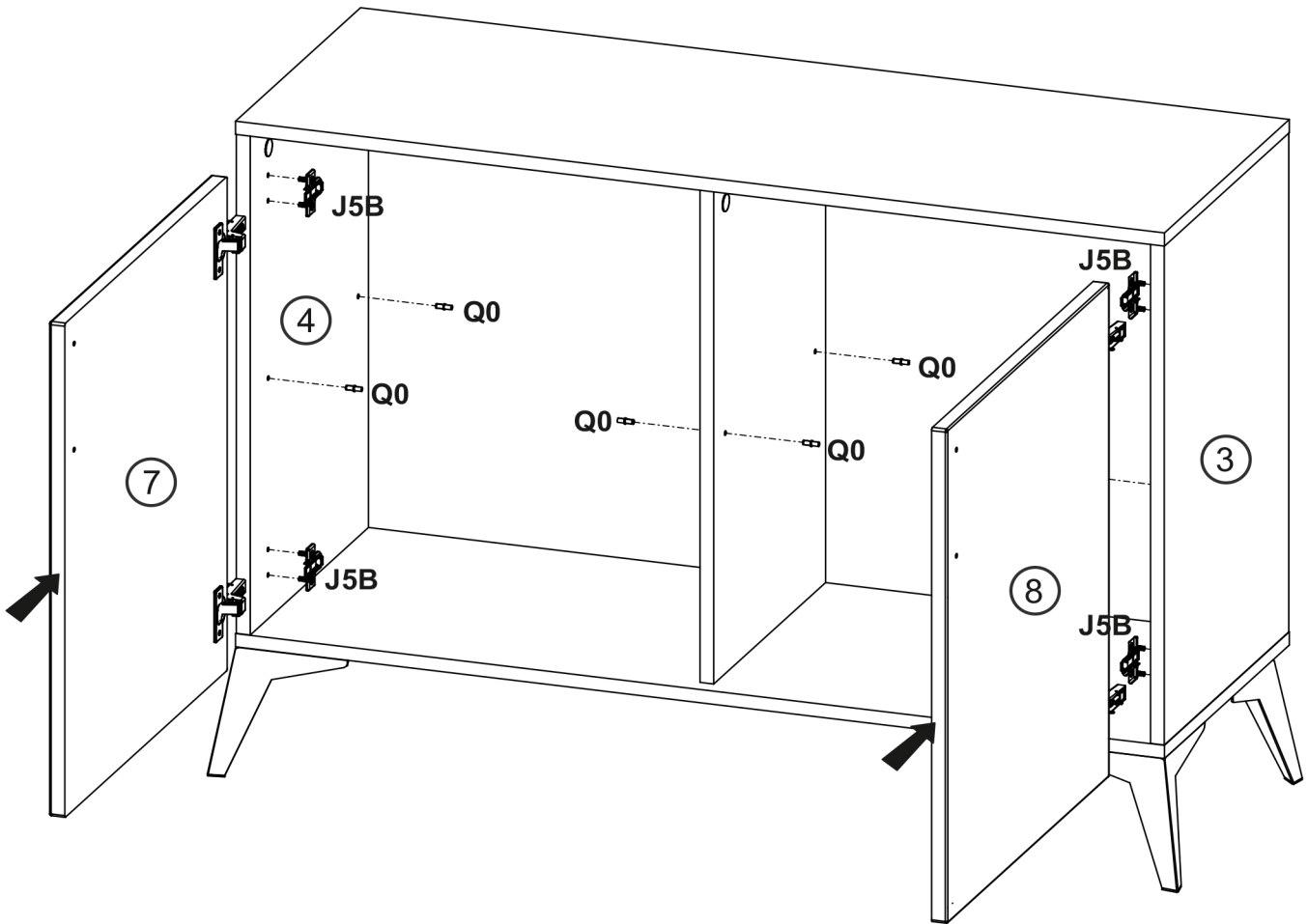
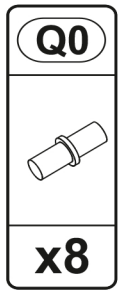
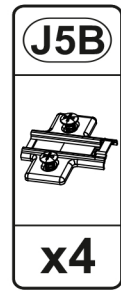
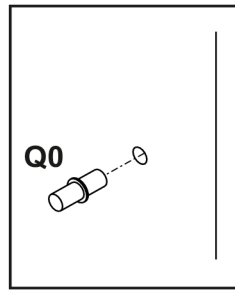
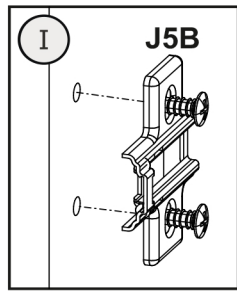

9

