

1124 401

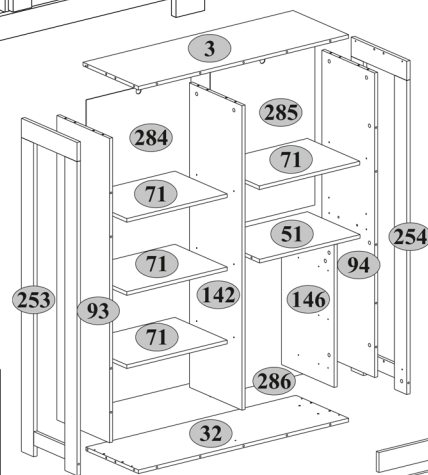

1462



A1	A2	B5	C1
7x34	42	Ø15x12	42
10x50	2	8x35	50
D1	E2	H48	I
2	2	4	S4
N1	M5	P5	Q
6	M4x25	8	16
1,5x7	5		
R3	R23	R24	R27
3x20	50	6,3x13	4
7x90	18	5,0x13	30
R33	R102	S1	S3
4x30	4	3,5x16	24
4	U.1	U5	V8
Ø18	24	45x35x15	2
36x36	4		
Z25			
300	3		

	mm	mm	mm	
3	1086	382	16	1
32	1086	362	16	1
51	519	362	16	1
71	519	360	16	2(2)
93	1332	362	16	1
94	1332	362	16	1
139	1124	84	18	1
140	955	60	16	1
142	1332	362	16	1
146	625	362	16	1
156	474	210	19	3
176	320	100	16	3
177	320	100	16	3
186	402	100	16	3
226	1258	474	19	1
253	1458	382	18	1
254	1458	382	18	1
284	1352	541	2,5	1
285	706	541	2,5	1
286	646	541	2,5	1
311	432	325	2,5	3
541	1374	84	18	1
542	1374	84	18	1

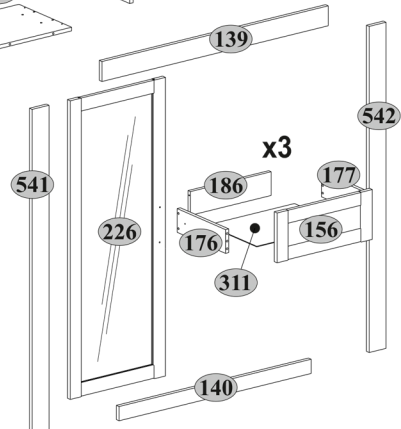
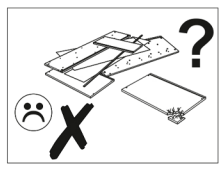

1

A1



7x34

A2



6

Ø15x12

C1

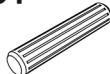

16

8x35

12

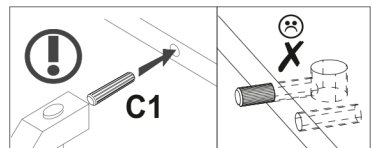
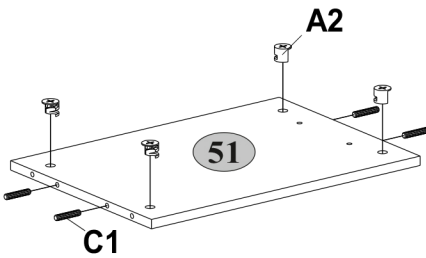
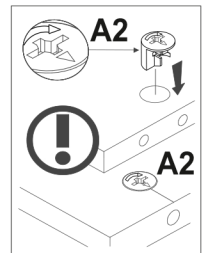
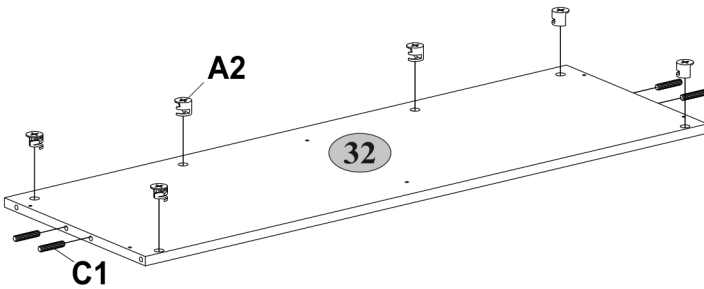
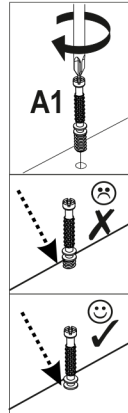
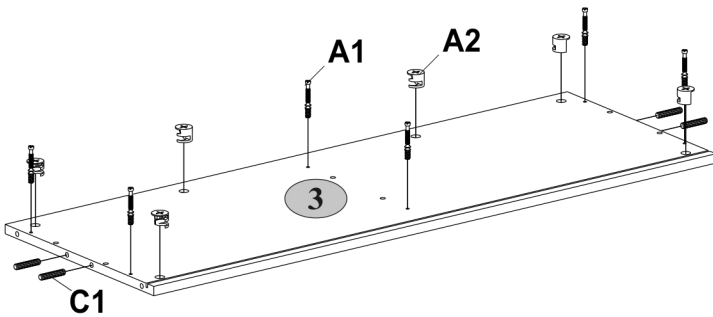

2**A1**

7x34

A2

2

Ø15x12

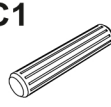
C1

10

8x35

P5

8

8

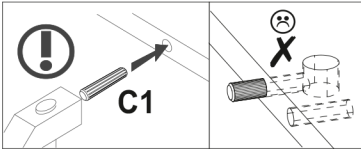
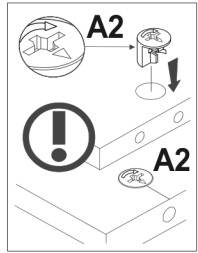
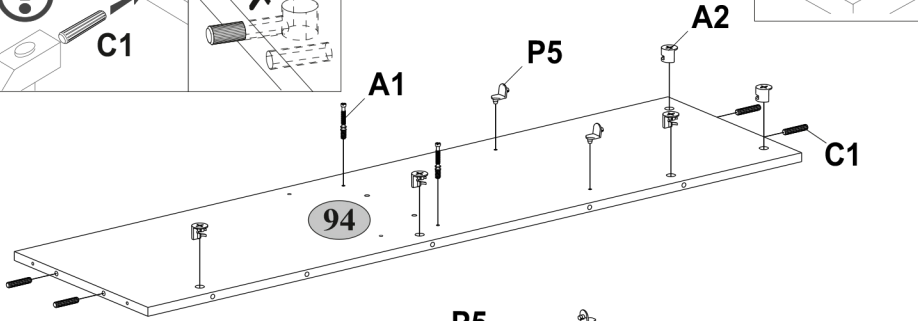
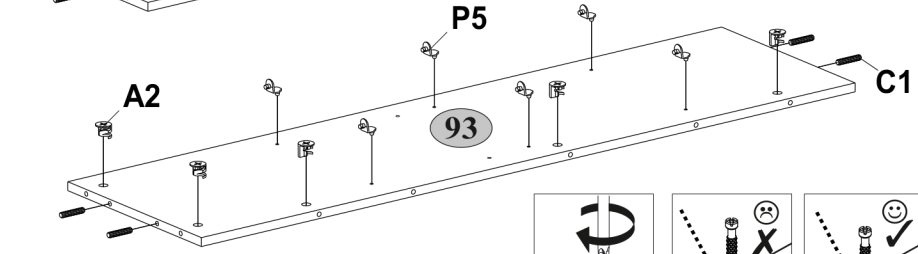
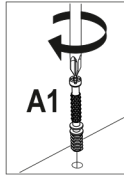
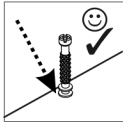
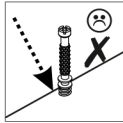
**C1****94****93****A1****3****A1**

7x34

A2

8

Ø15x12

2

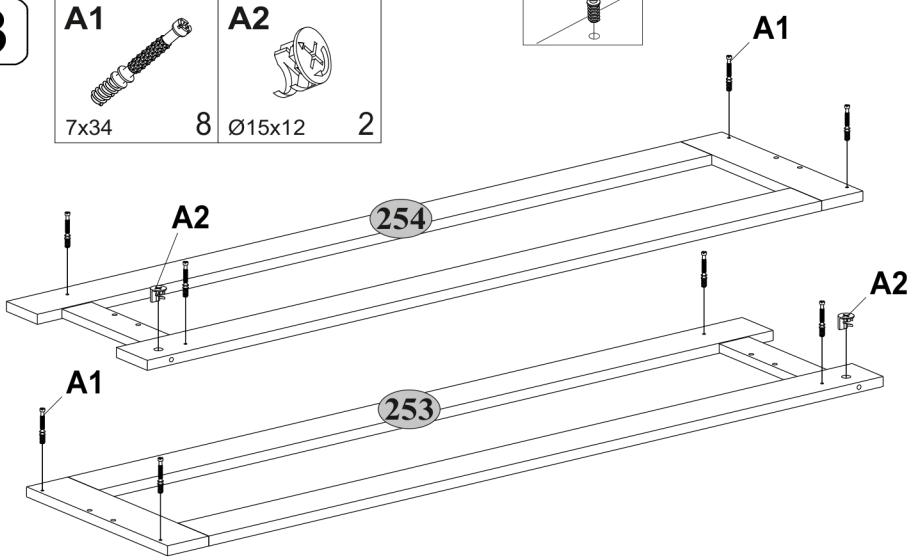
**254****253**

4**A1**

7x34

2

A2

Ø15x12

2

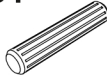
C1

8x35

8

P5

8

R27

5,0x13

18

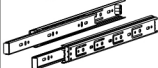

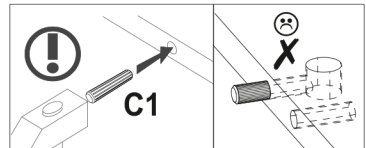
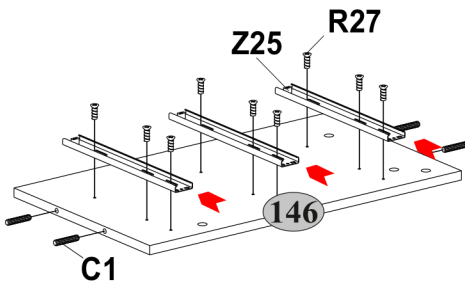
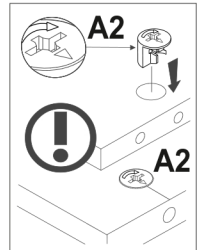
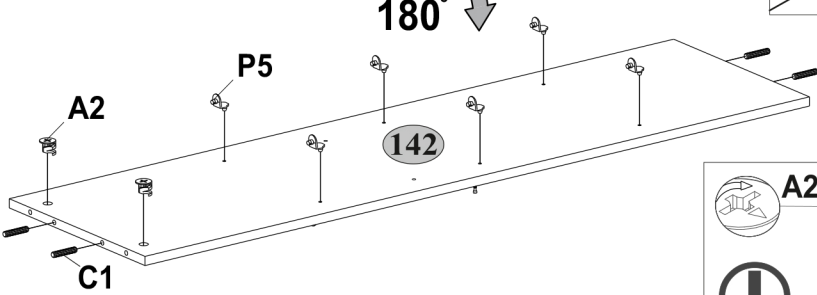
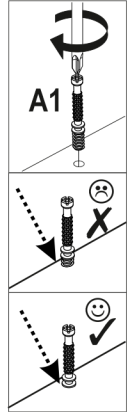
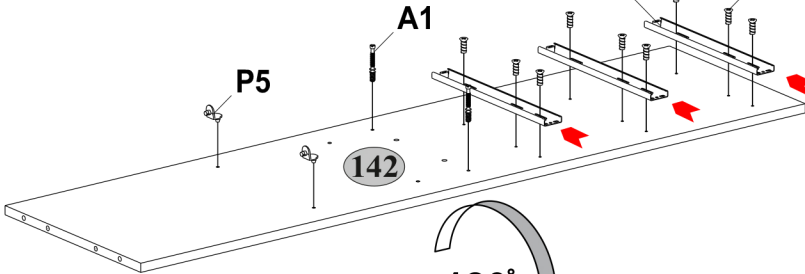
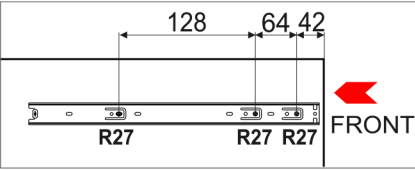
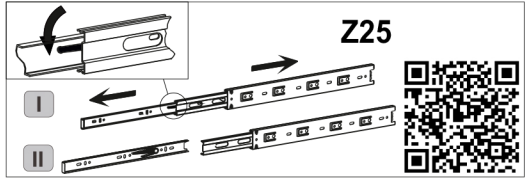

Z25

300

3

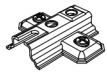

5

A1  7x34	D1  2	R23  6,3x13	R102  3,5x16	U5  36x36
12		4	16	4

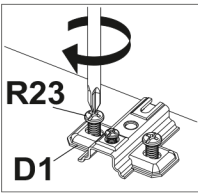
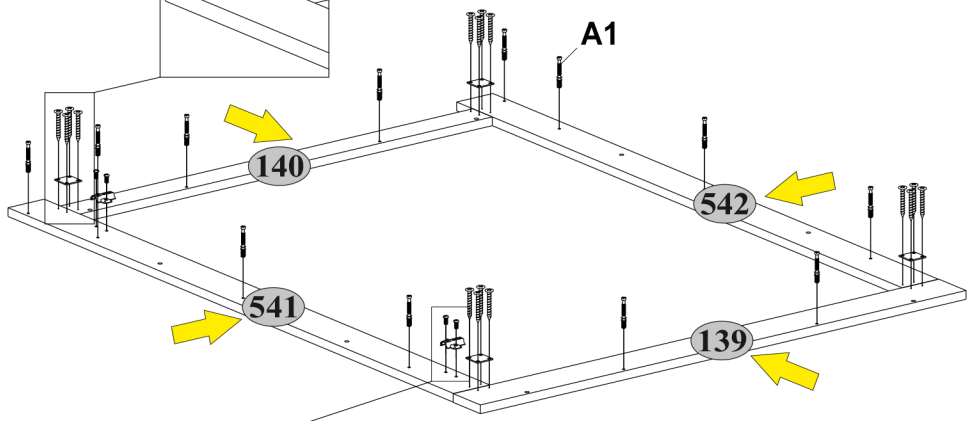
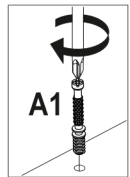
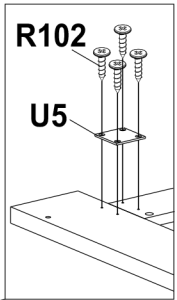

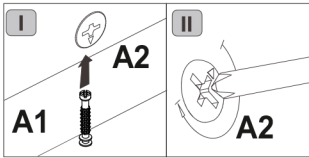
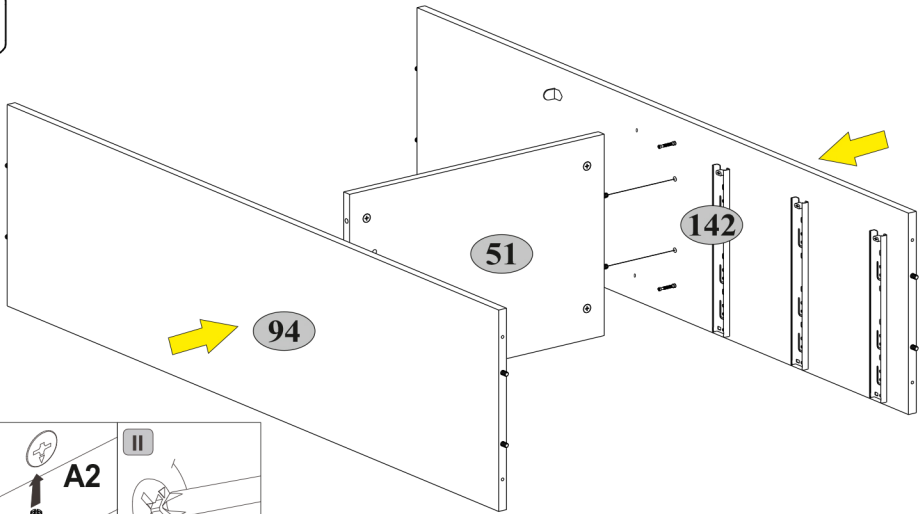

6

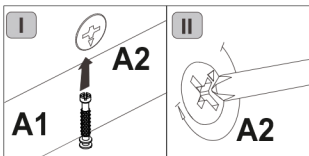
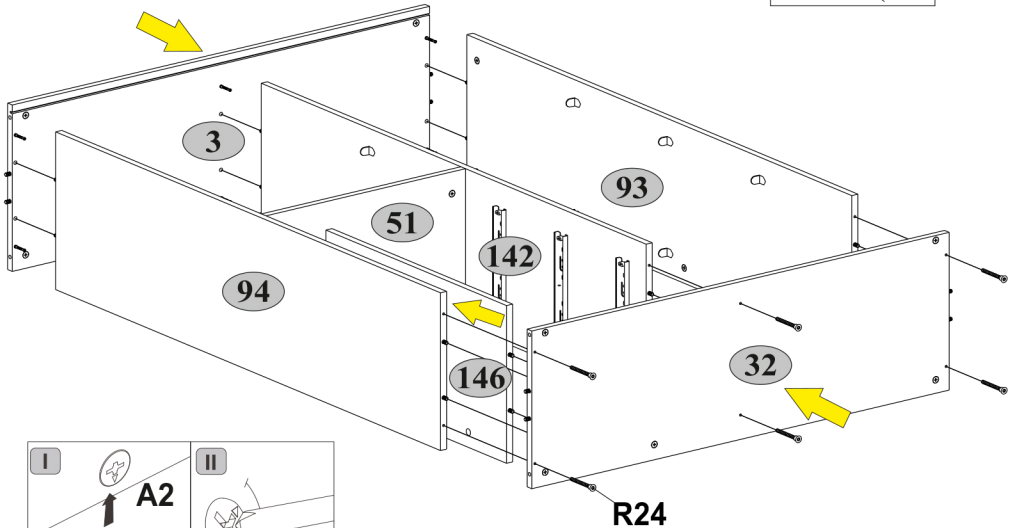
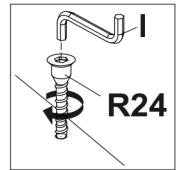
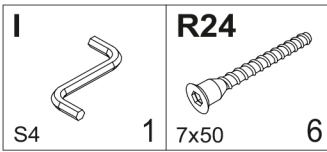

7



8

R3  3x20 26	S1  4	S3  6
---	--	--

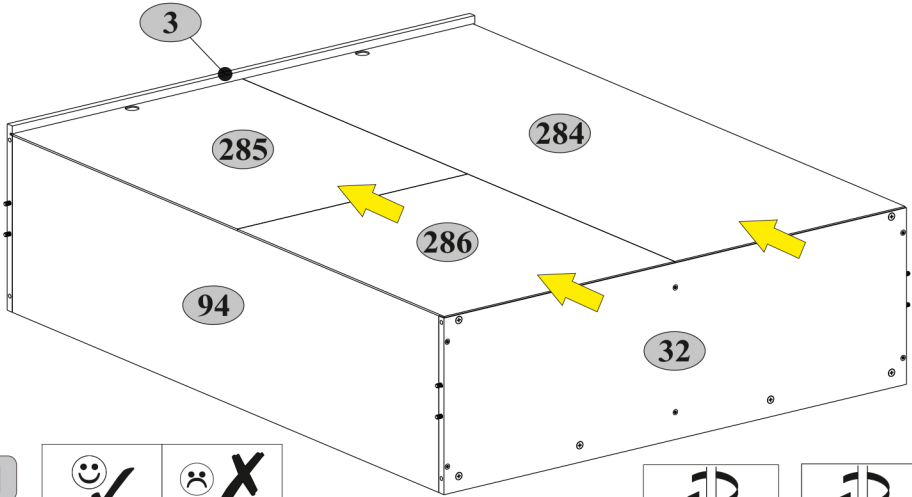
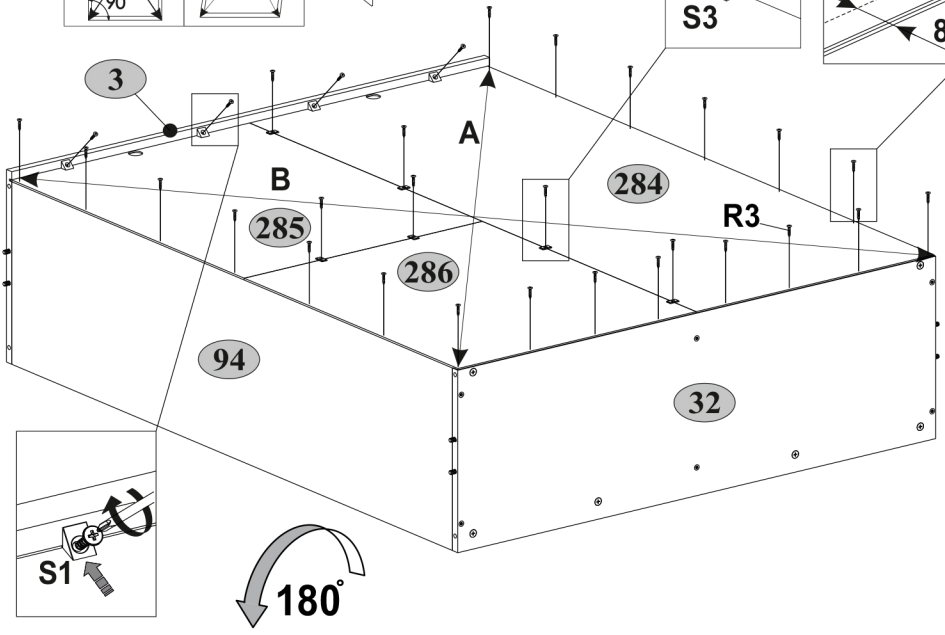
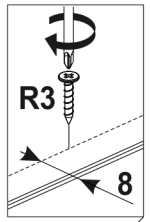
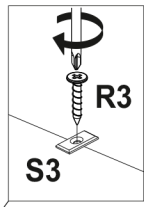
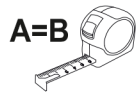
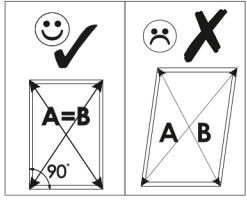
I**II**



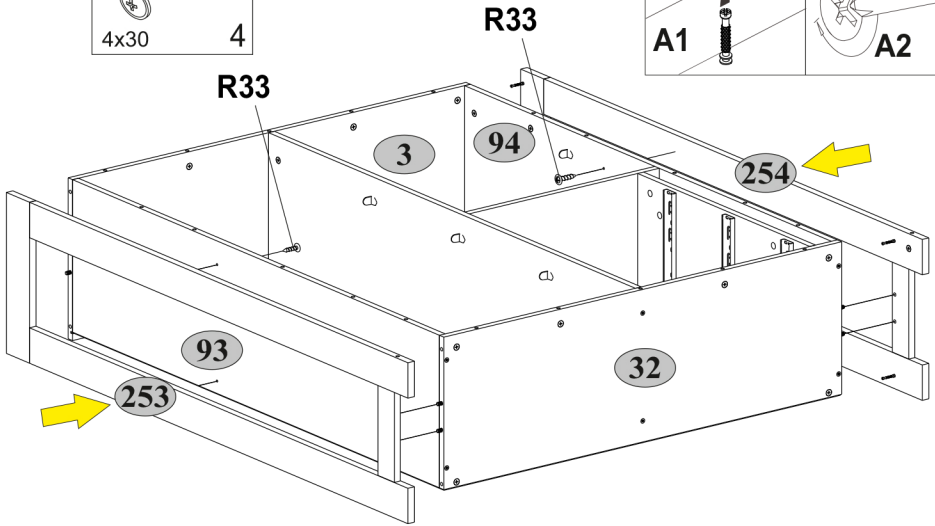
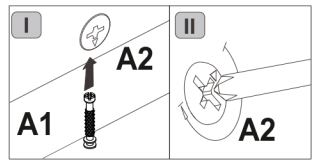
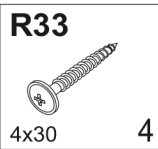

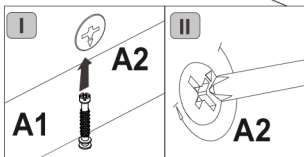
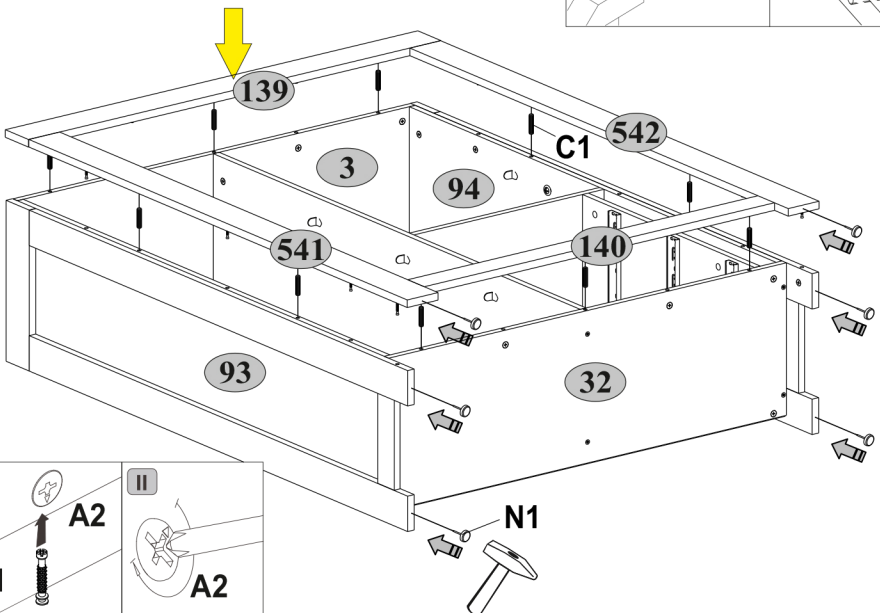
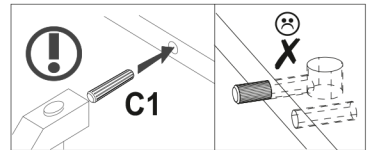
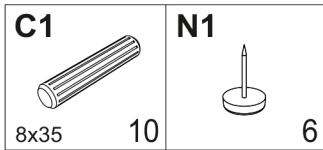

9



10

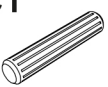
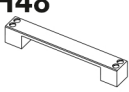

11**x3**

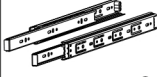
A1  7x34 12	A2  Ø15x12 12	C1  8x35 12	H48  3	I  S4 1
M5  M4x25 6	R24  7x50 12	R27  5,0x13 12	Z25  300 3	

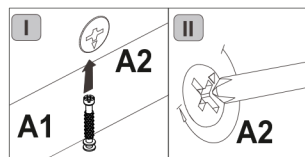
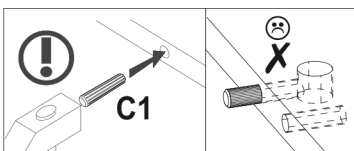
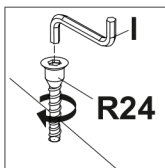
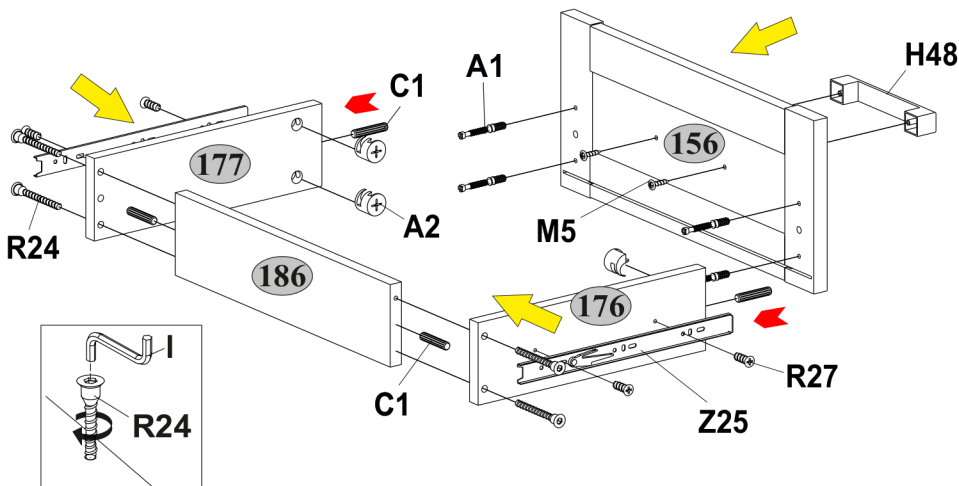
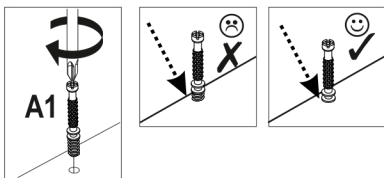
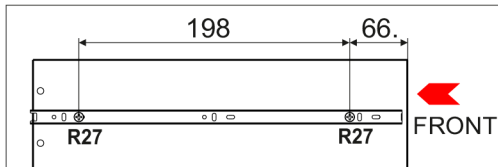
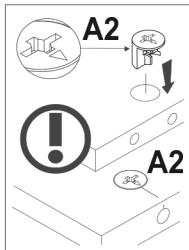

12**x3****R3**

3x20

24

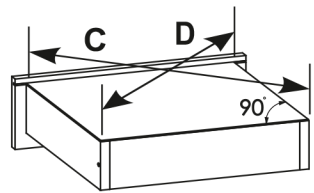
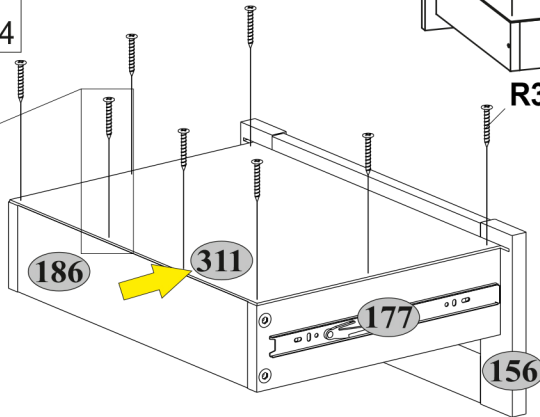
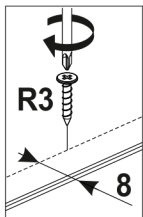
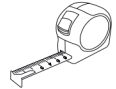
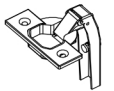
**R3****C=D****13****E2**

2



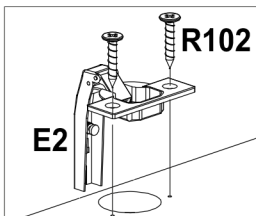
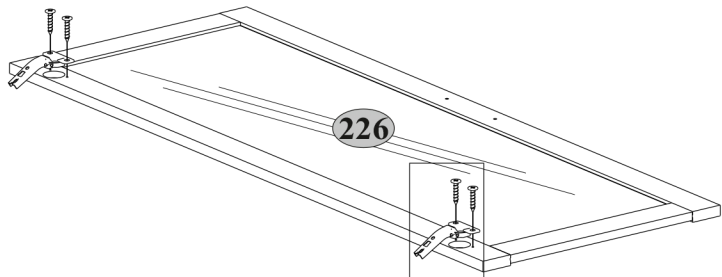

R102

3,5x16

4



14

B5  10x50 2	Q  1,5x7 5	R102  3,5x16 4	S5  Ø18 24	U.1  45x35x15 2
---	--	---	--	---

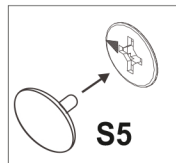
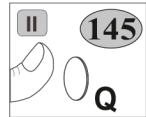
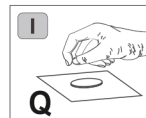
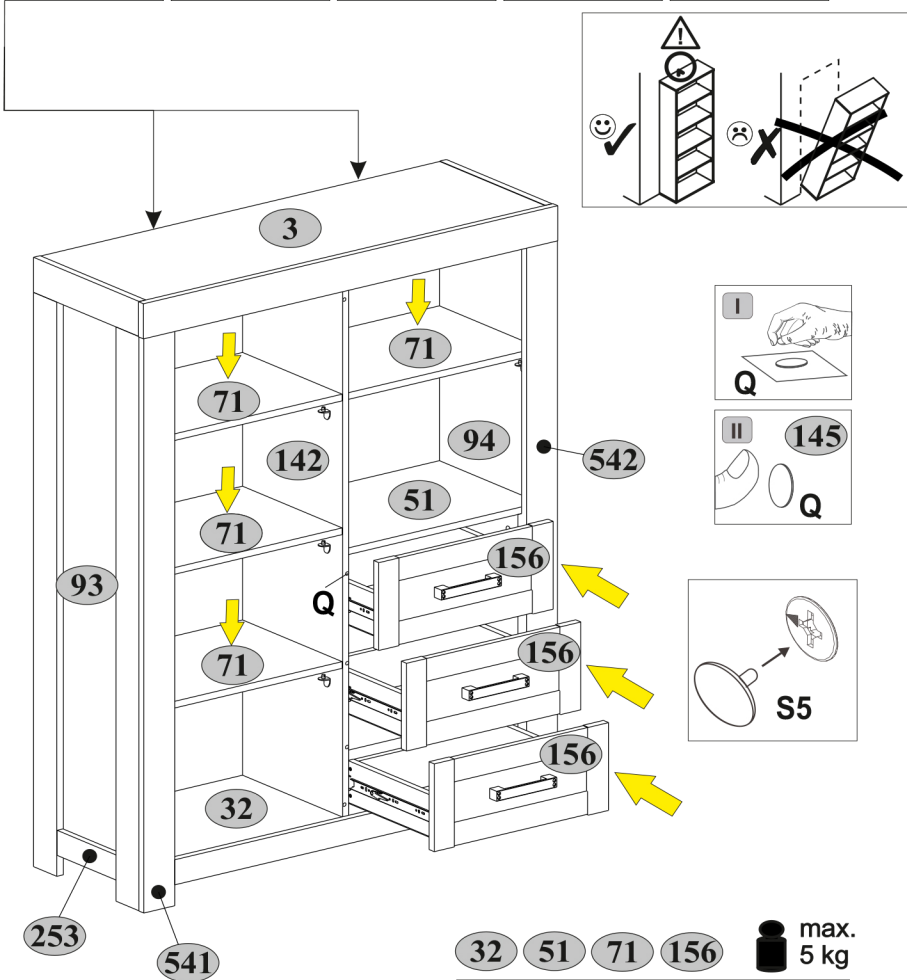
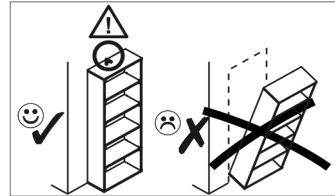
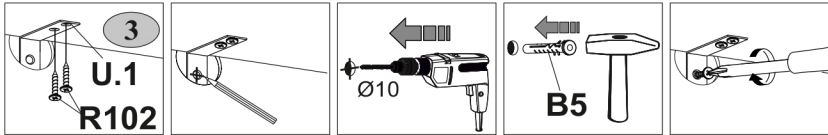

32 **51** **71** **156**

 max.
5 kg

3  max.
15 kg

15

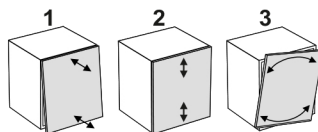
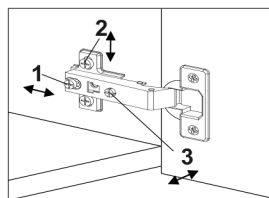
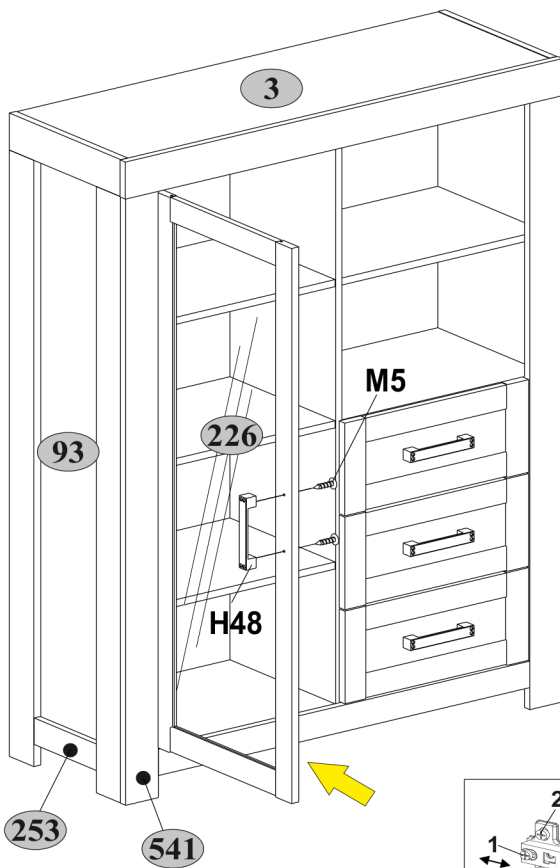
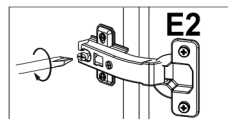
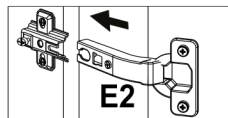
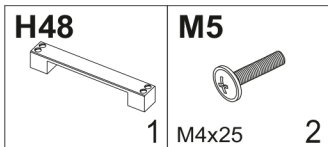

16**V8**