

MOBI 13

Art.-Nr.

355 479
355 482

	580
	1070
	180
	mm

1/6
VO

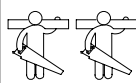

60 min

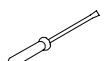

PZ2; PZ1



0,5 kg



3m

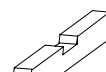

600 mm



Ø8



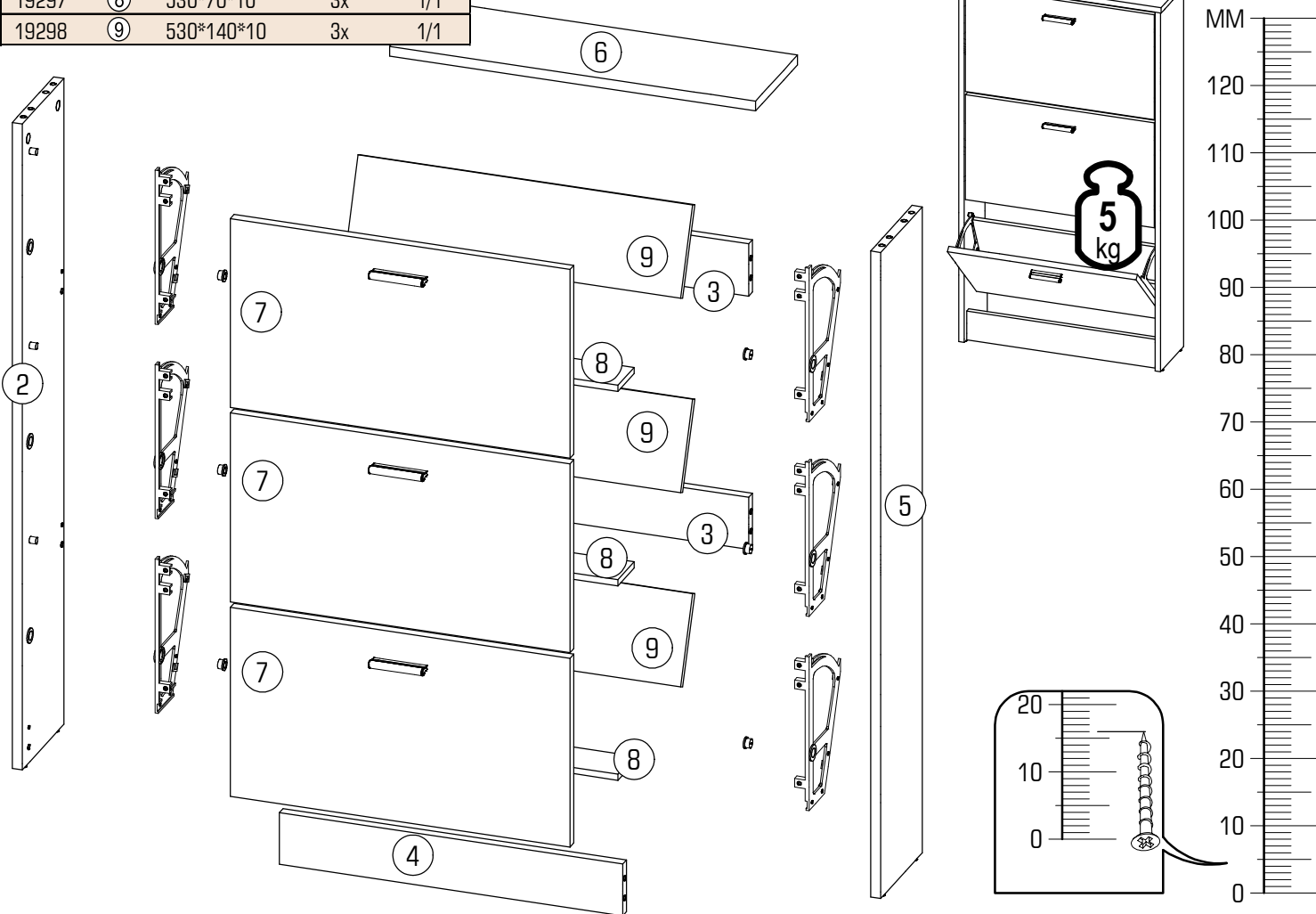
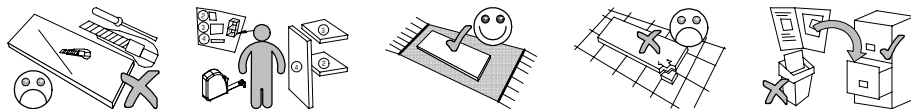

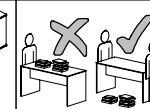
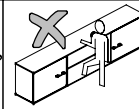
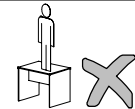
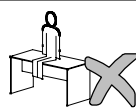
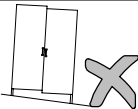

ID	ID	Image	Image	Image
19291	②	1050*178*16	1x	1/1
19292	③	544*85*16	2x	1/1
19293	④	544*84*16	1x	1/1
19294	⑤	1050*178*16	1x	1/1
19295	⑥	580*180*16	1x	1/1
19296	⑦	538*307*16	3x	1/1
19297	⑧	530*70*10	3x	1/1
19298	⑨	530*140*10	3x	1/1

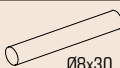

22244.01		Ø3,5x16	22236.00		Ø2,5x16	27000.00		Ø8x30	30091.00		70013.01		Ø15x13	70021.01		22255.00		Ø5,0x50	22430.00		Ø4x25	22708.00		Ø6,0x16
A	2x	B	24x	C	10x	D	4x	E	10x	F	10x	G	1x	H	6x	I	6x	J	24x					
	4x	24101.00		Ø10	31103.00		24113.00		6x	24114.00		6x	24115.00		6x	32314.01		L=85	31131.00		3x	31130.00		3x
K	4x	L	1x	M	1x	N	6x	P	6x	Q	6x	R	3x	S	3x	T	3x							

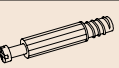

2/6 MOBI 13

							
A 2x	C 10x	D 4x	E 10x	F 10x	M 1x	P 6x	Q 6x

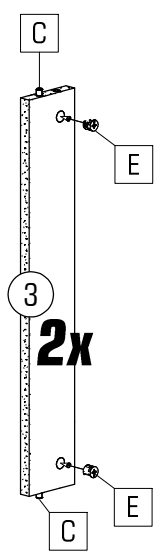
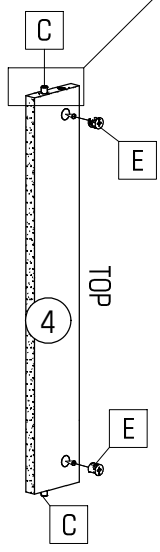
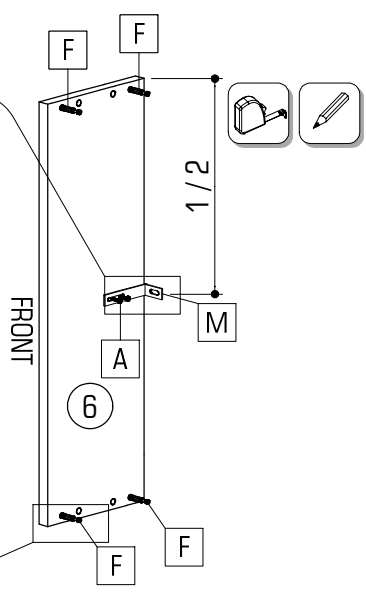
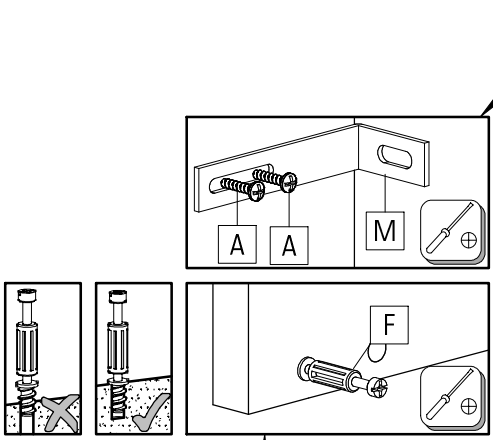
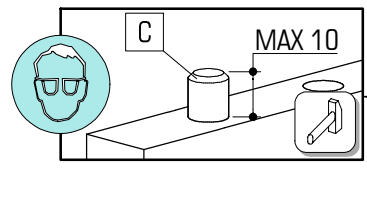
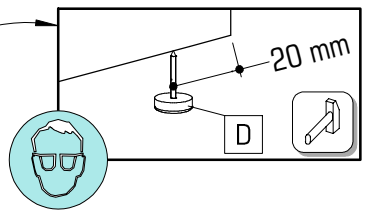
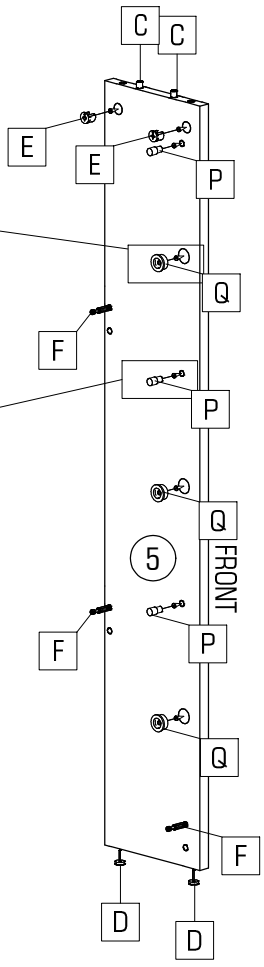
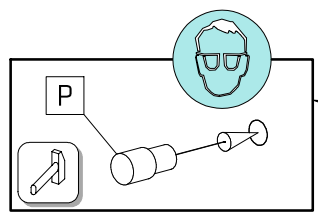
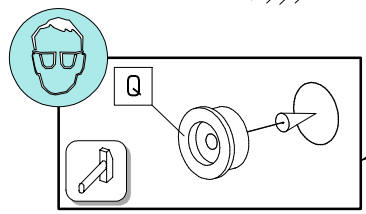
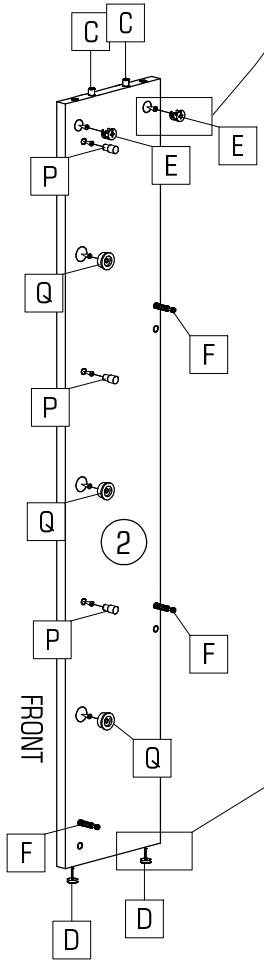
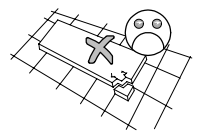
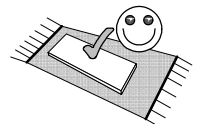
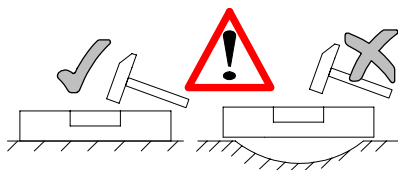
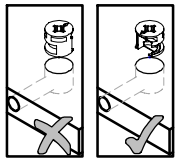
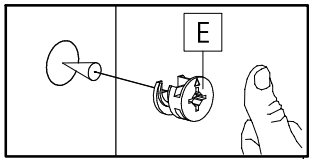

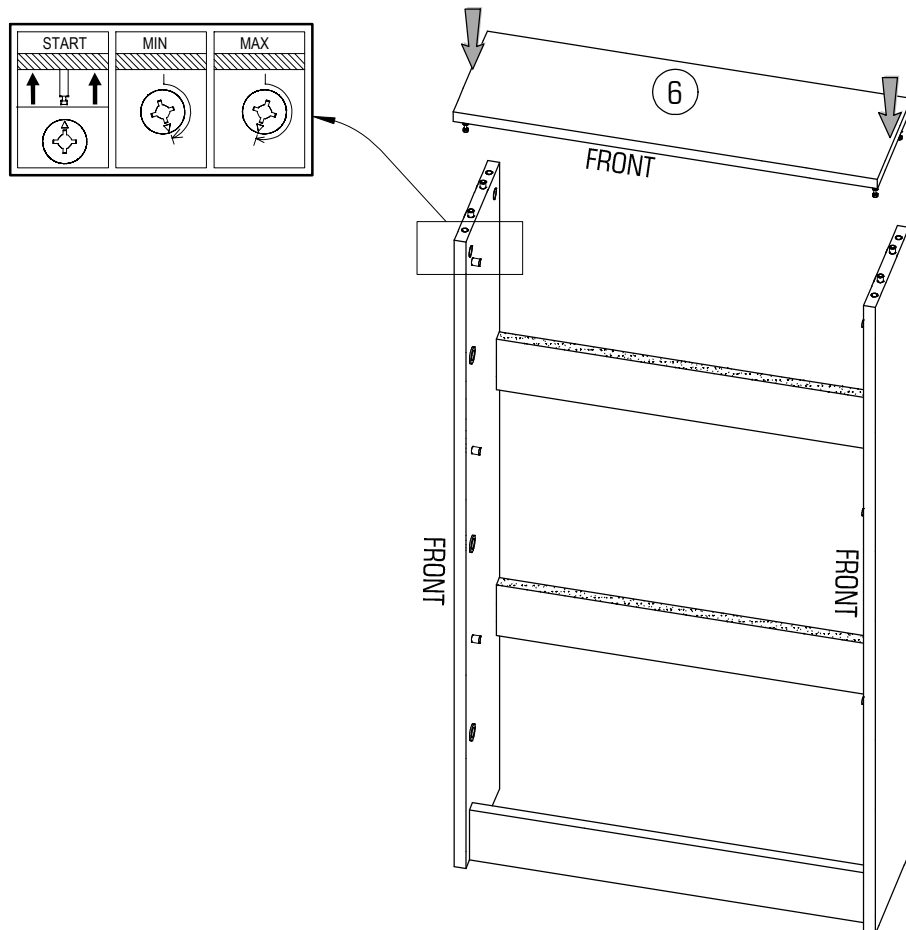
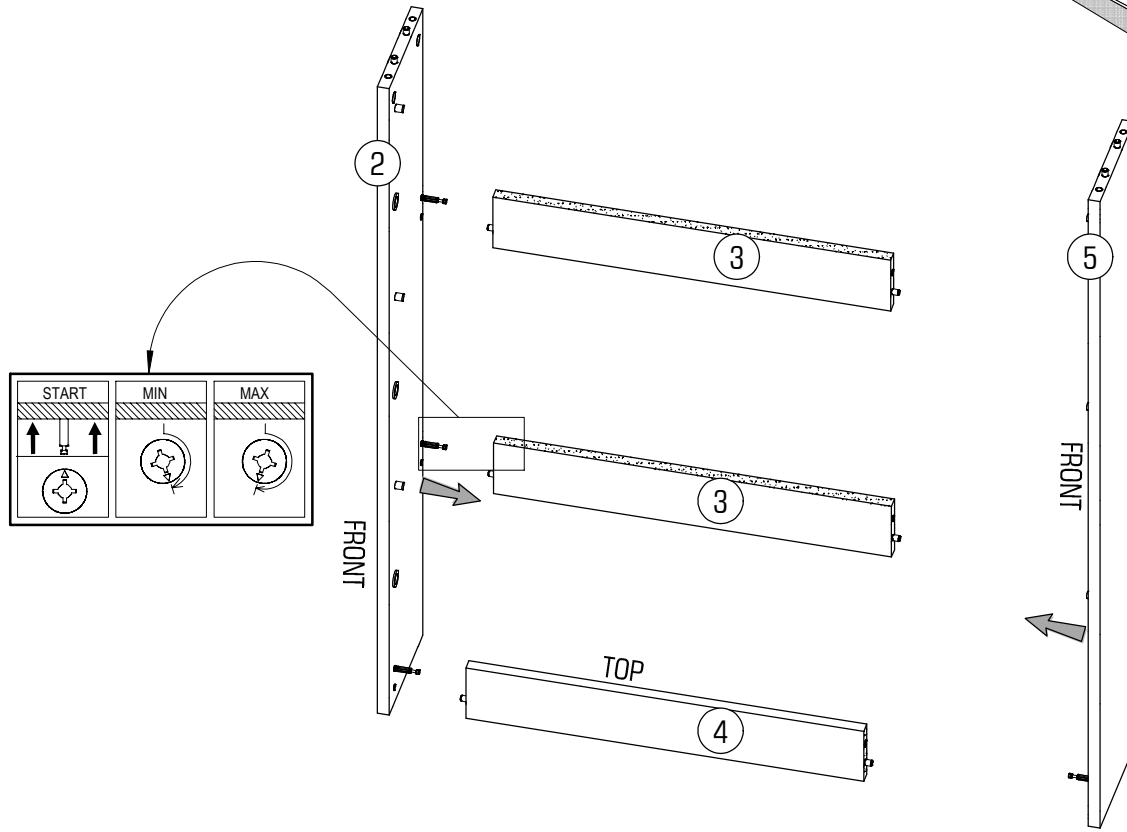
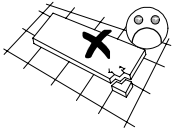

4/6 MOBI 13

Ø5,0x50		Ø10
G 1x	K 4x	L 1x

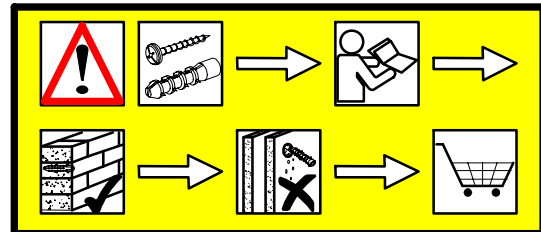
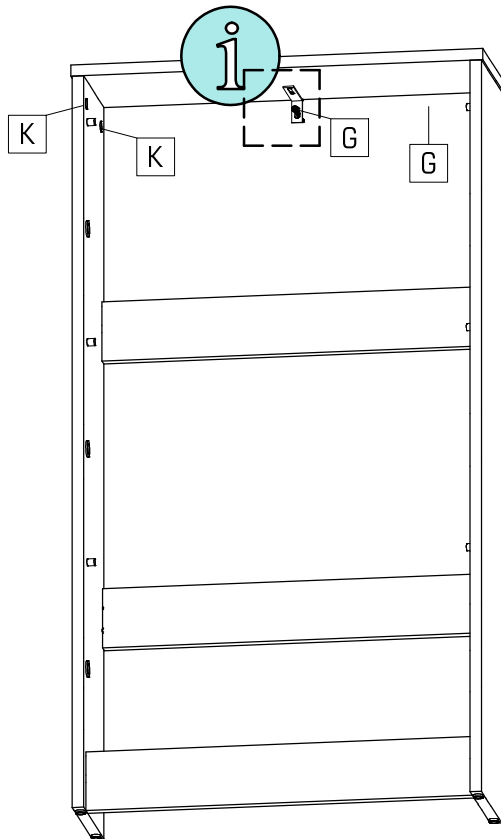
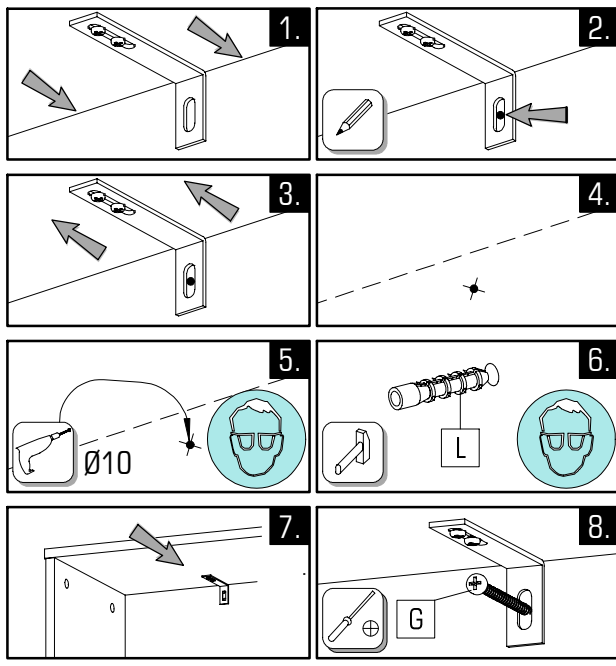
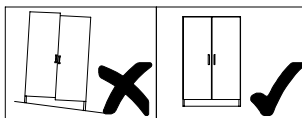

Caution! The wall must be examined before assembly. The included universal wall plugs are only suitable for using in firm masonry such as concrete block or brick. Do not use the wall plugs masonry such as hollow brick, lightweight block, surfaces such as gypsum plasterboard or other framing systems. If applicable, particular wall plugs must be used! These are available at a specialised store (hardware store). In case of non-compliance, the manufacturer/retailer or importer do not assume liability.

Upozornenie! Pevnosť steny sa musí pred montážou bezpodmienečne skontrolovať. Priložené univerzálne hmoždenky používajte jedine pre pevné murivo ako je betón/tehta. Hmoždenky sa nesmú používať v prípade ľahkého stavebného muriva, dutá tehta, Sádrokartónová doska, alebo iných konštrukcií rámu. U týchto stien je nutné použiť špeciálne hmoždenky! Tieto je možné dostať v špeciálnych predajniach so stavebným materiálom. Pri nedodržiati pokynov nepreberajú výrobcovia/predajci a dodávateľa zodpovednosť za vzniknuté škody.

Upozornění! Před montáží je nutné zkontrolovat stav stěny. Přiložené univerzální hmoždinky jsou určeny pouze k použití pro pevné zdivo jako beton/cihly. Hmoždinky do zdi se nesmí používat u dutinová cihla, zdiva jako pórovitý stavební kámen, sádrokartónová deska nebo jiný měkký materiál. U těchto zdív jsou nutné použít speciální hmoždinky! Jsou k dostání v speciálních prodejnách se stavebním materiálem. Při nedodržení těchto pokynů výrobce/prodejce a dovozce neručí za způsobené škody.

Pažnja! Prije montaže obavezno provjerite svojstvo zida. Priložene univerzalne tiple namijenjene su isključivo za masivne zidove od betona/opeke. Tiple za masivne zidove ne smiju se koristiti za zidove kao npr šupljina opeka laki sastavni elementi, gips-kartonske ploče ili drugi modularni načini gradnje. Za te zidove potrebne su eventualno specijalne tiple! Iste su dostupne u specijaliziranim trgovinama građevinskim materijalom. U slučaju nepridržavanja prethodno navedenih napomena, proizvođač/trgovac i uvoznik ne preuzimaju odgovornost!

Achtung! Die Wandbeschaffenheit ist vor der Montage unbedingt zu prüfen. Die beigelegten Universaldübel sind ausschließlich nur zur Verwendung für festes Mauerwerk wie Beton/Ziegel. Die Mauerdübel dürfen nicht bei Mauerwerk wie Hohlraumziegel, Leichtbausteinen, Gipskartonplatte oder anderer Rahmenbauweise verwendet werden. Bei diesen Mauerwerken sind gegebenenfalls Spezialdübel zu verwenden! Diese sind in einem Fachgeschäft erhältlich. Bei Nichteinhaltung wird seitens Produzenten/Händler und Importeur keine Haftung übernommen.

Vigyázat! Szerelés előtt a falfelületet feltétlenül vizsgálja meg. A mellékelt univerzális tiplik kizárólag stabil falazathoz használható mint például beton/tégla. A fali tipli nem használható könnyű építőkövekhez, üreg tégla, gipszkarton lapokhoz vagy más fázvas építményekhez. Ezekhez a falfelületekhez csak speciális tiplik használhatóak, melyek szaküzletekben (barkácsáruházakban) beszerezhetőek. Fentiek figyelmen kívül hagyása esetén a gyártó/kereskedő vagy forgalmazó nem vállal felelősséget.



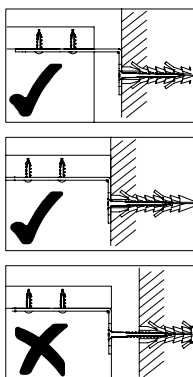

Uwaga! Ścianę należy sprawdzić przed montażem. Dołączone uniwersalne kołki rozporowe są odpowiednie tylko do stosowania w mocnych murach, takich jak beton lub cegła. Nie rób za pomocą kołków rozporowych murowanych, takich jak pustak, lekka kostka, powierzchnie takie jak płyty gipsowo-kartonowe lub inne systemy ram. Jeśli dotyczy, muszą to być określone kołki rozporowe być użytym! Są one dostępne w specjalistycznym sklepie niezgodność, producent / sprzedawca lub importer nie ponoszą odpowiedzialności.

Prudență! Zidul trebuie examinat înainte de asamblare prizele de perete sunt adecvatenumai pentru utilizarea în zidărie fermă, cum ar fi betonul bloc sau cărămidă. Nu folosiți zidăria zidurilor de perete, cum ar fi cărămida goală, blocul ușor, suprafețe cum ar fi gips-carton sau altă încadrare sisteme. Dacă este cazul, trebuie folosite anumite prize de perete! Acestea sunt disponibile la un magazin specializat (magazin de hardware) . În caz de nerespectare, producătorul / vânzătorul cu amănuntul sau importatorul nu își asumă răspunderea.

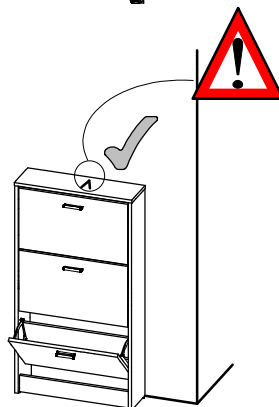

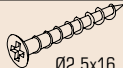
- EN WARNING
- SK VÝSTRAHA
- CZ VAROVÁNÍ
- HR UPOZORENIE
- DE WARNUNG
- HU FIGYELEM
- SE VARNING
- SI OPOZORILO
- PL OSTRZEŻENIE

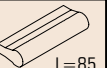

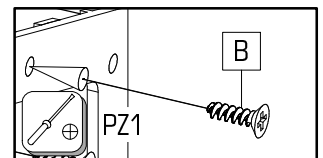
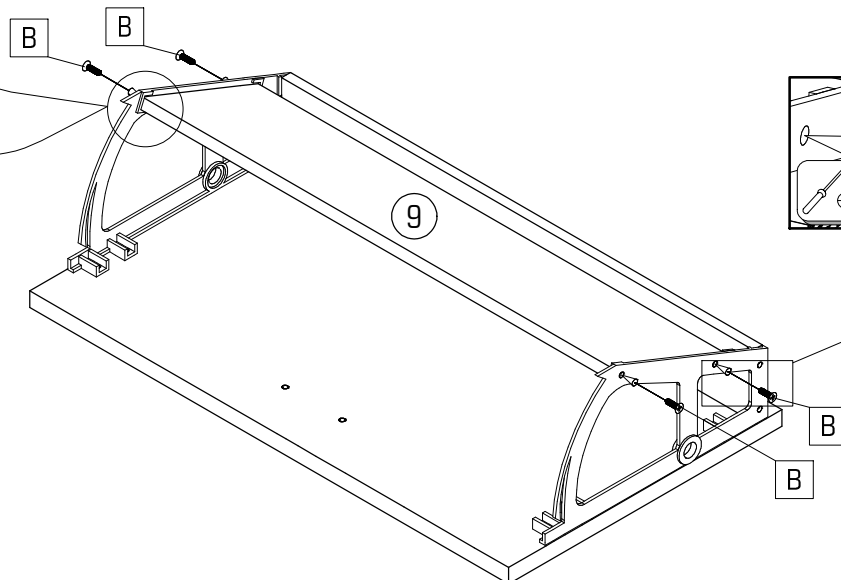
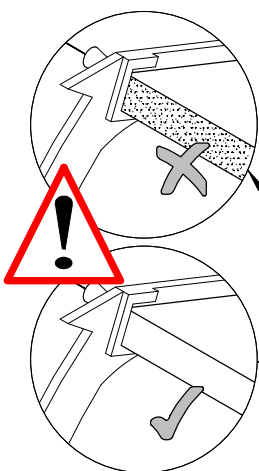
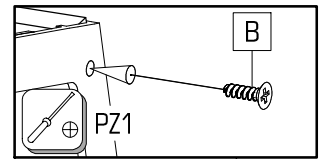
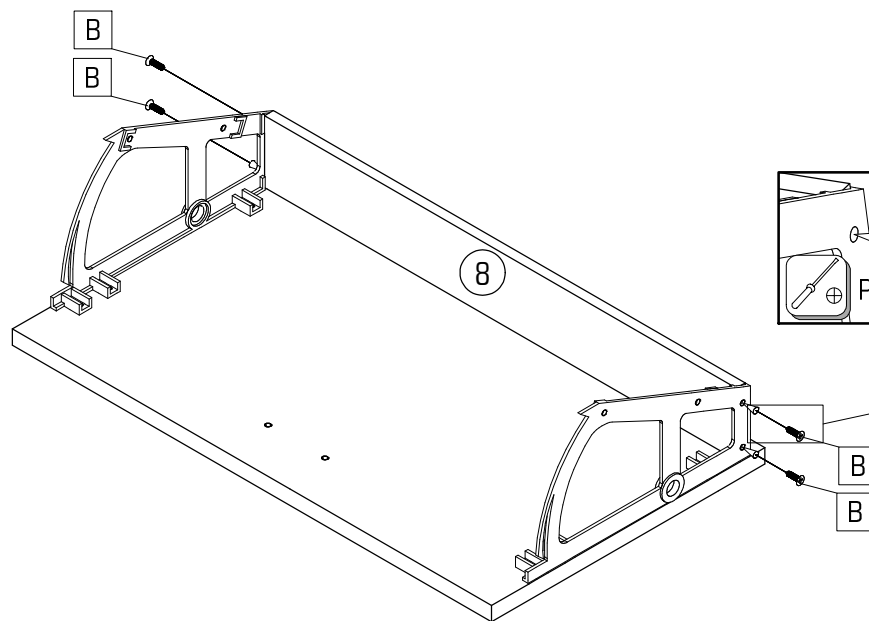
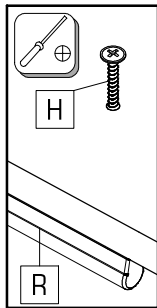
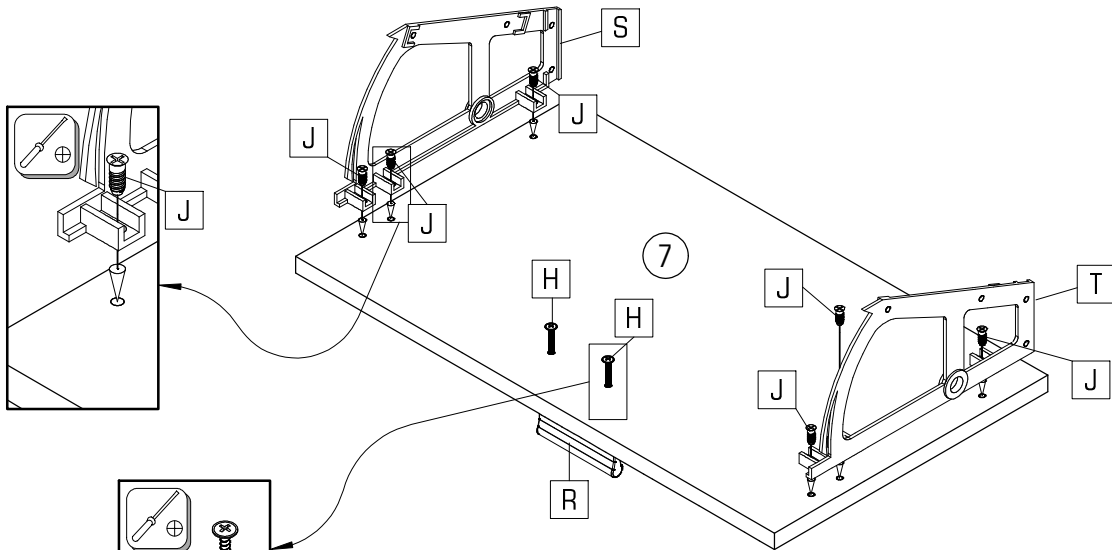
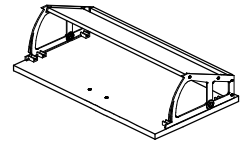

					
B	H	J	R	S	T
24x	6x	18x	L=85	3x	3x

3x



6/6 MOBI 13

	$\varnothing 6,0 \times 16$		
J	6x	N	4x

