

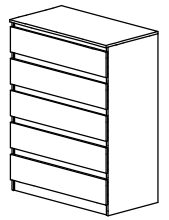

HANY NEW ABS 05

| | | | |
|----------|---------|--------|-----|
| Art.-Nr. | 281 048 | ↔ 900 | 1/4 |
| | 281 050 | ↗ 1173 | |
| | 281 051 | ↘ 490 | |
| | | mm | v0 |







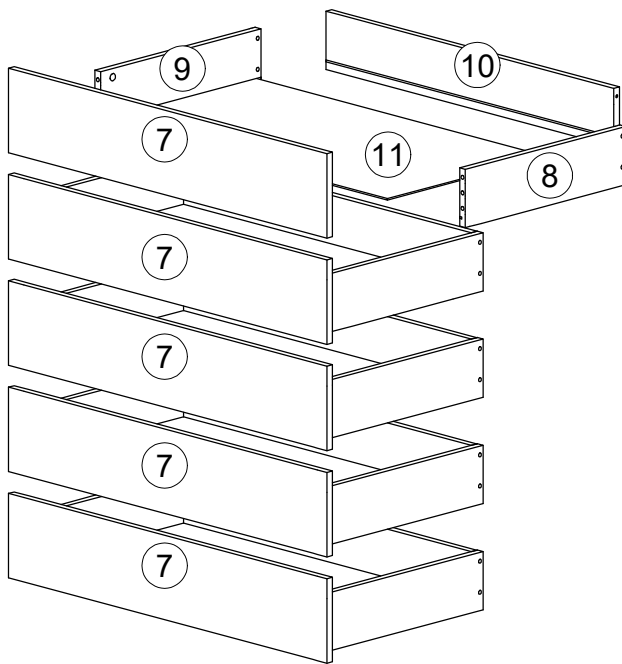
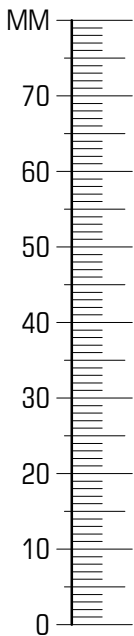
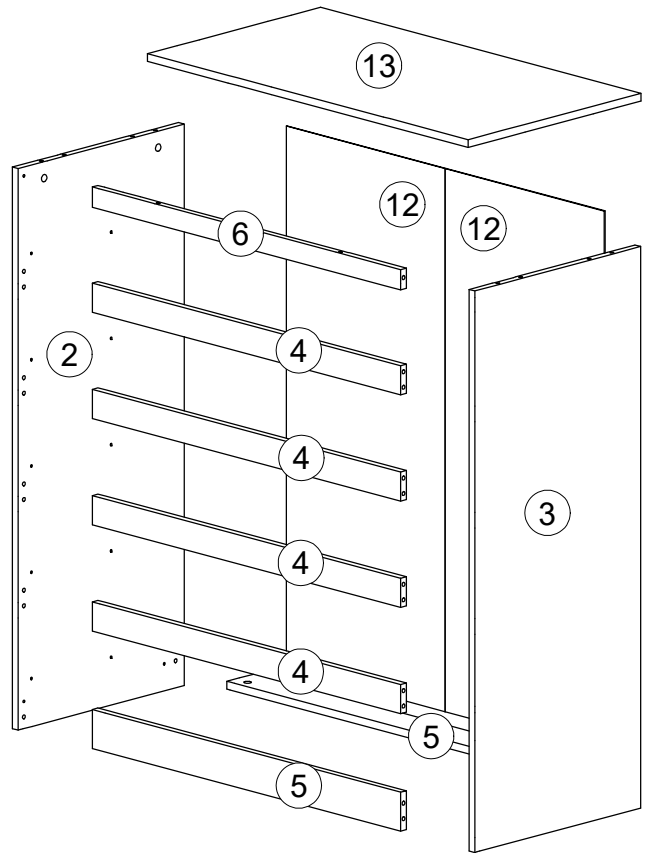
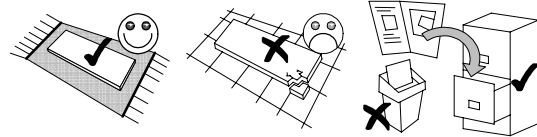

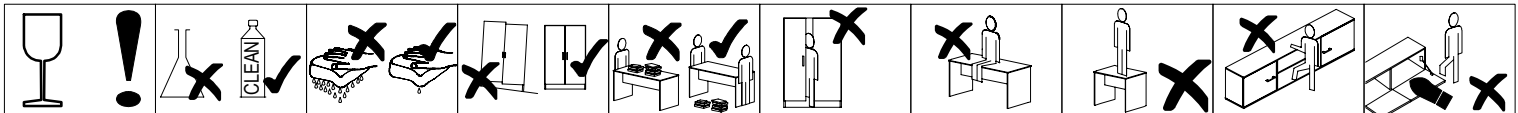

| | | | | | | | | |
|-------|--|--|--|---|-----|----------|----|--------|
| 60min | | | | 4 | PZZ | ≤ 0,5 kg | 3m | 600 mm |
|-------|--|--|--|---|-----|----------|----|--------|

| ID | Part No. | Dimensions | Qty | Ratio |
|-------|----------|--------------|-----|-------|
| 06321 | ② | 1157*466*16 | 1x | 1/2 |
| 06322 | ③ | 1157*466*16 | 1x | 1/2 |
| 01253 | ④ | 866*60*16 | 4x | 1/2 |
| 01254 | ⑤ | 866*80*16 | 2x | 2/2 |
| 01255 | ⑥ | 866*42*16 | 1x | 2/2 |
| 15353 | ⑦ | 894*174*16 | 5x | 2/2 |
| 01257 | ⑧ | 450*120*16 | 5x | 1/2 |
| 01258 | ⑨ | 450*120*16 | 5x | 1/2 |
| 01259 | ⑩ | 808*120*16 | 5x | 1/2 |
| 01260 | ⑪ | 818*446*2,5 | 5x | 1/2 |
| 06323 | ⑫ | 1119*446*2,5 | 2x | 1/2 |
| 15351 | ⑬ | 900*486*16 | 1x | 2/2 |

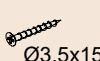

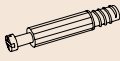



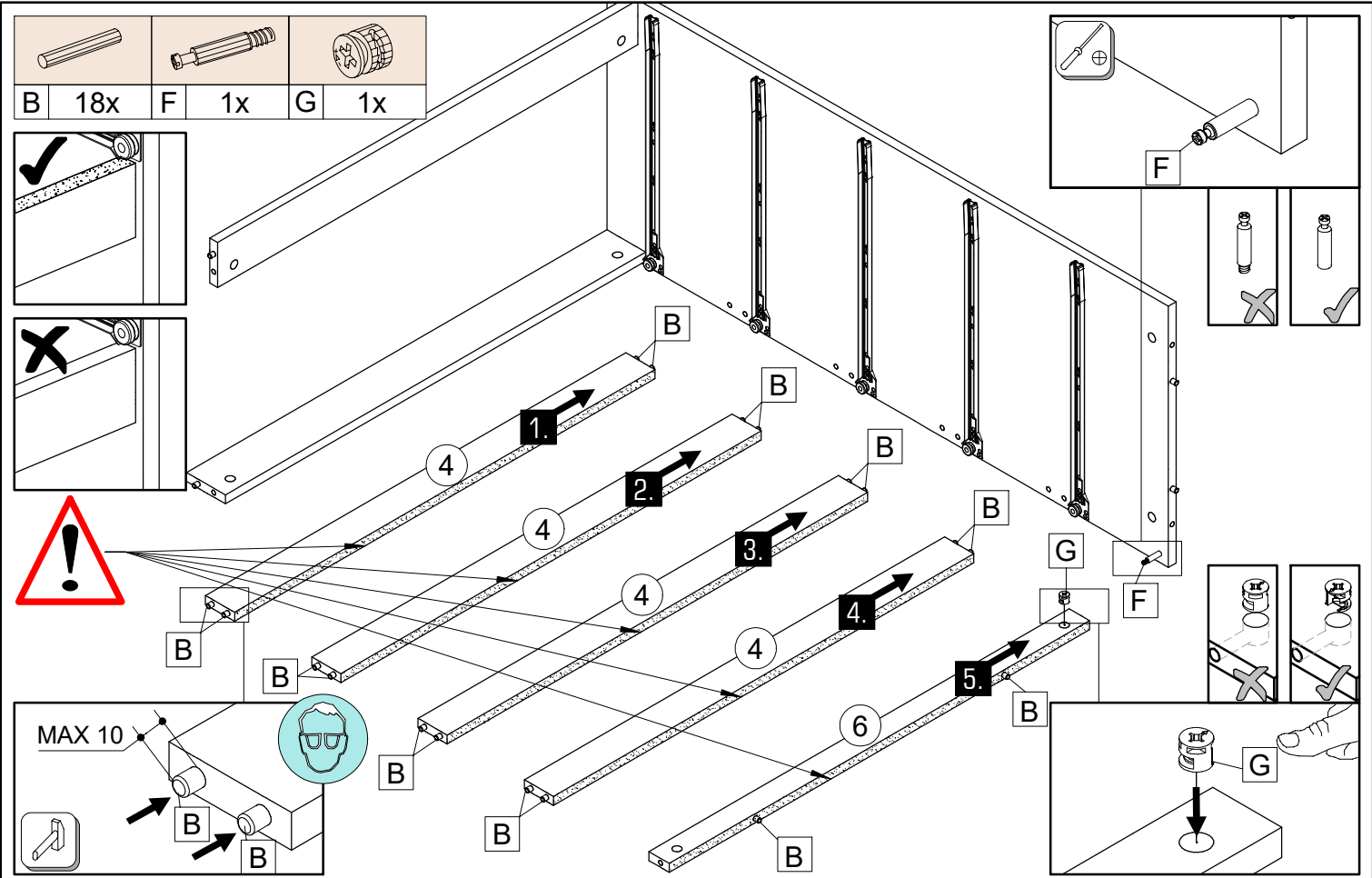
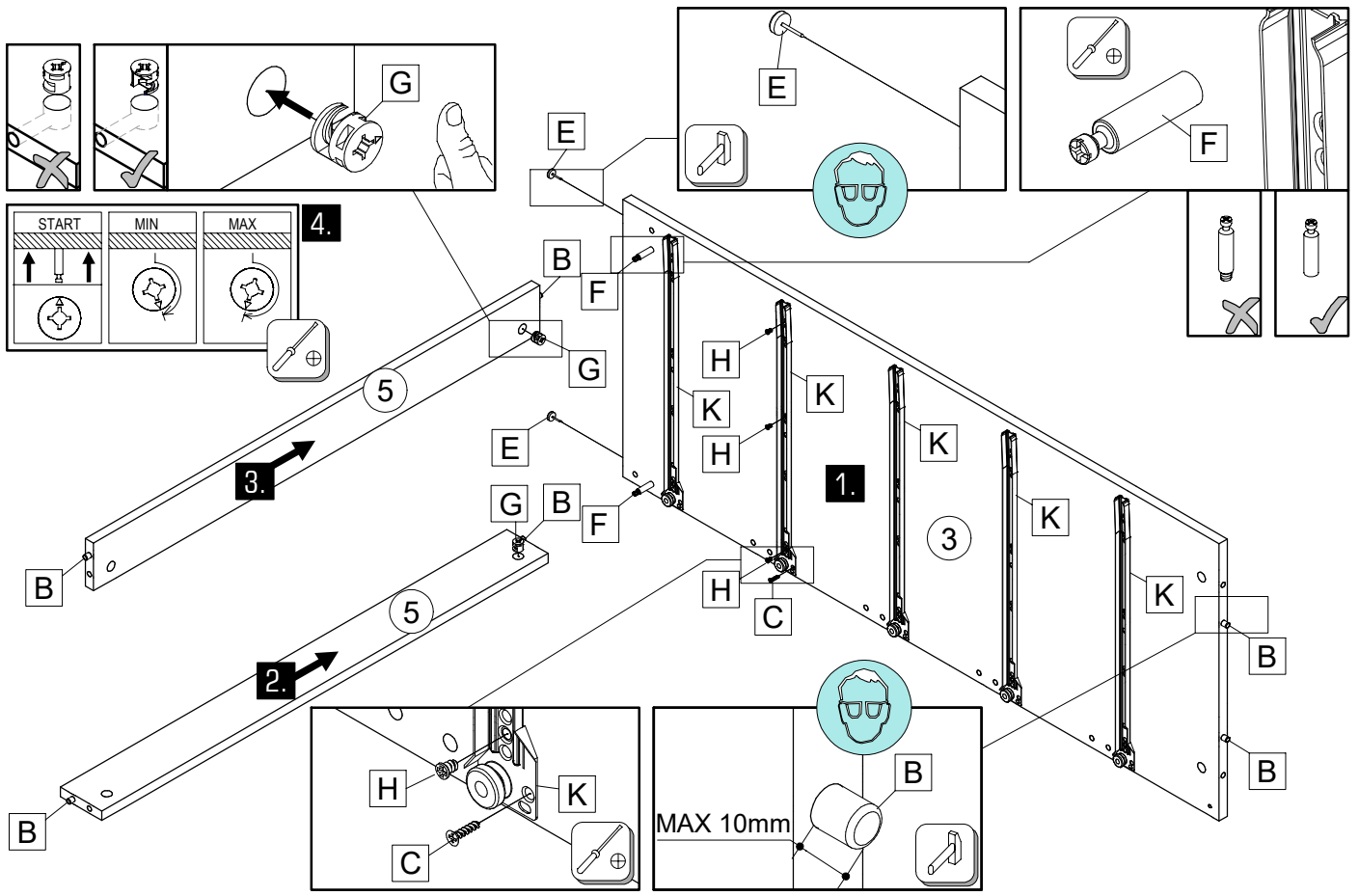

| | | | | | |
|----------|----------|----------|----------|----------|----------|
| 22300,00 | 27000,00 | 22243,00 | 21102,00 | 30091,00 | 70021,01 |
| A 20x | B 36x | C 40x | D 50x | E 4x | F 30x |
| 70013,01 | 22705,00 | 50553,00 | 33006,01 | 33006,01 | |
| G 30x | H 30x | J 20x | K 5x | L 5x | |

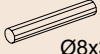

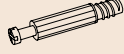





| | | | | | | |
|--|---|---|---|---|---|--|
|  |  |  |  |  |  |  |
| B 6x | C 5x | E 2x | F 2x | G 2x | H 15x | K 5x |





| | | | | | | |
|--|---|---|---|---|---|--|
|  |  |  |  |  |  |  |
| B 2x | C 5x | E 2x | F 3x | G 3x | H 15x | K 5x |

2.





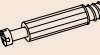

| | | |
|---|---|---|
|  |  |  |
| ↑ | ↓ | ↑ |
|  |  |  |

1.

MAX 10mm

| | |
|--|---|
|  |  |
| F 4x | G 4x |

2.

| | | |
|---|---|---|
|  |  |  |
| ↑ | ↓ | ↑ |
|  |  |  |

13.

2.

